



TELEDYNE LECROY
Everywhereyoulook™



QPHY-USB (1.0 / 1.1 / 2.0)
USB Serial Data Compliance Software
Instruction Manual

Revision B – November, 2017

Relating to:

XStreamDSO v.8.5.x.x and later

QualiPHY Software v.8.5.x.x and later



TELEDYNE LECROY
Everywhereyoulook™

700 Chestnut Ridge Road
Chestnut Ridge, NY, 10977-6499
Tel: (845) 578-6020, Fax: (845) 578 5985
teledynelecroy.com

© 2017 Teledyne LeCroy, Inc. All rights reserved.

Customers are permitted to duplicate and distribute Teledyne LeCroy documentation for internal training purposes. Unauthorized duplication is strictly prohibited.

Teledyne LeCroy and other product or brand names are trademarks or requested trademarks of their respective holders. Information in this publication supersedes all earlier versions. Specifications are subject to change without notice.

922534 Rev B
November, 2017

Table of Contents

Introduction	5
Tests Performed	5
Device Tests	5
Host Tests	5
Hub Tests	6
Required Equipment	6
Oscilloscope	6
Host Testbed Computer	7
Test Fixture and Probes	7
Additional Equipment	7
USB Test Fixture	8
Test Bed Computer	11
USB-IF Test Scripts	11
Installation and Setup	12
Oscilloscope Option Key Installation	12
Typical (Recommended) Configuration	12
Remote (Network) Configuration	12
QualiPHY Overview	13
Setting Up a Test Session	13
Report Generation	16
Customizing QualiPHY	18
Using the USB Test Wizard	20
General Setup	20
High-Speed Tests	25
Host and Hub Downstream High-Speed Signal Quality	25
Device and Hub Upstream High-Speed Signal Quality	26
High-Speed Packet Parameters	27
Host High-Speed Chirp Timing	28
Device and Hub High-Speed Chirp Timing	31
Host High-Speed Suspend Resume Reset Timing	32
Device or Hub High-Speed Suspend Resume Reset Timing	33
Host and Hub Disconnect	34
Hub High-Speed Upstream Repeater	36
Hub High-Speed Downstream Repeater	39
Receiver Sensitivity	41
Full and Low-Speed Tests	45
Required Equipment	45
Hub and Host Drop Test	47
Droop Test	49
Host Low-Speed Downstream Signal Quality	52
Host Full-Speed Downstream Signal Quality	54
Inrush Current	56
Hub Down Stream Low-Speed Signal Quality	57
Hub Full-Speed Downstream Signal Quality	58
Device and Hub Full-Speed Upstream Signal Quality Test	60
Device and Hub Full- or Low-Speed Upstream Signal Quality Test	61
TF-USB-B Test and Calibration Procedures	62
Cable Deskewing	Error! Bookmark not defined.
Receiver Sensitivity Test Waveform Setup	64
MIN_ADD1	64
IN_ADD1	64

Table of Figures

Figure 1. USB 2.0 Test Fixture (Part Number TF-USB-B)	8
Figure 2. TF-USB-B package	9
Figure 3. TF-USB-B Showing Power Supply Selection Jumper	10
Figure 4. Probe Connection Pins Showing Grounds	10
Figure 5. USB-IF HS Electrical Test Tool main menu	11
Figure 6. QualiPHY framework dialog and Standard selection menu	13
Figure 7. Example of pop-up message box	15
Figure 8. Example of pop-up connection diagram and dialog box	15
Figure 9. Report tab in QualiPHY General Setup	16
Figure 10. The Test Report Summary Table and Detail pages	17
Figure 11. QualiPHY Configuration and Test Selectors	18
Figure 12. Variable Setup and Limits tabs	19
Figure 13. Device test High-Speed Upstream Near End Signal Quality	21
Figure 14. USB camera connected to the Signal Quality section	21
Figure 15. Step 2 of 4: Probe Hookup	22
Figure 16. Two SMA Cables Connected to the Test Fixture	22
Figure 17. D600ST-SP Connected to the Test Fixture	23
Figure 18. Single-ended Probe Connection Example	23
Figure 19. Step 3 of 4: EL_2-EL_7 Signal Quality	24
Figure 20. HS Electrical Test Tool Setup for Device High-Speed Signal Quality	24
Figure 21. Signal Quality Host Section	25
Figure 22. Host High-Speed Downstream Signal Quality Analysis	25
Figure 23. Device High-Speed Upstream Signal Quality	26
Figure 24. Host High-Speed packet parameters trace	27
Figure 25. Chirp Response Time	28
Figure 26. Chirp J and Chirp K Duration	29
Figure 27. Chirp to Start of Frame Time	30
Figure 28. Chirp K Latency	31
Figure 29. Time from Last Start of Frame to Host Suspend	32
Figure 30. Time from Last Start of Frame to Device Suspend	33
Figure 31. Host Disconnect Section of Test Fixture	34
Figure 32. Initial voltage before disconnect	34
Figure 33. Voltage after disconnect	35
Figure 34. Hub and Device Fixture Connections for Upstream Repeater Test	36
Figure 35. Initial signal acquisition for hub upstream repeater test	36
Figure 36. Hub upstream repeater sync field truncation and corruption	37
Figure 37. Hub upstream repeater end of packet dribble	37
Figure 38. Hub upstream repeater delay	38
Figure 39. Hub and Device Fixture Connections for Downstream Repeater Test	39
Figure 40. Hub downstream repeater delay	39
Figure 41. Hub downstream repeater sync field truncation and corruption	40
Figure 42. Hub downstream repeater end of packet dribble	40
Figure 43. Receiver Sensitivity Test Setup	41
Figure 44. Use Device Command drop down list of HS Electrical Test Tool	42
Figure 45. Response to IN tokens with 12-bit sync - all packets NAK'd	42
Figure 46. Intermittent Response to IN tokens at low amplitude	43
Figure 47. Receiver squelch level – no response to IN tokens	44
Figure 48. FS/LS Signal Quality Test Fixture Sections	46
Figure 49. Bus-Powered Hub Drop test equipment setup	47
Figure 50. Hub Droop Test Equipment Setup	49
Figure 51. Device and oscilloscope connections for droop test	49
Figure 52. Droop voltage waveform	50
Figure 53. Host Low-Speed Downstream Signal Quality Test Equipment Setup	52
Figure 54. Cursor Positioning for Host Low-Speed Signal Quality Test	53
Figure 55. Host Full-Speed Downstream Signal Quality Test Equipment Setup	54

Figure 56. Cursor Positioning for Host Full-Speed Downstream Signal Quality..... 55
Figure 57. Inrush Current Pulse 56
Figure 58. Hub Low-Speed Downstream Signal Quality Setup 57
Figure 59. Hub Full-Speed Downstream Signal Quality Setup 58
Figure 60. Cursor Placement For Hub FS Downstream Signal Quality Test 59
Figure 61. Device Full-Speed Upstream Signal Quality Test Equipment Setup 60
Figure 62. Isolation of Upstream Data Packet 61

About This Manual

This manual assumes that you are familiar with using an oscilloscope—in particular the Teledyne LeCroy oscilloscope that will be used with QualiPHY—and that you have purchased the QPHY-USB software option.

Some of the images in this manual may show QualiPHY products other than QPHY-USB, or were captured using different model oscilloscopes, as they are meant to illustrate general concepts only. Rest assured that while the user interface may look different from yours, the functionality is identical.

Introduction

QPHY-USB is an automated test package that performs all the required tests from the USB-IF for physical layer compliance of USB hosts, hubs, and devices up to High Speed (USB 2.0) specifications.

The software is compatible with any Teledyne LeCroy real-time oscilloscope with at least 2 GHz bandwidth.

This manual covers the use of both QualiPHY for compliance testing and the oscilloscope's embedded test tools for debugging.

- Users interested in compliance testing should begin by using QualiPHY.
- Users interested in debugging circuits should begin by using the oscilloscope's embedded test tools.
- Users that begin by using QualiPHY and detect failures on their device then have the option of switching to the oscilloscope's embedded test tools for debugging.

Tests Performed

The software and fixture combine to perform the following measurements for USB hosts, hubs, and devices.

Device Tests

- HS Upstream Signal Quality
 - Far-end for tethered hubs
 - Near-end for un-tethered hubs
- HS Packet Parameters
- HS Chirp Timing
- HS Suspend / Resume / Reset
- HS Upstream J and K Voltages
- HS Upstream Receiver Sensitivity
- FS Upstream Signal Quality
- LS Upstream Signal Quality
- Inrush current
- Back-Voltage

Host Tests

- HS Downstream Signal Quality
- HS Downstream Packet Parameters
- HS Downstream Chirp Timing
- HS Downstream Suspend / Resume / Reset
- HS Downstream Disconnect
- HS Downstream J and K Voltages
- FS Downstream Signal Quality
- LS Downstream Signal Quality
- Drop
- Droop

Hub Tests

- HS Signal Quality (Upstream/Downstream)
- HS Upstream Packet Parameters
- HS Upstream Chirp Timing
- HS Upstream Suspend / Resume / Reset
- HS Disconnect
- HS J and K Voltages (Upstream/Downstream)
- HS Upstream Repeater
- HS Downstream Repeater
- HS Upstream Receiver Sensitivity
- FS Signal Quality (Upstream/Downstream)
- LS Signal Quality (Upstream/Downstream)
- Inrush current
- Drop
- Droop
- Back-Voltage

In the previous tests, the J and K Voltages tests are performed with the use of a digital voltmeter. This test is performed for Hosts, Devices, and Hubs.

Required Equipment

The following equipment is required for High-Speed, Full-Speed, and Low-Speed USB testing using QPHY-USB.

Oscilloscope

Teledyne LeCroy real-time oscilloscope, ≥ 2 GHz BW, installed with:

- XStreamDSO v.7.2.x.x minimum* with an activated QPHY-USB option key
- QualiPHY software v.7.2.x.x minimum with an activated QPHY-USB component
- MATLAB Component Run-Time**

***Note:** The version of XStreamDSO and QualiPHY software must match, so upgrade your version of QualiPHY if you have upgraded your oscilloscope firmware. The versions listed above are the minimum versions required for this product. QualiPHY software may be installed on a remote PC, but all other software must be installed on the oscilloscope.

****Note:** Effective with X-StreamDSO version 4.3.1, the Teledyne LeCroy USB2.0 test suite requires the installation of the MATLAB Component Run-time on the oscilloscope even if there is a full installation of the MATLAB software already on the machine. The MATLAB Component Run-time can be downloaded from teledynelecroy.com. MATLAB scripts are used to perform signal quality and inrush tests. If the MATLAB Component Run-time is not properly installed on the oscilloscope, the tests requiring these scripts are disabled.

Host Testbed Computer

A PC is required for Host tests and to place DUT into the required test modes. It should be installed with:

- Windows 10 or Windows 7 Professional
- USB High-Speed Electrical Test Tool software (USBHSET)

Test Fixture and Probes

- USB test fixture (TF-USB-B)
- 2 GHz or higher bandwidth active differential probe (WL300/D350ST-SP) [for HS tests]
 - WL600/D600ST-SP recommended (but not mandatory) for WM-class oscilloscopes
 - A second differential probe is required for Hub testing
- 2 GHz (or higher) active probe (HFP2500, 2 ea.) [for HS/FS/LS tests]
- 1.5 GHz (or lower) active probe (HFP1500) or passive probe (PP006A or equivalent) [for FS/LS tests]
 - PP00x passive probe will require AP-1M adapter for WM-class oscilloscopes
- 30A or lower Current probe (CP030) [for B.4 Inrush test only]
 - Adapter (AP-1M) required for WM-class oscilloscopes

Additional Equipment

- Certified High-Speed USB self-powered hub (4 ea.) [for FS/LS tests]
- Certified Full-Speed USB self-powered hub [for FS/LS tests]
- 5 meter USB cables type-A to type-B male (6 ea.) [for FS/LS tests]
- 1 meter USB cables type-A to type-B male (up to 12, depending on hub under test) [for HS/FS/LS tests]
- Certified Low-Speed trigger device (e.g. USB mouse) [for LS tests]
- Certified Full-Speed (or High-Speed) trigger device (e.g. USB memory stick or web camera) [for FS tests]
- Certified High-Speed trigger device (can be used as the FS Certified device) [for HS tests]
- Digital Voltmeter 3 ½ digits (Keithley 2000 multimeter or equivalent) [for HS/FS/LS tests]
- Data Pattern Generator (e.g. 2 x Tabor WW1281A with synchronization cable) [for HS tests]
- USB host system [for HS/FS/LS tests]

USB Test Fixture

The USB test fixture (TF-USB-B) is required to perform compliance tests. The fixture consists of several sections designed to allow connection to the electrical signal under test. Each section is marked on the fixture, and the ports on each section are also labeled. The section and port(s) to use for a given test are called out in the procedure on the instrument display and in this manual.

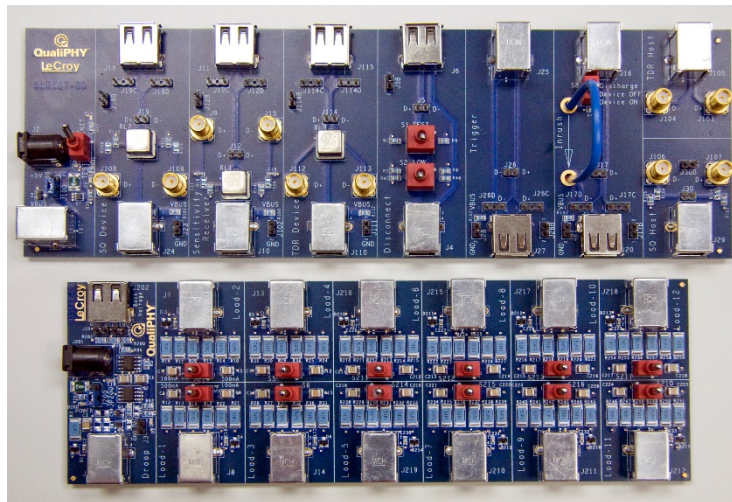

Figure 1. USB 2.0 Test Fixture (Part Number TF-USB-B)

The TF-USB-B package is delivered in a black plastic case with a foam insert.

TF-USB-B Standard supplied items

- 1 x safety sheet (# 915235-00)
- 1 x TF active section (# 915189-00)
- 1 x TF loads section (# 915190-00)
- 1 x USB cable (to power the Test Fixture)
- 2 x 50 Ω terminator
- 2 x SMA cables
- 2 x BNC-to-SMA adapter
- 1 x MultiWrench
- 5 x 6" USB cable A-male to B-male
- 1 x USB adapter A-female to B female
- 1 x USB adapter A-male to mini-B male

Note: SMA and USB connectors are not rated for repetitive make/break connections. Use of this fixture for high volume manufacturing should utilize an appropriately rated intermediate contact fixture.



Figure 2. TF-USB-B package

The fixture requires a 5 V power supply for operation. The fixture can be supplied from either a DC adapter or USB port and is selectable from a jumper on the fixture. When the jumper is placed over pins 2 and 3, the power is supplied from the USB port (default setting); when placed over pins 1 and 2, the power is supplied from the DC adapter. The following figure shows the jumper set so the board receives power from the USB port.

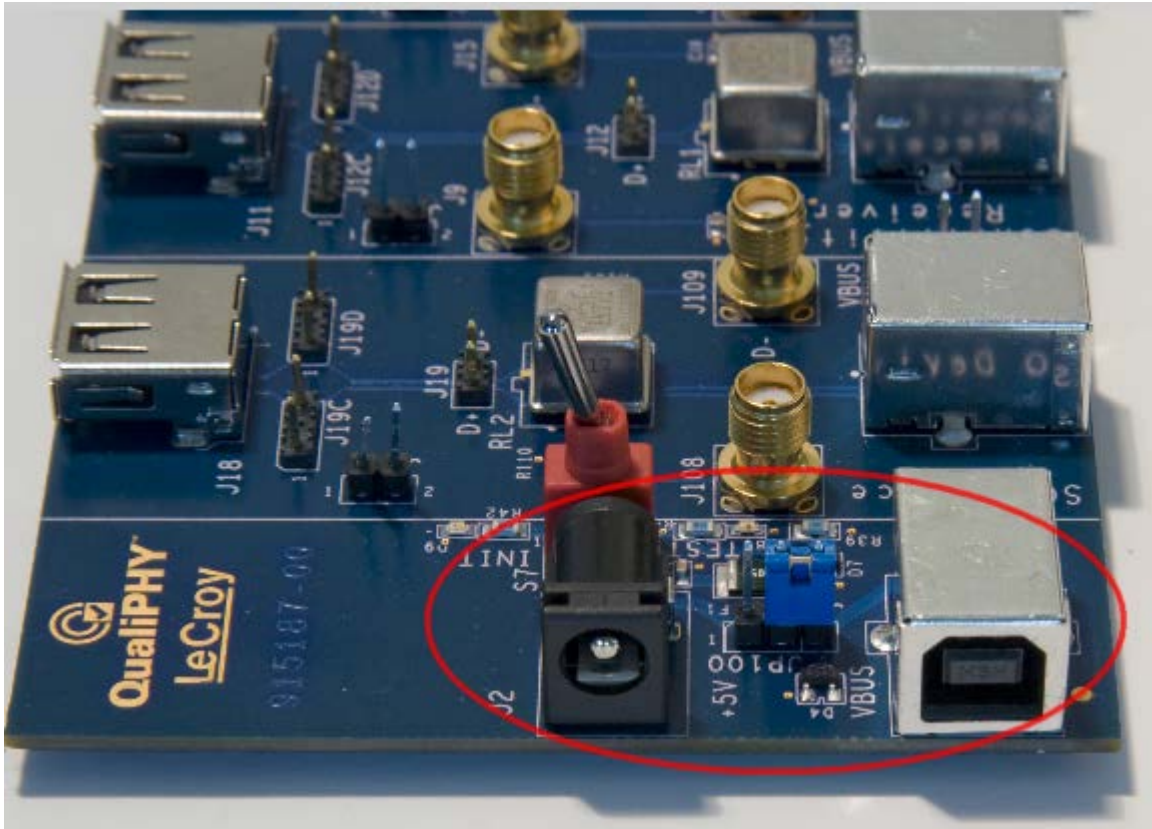

Figure 3. TF-USB-B Showing Power Supply Selection Jumper

The USB test fixture has square pins that provide connection points for differential and single-ended probes. The pins are connected to the “+” and “-” signal lines and a pair of ground pins are also provided.

Note: Use probes as indicated. All unnecessary probes for a given test must be removed.

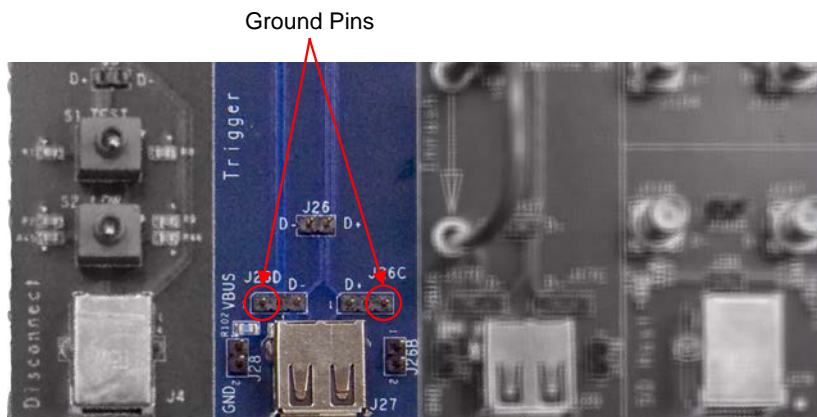

Figure 4. Probe Connection Pins Showing Grounds

Test Bed Computer

A host computer with a USB2.0 controller card is required to place the device under test (DUT) into the necessary test modes. This computer must be running Windows 7 or Windows 10 Professional, and have the USB-IF High-Speed Electrical Test Toolkit (USBHSET) installed. The instructions in the Teledyne LeCroy test package prompt to execute specific functions within the USB High-Speed Electrical Test Toolkit on the host computer for various tests. Best practice is to use an external host computer, separate from the oscilloscope, as the test bed computer.

Both the USBET and the USBHSET can be downloaded from the USB-IF Web site at the following address:

<http://www.usb.org/developers/tools/>

The test package has been validated with version 1.1.0.4 of the USBHSET.

Open the HS Electrical Test Tool as follows: **Windows Start Menu → Programs → USB-IF Test Suite → USB HS Electrical Toolkit → HSElectricalTestTool.**

The main menu is then shown as follows.

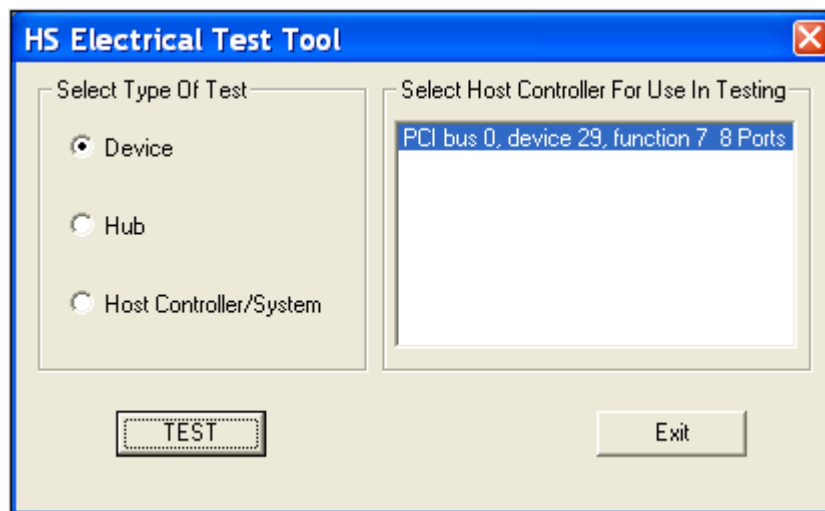

Figure 5. USB-IF HS Electrical Test Tool main menu

Note: All USB devices are disabled when the HS Electrical Test Toolkit is started. Functionality is restored upon exiting the Test Tool menu. This means that during this process, **a USB mouse and/or keyboard are disabled.**

If a USB 2.0 host is found, it appears on the list box control. If no host is found either there is no USB 2.0 host or the driver is not functioning correctly.

Note: If the USB-IF supplied HS Electrical Test Tool stops working and does not exit normally, open the Device Manager and remove all the USB hosts, devices, and hubs, and then reboot the computer.

USB-IF Test Scripts

The test package uses USB-IF written test scripts specifically made to analyze test data acquired by the oscilloscope. These scripts are also released by the USB-IF as a stand-alone program called the USB Electrical Analysis Tool (USBET).

Installation and Setup

Oscilloscope Option Key Installation

An option key must be purchased to enable the QPHY-USB option. Call Teledyne LeCroy Customer Support to place an order and receive the code.

Enter the key and enable the purchased option as follows:

1. From the oscilloscope menu select **Utilities** → **Utilities Setup...**
2. Select the **Options** tab and click the **Add Key** button.
3. Enter the **Key Code** using the on-screen keyboard.
4. Restart the oscilloscope to activate the option after installation.

Typical (Recommended) Configuration

QualiPHY software can be executed from the oscilloscope or a host computer. The first step is to install QualiPHY.

Teledyne LeCroy recommends running QualiPHY on an oscilloscope equipped with Dual Monitor Display capability. This allows the waveform and measurements to be shown on the oscilloscope LCD display while the QualiPHY application and test results are displayed on a second monitor.

By default, the oscilloscope appears as a local host when QualiPHY is executed in the oscilloscope. Follow the steps under Error! Reference source not found. (as follows) and check that the IP address is 127.0.0.1.

Remote (Network) Configuration

It is also possible to install and run QualiPHY on a remote host computer, controlling the oscilloscope over a Network/LAN Connection. An IP address (fixed or dynamic) must already be established on the oscilloscope.

Set up the oscilloscope to use QualiPHY over a LAN by doing the following:

1. Make sure the host computer is connected to the same subnet as the oscilloscope. If unsure, contact your system administrator.
2. From the oscilloscope menu, select **Utilities** → **Utilities Setup...**
3. Select the **Remote** tab.
4. Verify the oscilloscope has an IP address and the control is set to TCP/IP.
5. Run QualiPHY in the host computer and click the **General Setup** button.
6. Select the **Connection** tab.
7. Enter the IP address from step 4 (previous).
8. Click the **Close** button.

QualiPHY is now ready to control the oscilloscope.

QualiPHY tests the oscilloscope connection after clicking the **Start** button. The system prompts you if there is a connection problem. QualiPHY's **Scope Selector** function can also be used to verify the connection.

QualiPHY Overview

QualiPHY is Teledyne LeCroy's unique compliance test framework, which guides the user step-by-step through the compliance tests. QualiPHY displays connection diagrams to ensure tests run properly, automates the oscilloscope setup.

The Teledyne LeCroy QPHY-USB package displays all parameters for each measurement on the instrument screen along with pass/fail indicators and appropriate waveforms. Print the screen by using the oscilloscope hardcopy feature.

Setting Up a Test Session

Access the QPHY-USB software using the following steps:

1. Wait for the oscilloscope to start and have its main application running.
2. Launch QualiPHY from the **Analysis** menu if installed on the oscilloscope or from the desktop icon if installed on a host computer.
3. From the QualiPHY framework dialog, select **Standard**, then **USB** from the pop-up menu.
4. If you check the **Pause on Failure** box, QualiPHY prompts to retry the measure whenever a test fails.

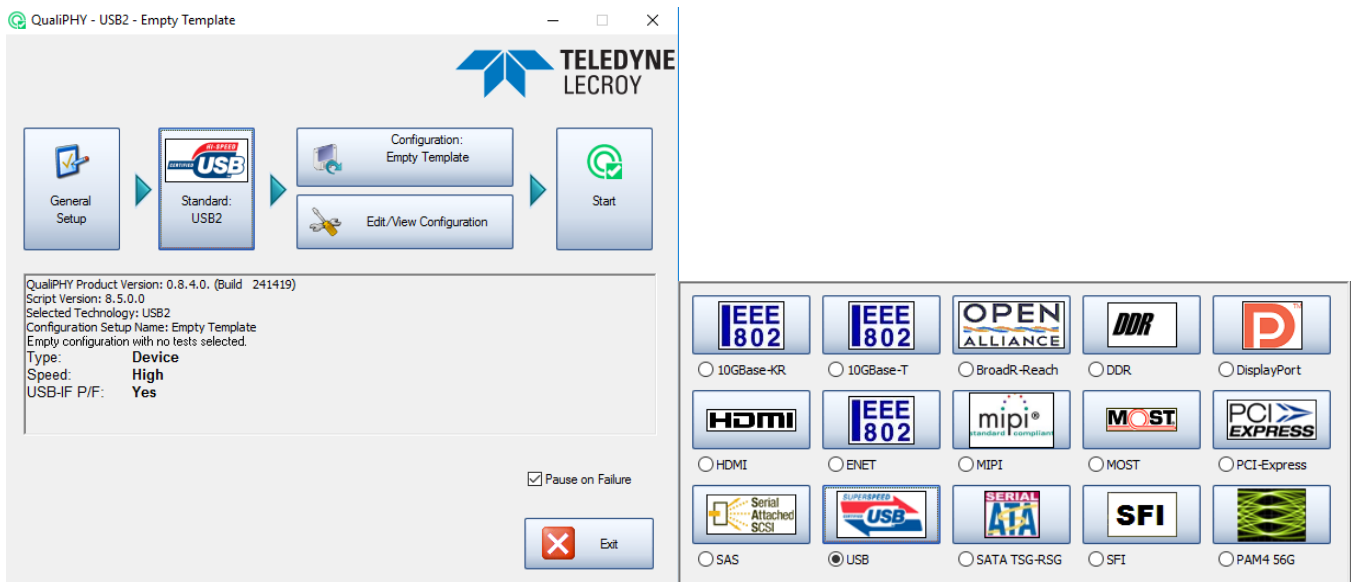
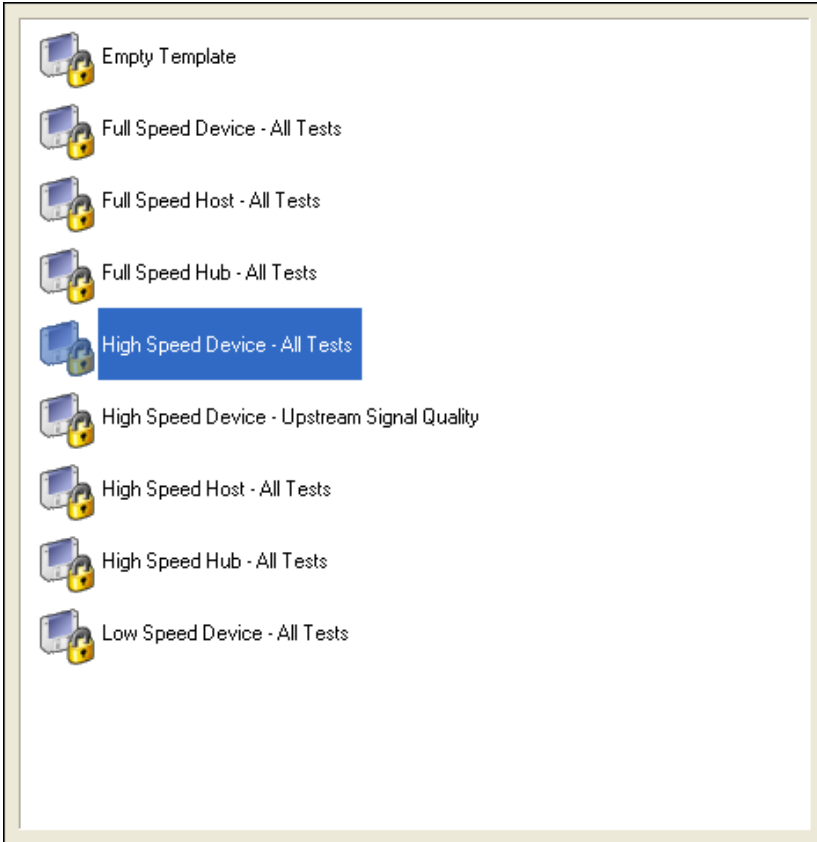

Figure 6. QualiPHY framework dialog and Standard selection menu

5. Click the **Configuration** button on the framework dialog:



6. Select a configuration from the pop-up menu:



7. Click **Start**.



8. After pressing **Start** in the QualiPHY menu, the software instructs you how to set up the test using pop-up connection diagrams and dialog boxes. Follow the prompts.

QualiPHY also instructs how to properly configure the USB-IF HS Electrical Test Toolkit to change test signal modes (when necessary).

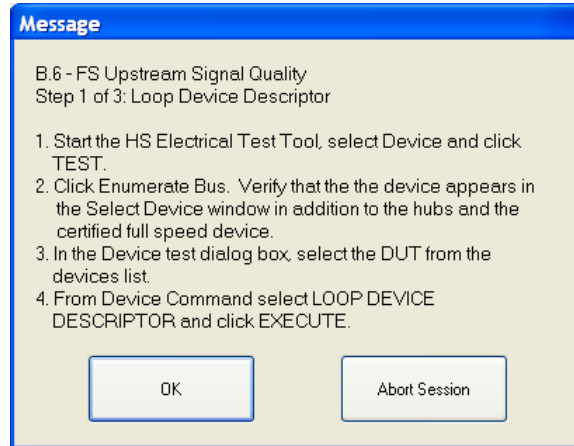

Figure 7. Example of pop-up message box

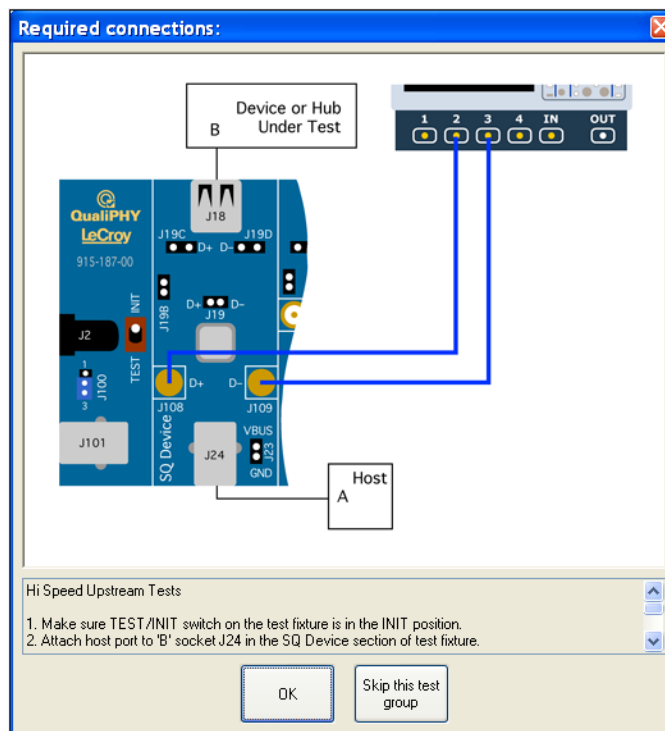

Figure 8. Example of pop-up connection diagram and dialog box

Report Generation

The QualiPHY software application automates report generation following each test.

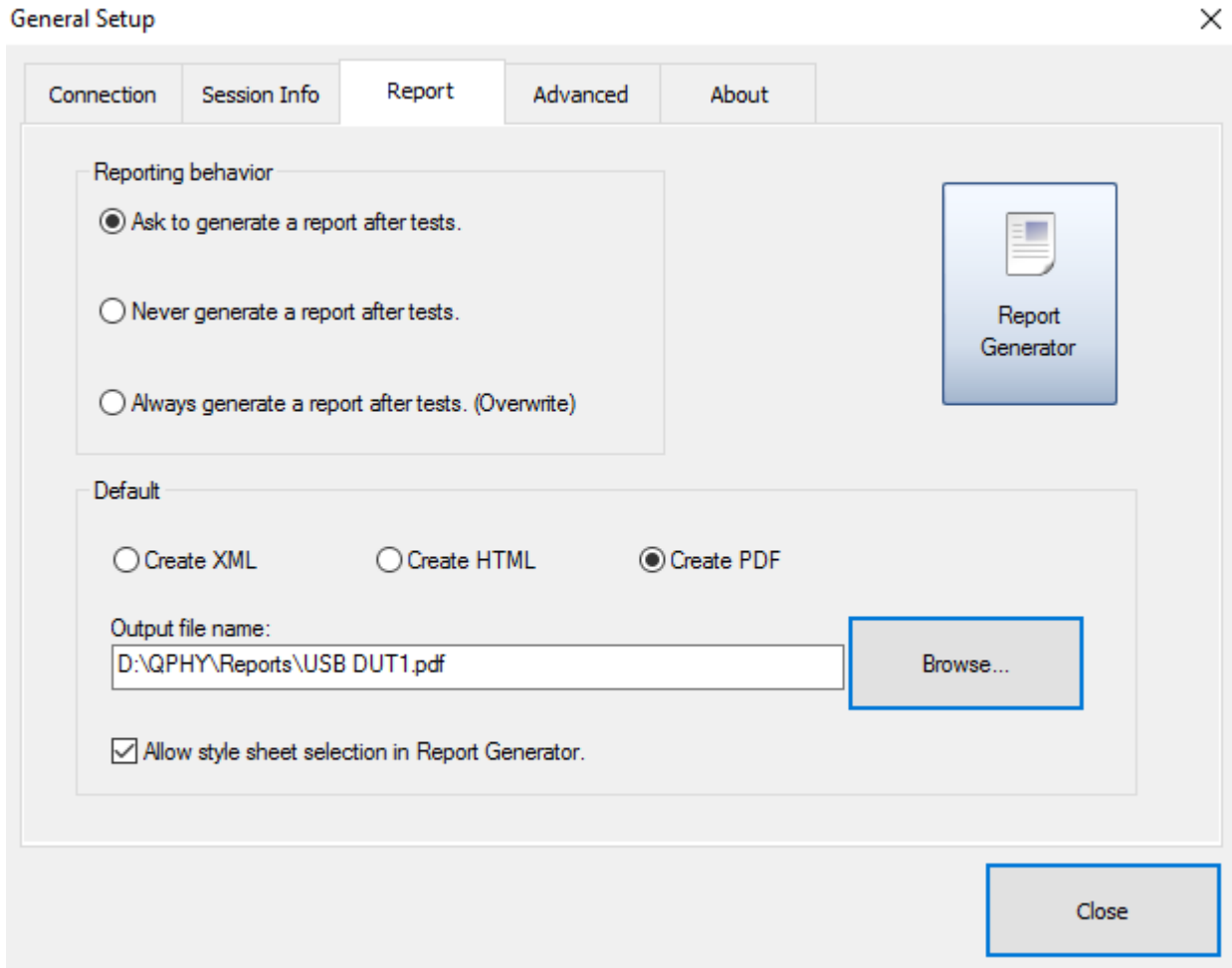

Figure 9. Report tab in QualiPHY General Setup

Reports are output to the folder D:\QPHY\Reports, or C:\LeCroy\QPHY\Reports if QualiPHY is installed on a remote PC.

You can add your own logo to the report by replacing the file *\\QPHY\\StyleSheets\\CustomerLogo.jpg.

The recommended maximum size is 250x100 pixels at 72 ppi, 16.7 million colors, 24 bits. Use the same file name and format.

Reports include a Summary Table of all test results with hyperlinks to Details pages. The Details pages include a screen capture of the test, where relevant.



USB Test Report

Overall result: **Pass**

DUT: Memorex
 Comment:
 Time of test: 09/25/2007 14:10:34
 Operator: CB
 Temperature: 23° C
 Configuration in use: Hi Speed Device - All Tests
 Limits in use: USB Limits
 Standard in use: USB
 Oscilloscope Name: LCRY0608M13792 Model: WR2040
 Oscilloscope Serial #: LCRY0608M13792
 Computer: CBUSSO-NB
 Oscilloscope firmware version: 0.5.2.0 (Build 98265)
 QualiPHY core version: 5.1.3.3 (Build 97795)
 QualiPHY script version: 0.9.3
 Stylesheet version: 1.0
 Pass/Fail From USB/FScript: Yes
 Record More Screens: Yes
 Starting Port Number: 1
 USB-F Matlab script version: 2.21.00

Summary Table

[\[Hide Table\]](#)

Pass	Test	Speed	Direction	Port	Measurement	Current Value	Test Criteria
✓	EL_<2,4,6,7>	Hi	Upstream	-	Overall HS Signal Quality Result	Pass	Pass/Waiver
✓	EL_2	Hi	Upstream	-	HS Signal Rate Result	Pass	Pass/Waiver/NA
?	EL_2	Hi	Upstream	-	HS Signal Rate	479.98570 Mbits	Informational Only
✓	EL_4	Hi	Upstream	-	HS Signal Eye Result	Pass	Pass/Waiver/NA
?	EL_4	Hi	Upstream	-	HS Signal Eye Violations	0	Informational Only
?	EL_4	Hi	Upstream	-	HS Eye Exceptions	No transition exceptions	Informational Only
?	EL_4	Hi	Upstream	-	HS Consecutive Alter. Min	-42.600 ps	Informational Only
?	EL_4	Hi	Upstream	-	HS Consecutive Alter. Max	50.690 ps	Informational Only
?	EL_4	Hi	Upstream	-	HS RMS Alter.	20.729 ps	Informational Only

✓	B.4	na	Upstream	crush Charge	12 µC	< 50 µC
---	-----	----	----------	------------------------------	-------	---------

Details

*** Device Upstream Tests ***

B.6.4 - FS US Signal Quality

EL_<2,4,6,7> - HS Device Near End Signal Quality

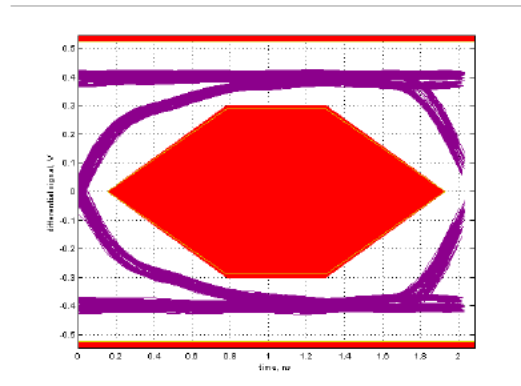

Upstream Eye Diagram, Path on Scope: D:\Applications\USB2 IResults\Qusb8Eye.png
 Timestamp: 09/25/2007 14:28:46

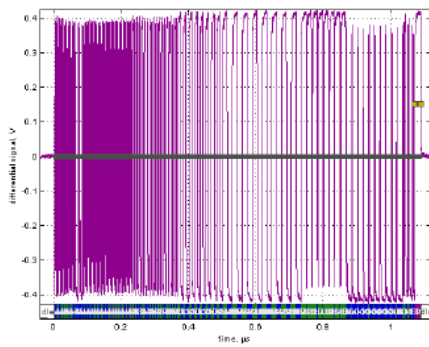

Scope Capture Data Plot, Path on Scope: D:\Applications\USB2 IResults\Qusb8Plot.png
 Timestamp: 09/25/2007 14:28:47

USBIF Report - Click below to view [click here to view](#)

✓	Pass	Measurement: Overall HS Signal Quality Result Limit Name: Pass/Match/Strict Current Value: Pass Test Criteria: Pass/Waiver Timestamp: 09/25/2007 14:28:50 Direction: Upstream Portname: Speed: Hi	[Link]
---	------	---	------------------------

✓	Pass	Measurement: HS Signal Rate Result Limit Name: Pass/Match Current Value: Pass Test Criteria: Pass/Waiver/NA	[Link]
---	------	---	------------------------

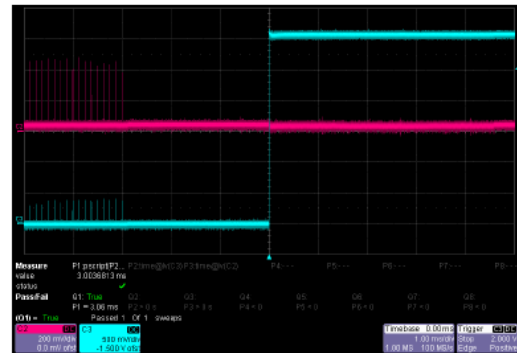

EL_38 HS Suspend Timing
 Timestamp: 09/25/2007 14:43:42

Test EL_39 - Hi Speed Suspend D Voltage

✓	Pass	Measurement: Suspend D- Volts Limit Name: SuspendDMinusVoltage Current Value: -1.7 mV Test Criteria: ≤ 700.0 mV Timestamp: 09/25/2007 14:43:47 Direction: Upstream Portname: Speed: Hi	[Link]
---	------	--	------------------------

✓	Pass	Measurement: Suspend D+ Volts Limit Name: SuspendDPlusVoltage Current Value: 3.05 V Test Criteria: 2.70 V ≤ V ≤ 3.60 V Timestamp: 09/25/2007 14:43:48	[Link]
---	------	--	------------------------

Figure 10. The Test Report Summary Table and Detail pages

Customizing QualiPHY

The predefined configurations in the **Configuration** screen cannot be modified. However, you can create your own test configurations by copying one of the standard test configurations and making modifications. A description of the test is also shown in the description field when selected.

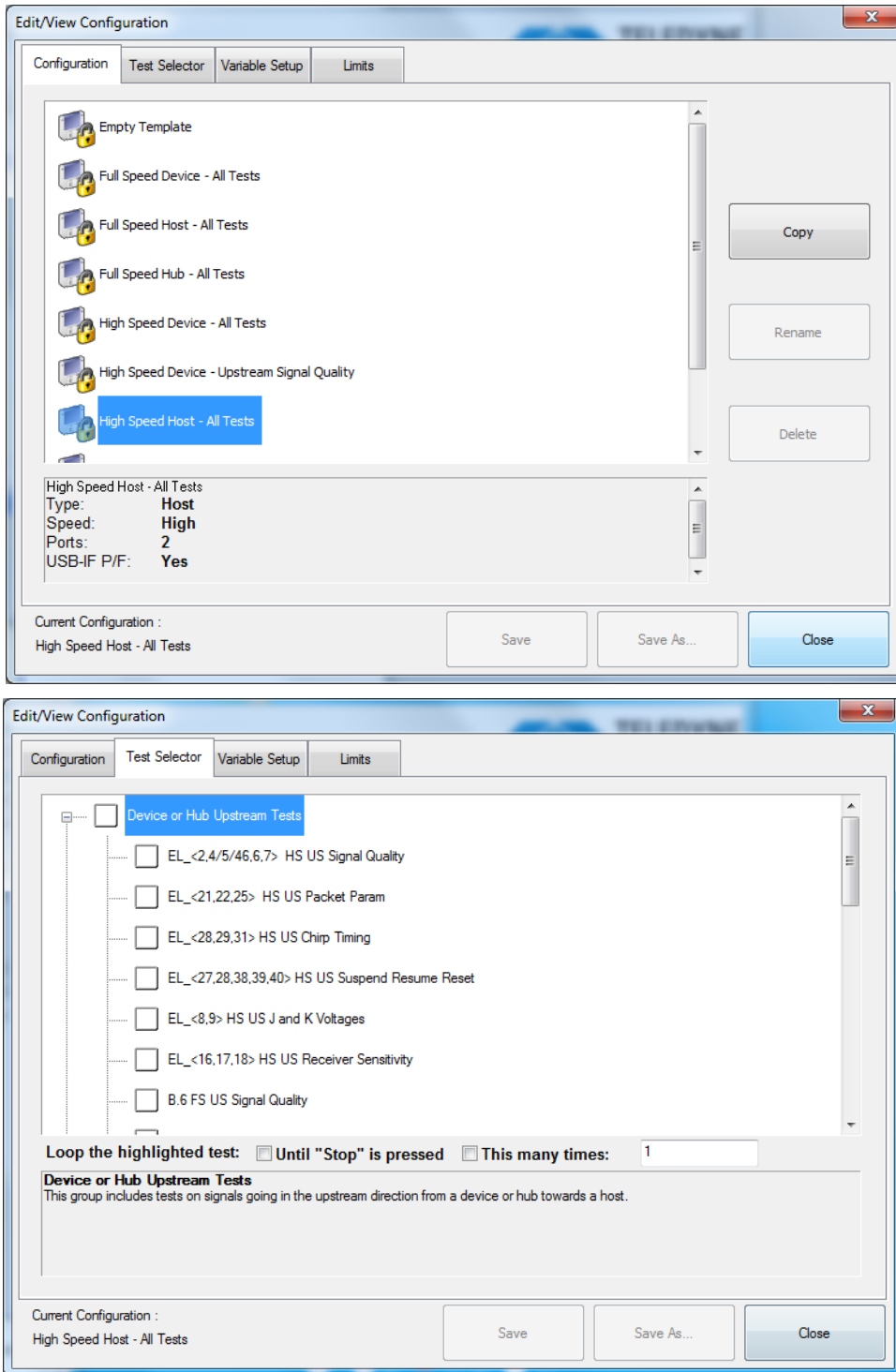

Figure 11. QualiPHY Configuration and Test Selectors

Once a custom configuration is defined, script variables and the test limits can be changed by using the **Variable Setup** and **Limits Manager** from the **Edit/View Configuration** window.

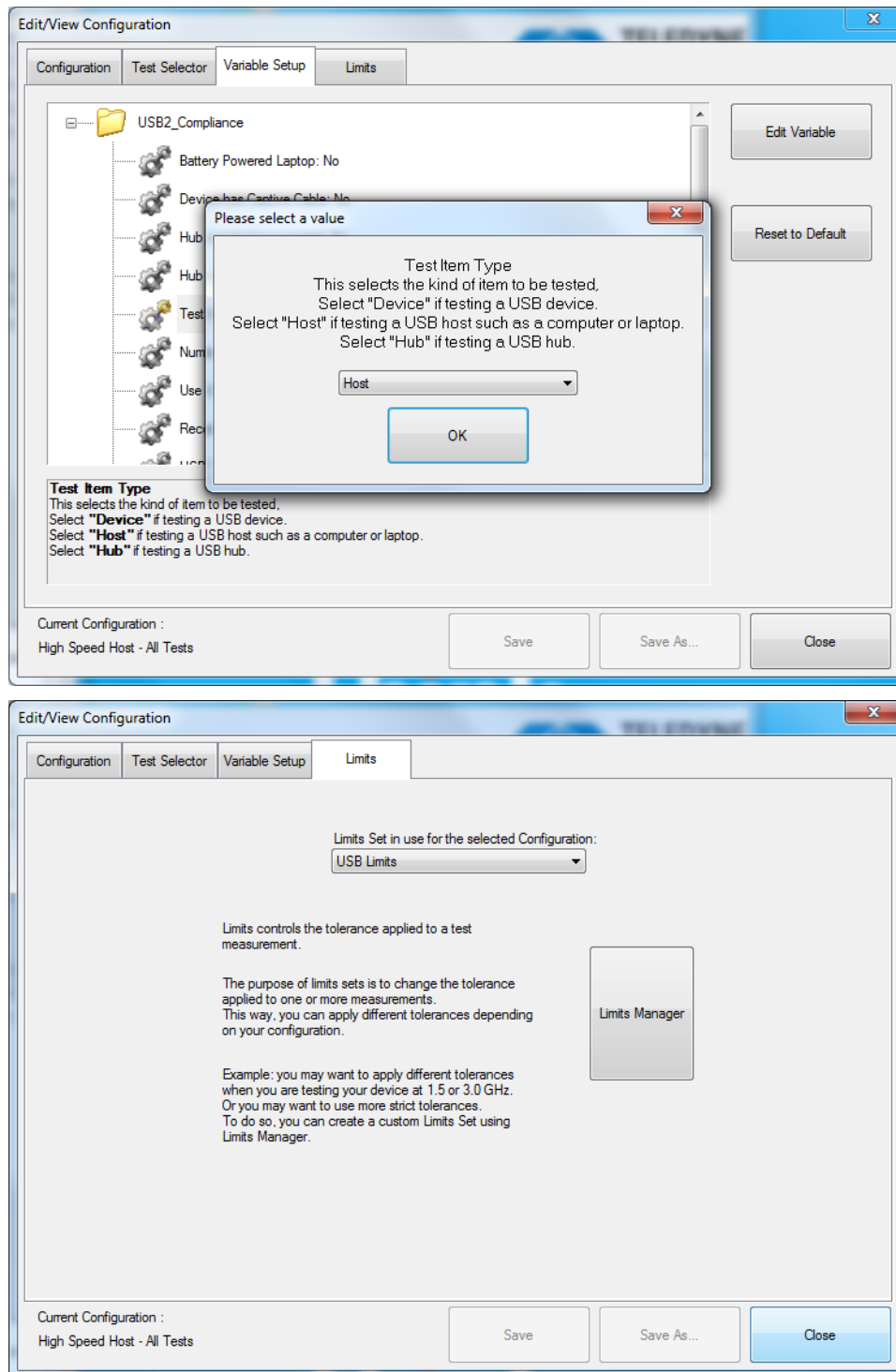
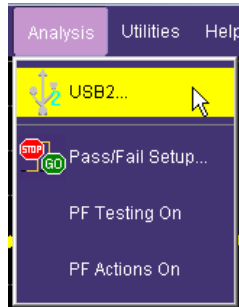

Figure 12. Variable Setup and Limits tabs

Using the USB Test Wizard

The Teledyne LeCroy USB Test Software (USB2) provides a wizard to direct users through the compliance test procedure for hosts, hubs, and devices. The USB Test Wizard is activated by selecting USB2 from the Analysis menu of the oscilloscope:



General Setup

The following wizard dialog page asks for **Mode** and **Test** control setup information, and then guides the user through the test. The **Mode** refers to the type of product being tested: Host, Hub or Device. Tests must be followed step by step. Following the instructions closely guarantees the correct operation of the test. Once a test is selected from the **Test** field, the instruction resets to Step 1.

- Use the **Next** button to proceed to the next step.
- Use the **Back** button to return to the previous step.
- Use the **Reset** button to start the selected test over again from Step 1.

In the Result File Name field, the directory in which the result file is stored can be changed by using the Browse button. The default directory is D:\Applications\USB2\Results\.

A Probe selection must be made to perform certain tests. Select the measurement method in the **Probe** field between **Differential** (to use a differential probe) and **2 Cables** (to use 2 SMA cables). The 2 Cables method should be used for measuring signal quality with the TF-USB-B fixture (please refer to the Deskewing topic of this manual for more details). The Differential probe method is to support old fixtures that do not have SMA connectors. Some tests do not offer a probe selection and must use a differential probe. For those tests which use the **Signal Quality** sections of the test fixture with a differential probe the SMA connectors must be terminated.

Step 1 - Hooking up the USB device, host, and cables to the USB test fixture:

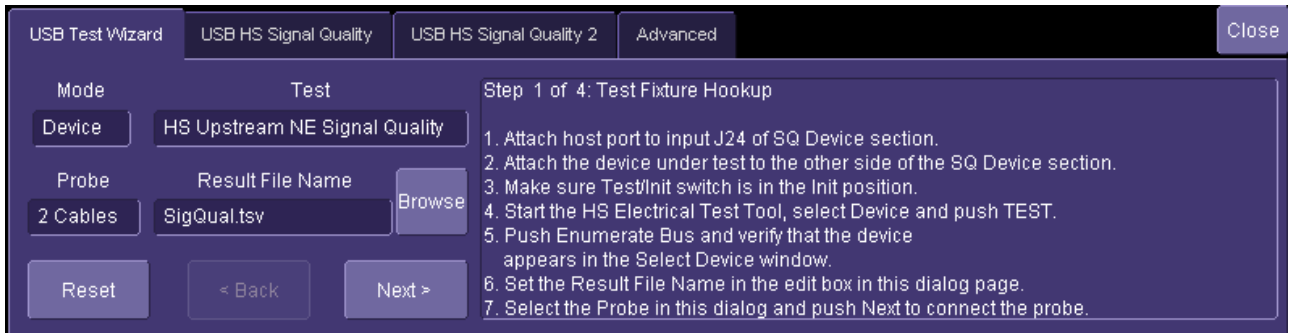

Figure 13. Device test High-Speed Upstream Near End Signal Quality

The following image shows a USB device (camera) connected to the SQ Device section of the test fixture (left), while the host cable is connected to input J24 (right).

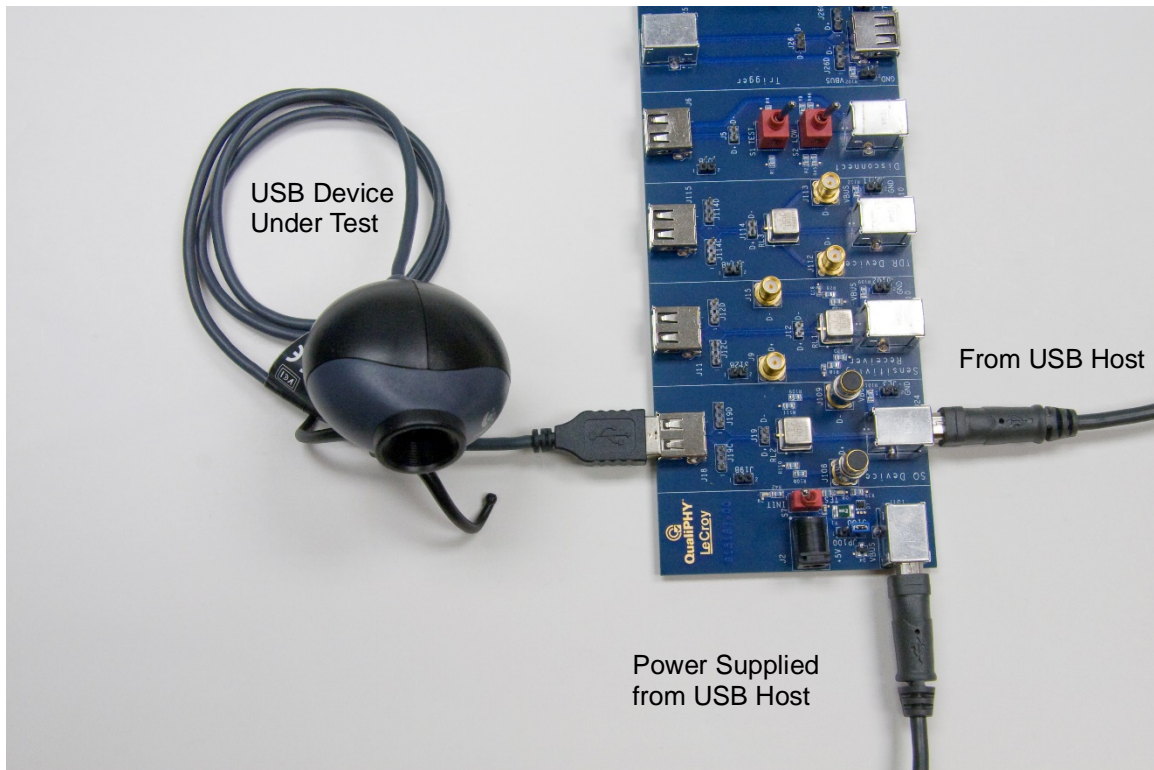

Figure 14. USB camera connected to the Signal Quality section

Step 2 - Connects the 2 SMA cables between the oscilloscope and the test fixture:

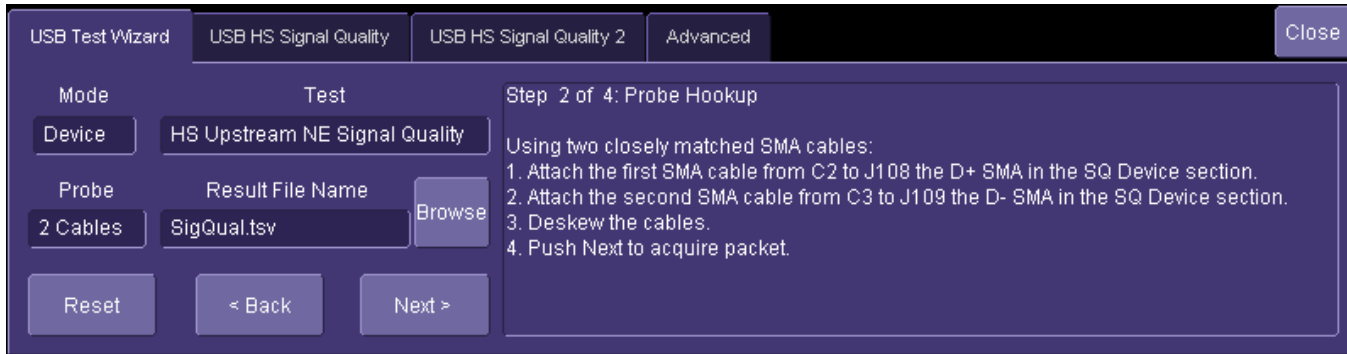

Figure 15. Step 2 of 4: Probe Hookup

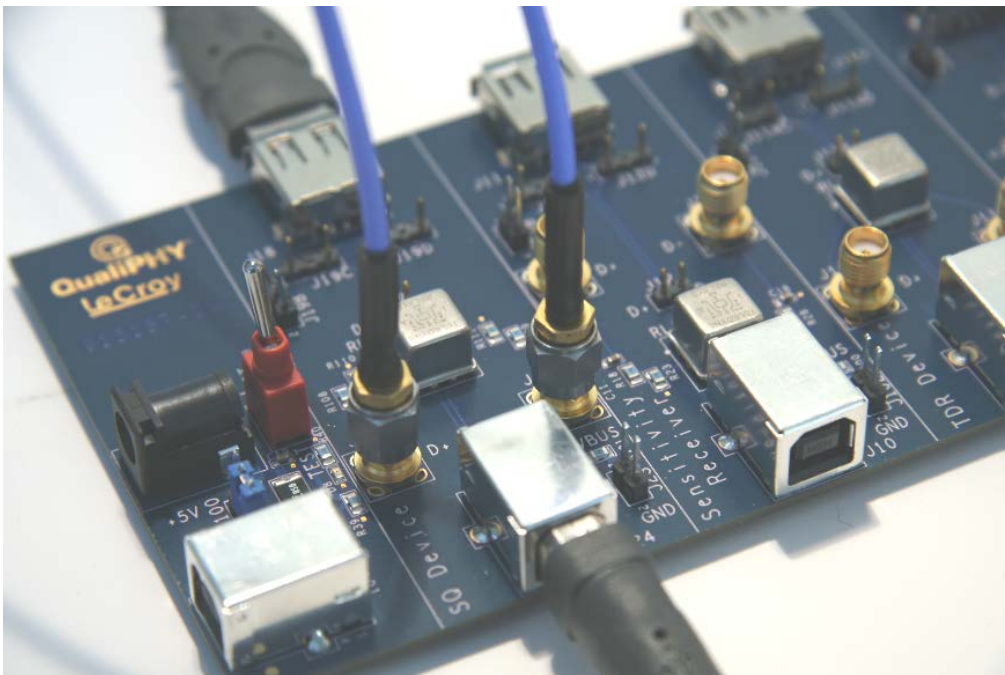

Figure 16. Two SMA Cables Connected to the Test Fixture

Some of the tests require a differential probe connected to the test fixture. The following image shows a typical differential probe hookup.

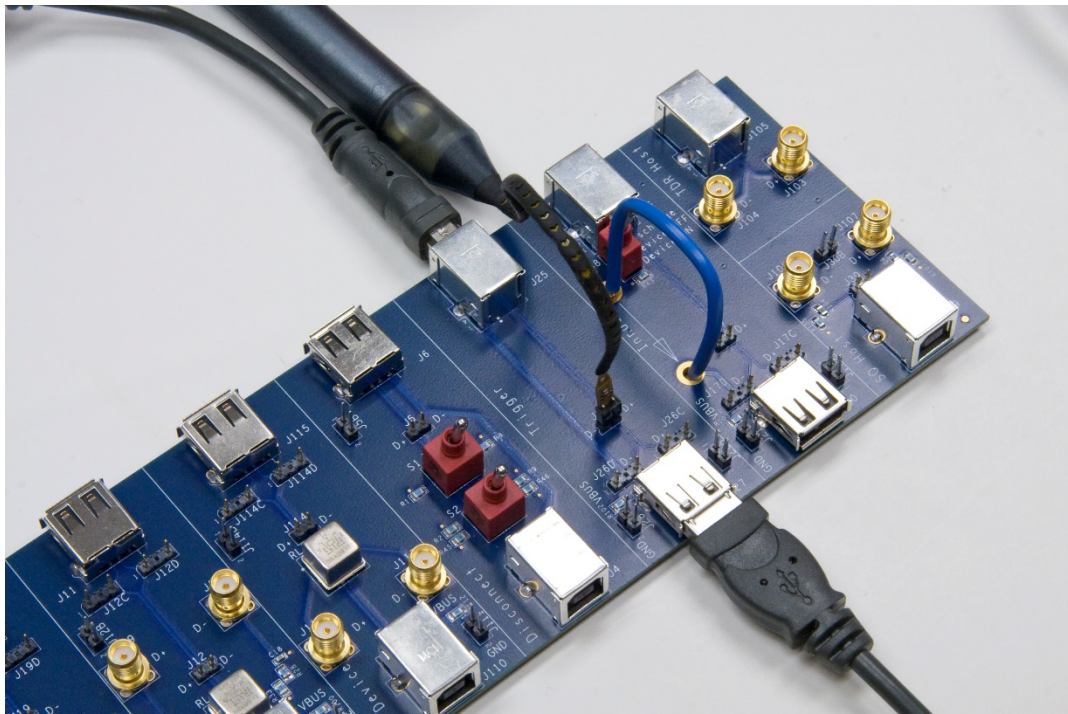

Figure 17. D600ST-SP Connected to the Test Fixture

Some of the tests require an active single-ended probe hookup. The following image shows a typical single-ended probe hookup.

Note: Make sure the lower tip socket of the probe is connected to the ground pin of the test fixture.

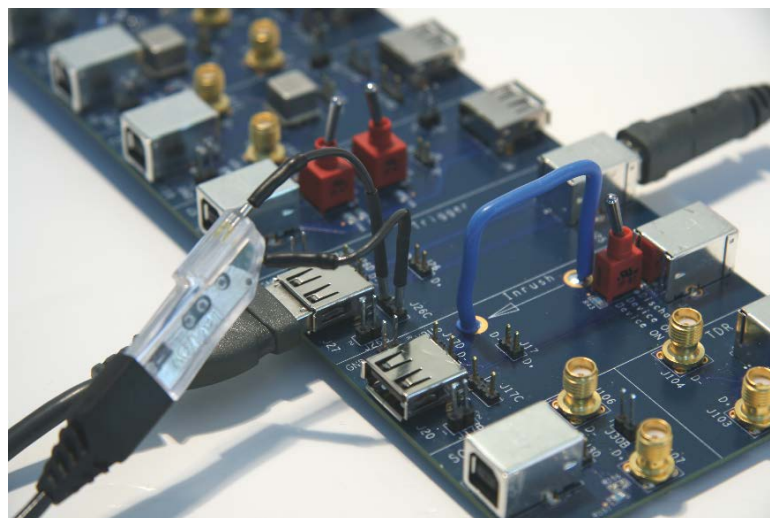

Figure 18. Single-ended Probe Connection Example

Step 3 - Sets up the HS Electrical Test Tool that generates the test signal:

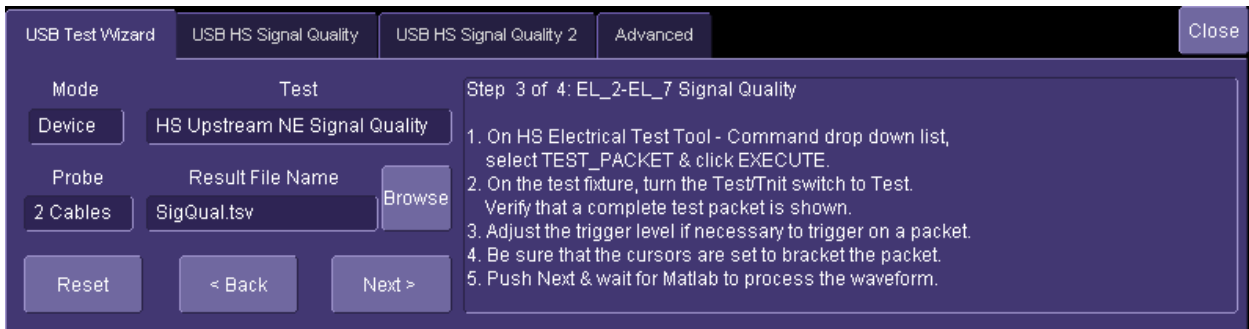

Figure 19. Step 3 of 4: EL_2-EL_7 Signal Quality

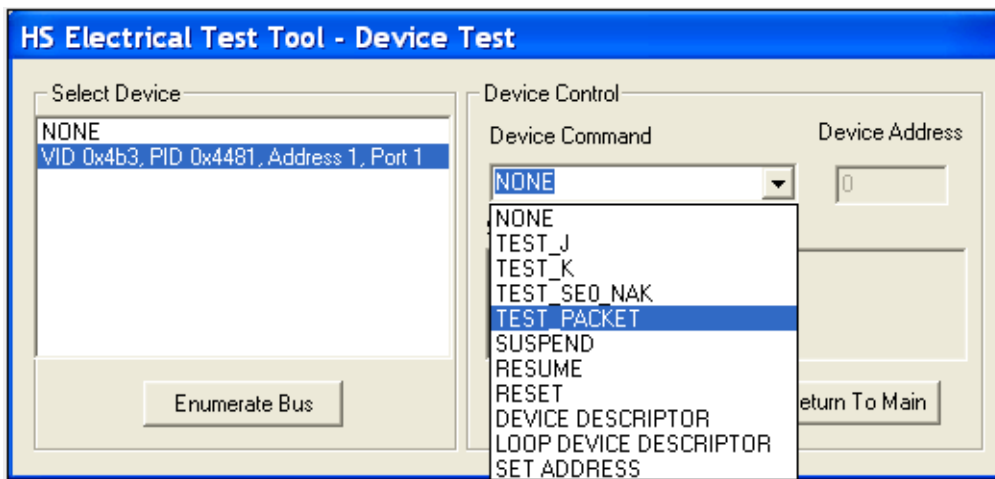

Figure 20. HS Electrical Test Tool Setup for Device High-Speed Signal Quality

High-Speed Tests

Host and Hub Downstream High-Speed Signal Quality

1. Select **Host** or **Hub** in the **Mode** control and **HS Downstream Signal Quality** in the **Test** control of the USB Test Wizard.
2. Follow the instructions on the right side of the menu. The port under test is connected to the **SQ Host** section of the Test Fixture shown as follows.
3. The SMA cables are attached to the SMA connectors in this section of the fixture.

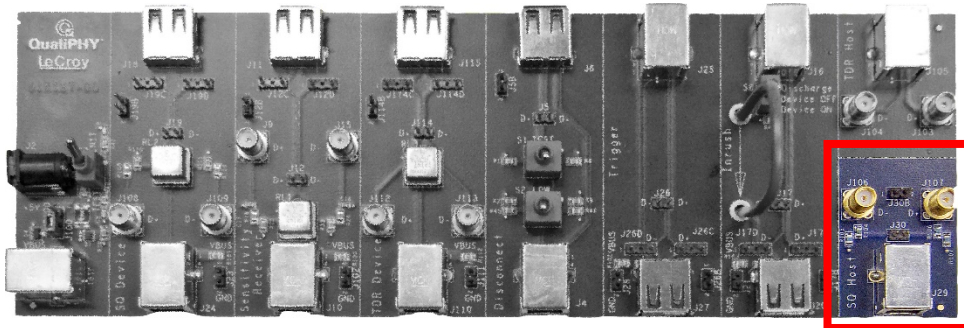

Figure 21. Signal Quality Host Section

The captured waveform should appear as follows. Cursors (dashed vertical lines in the image) must be placed on either side of the packet as shown. Use the **Cursors** knobs on the oscilloscope's front panel to adjust the position of the cursors if necessary. The waveform between the cursors is processed by the USB-IF signal quality test script to obtain an eye pattern and jitter measurements.

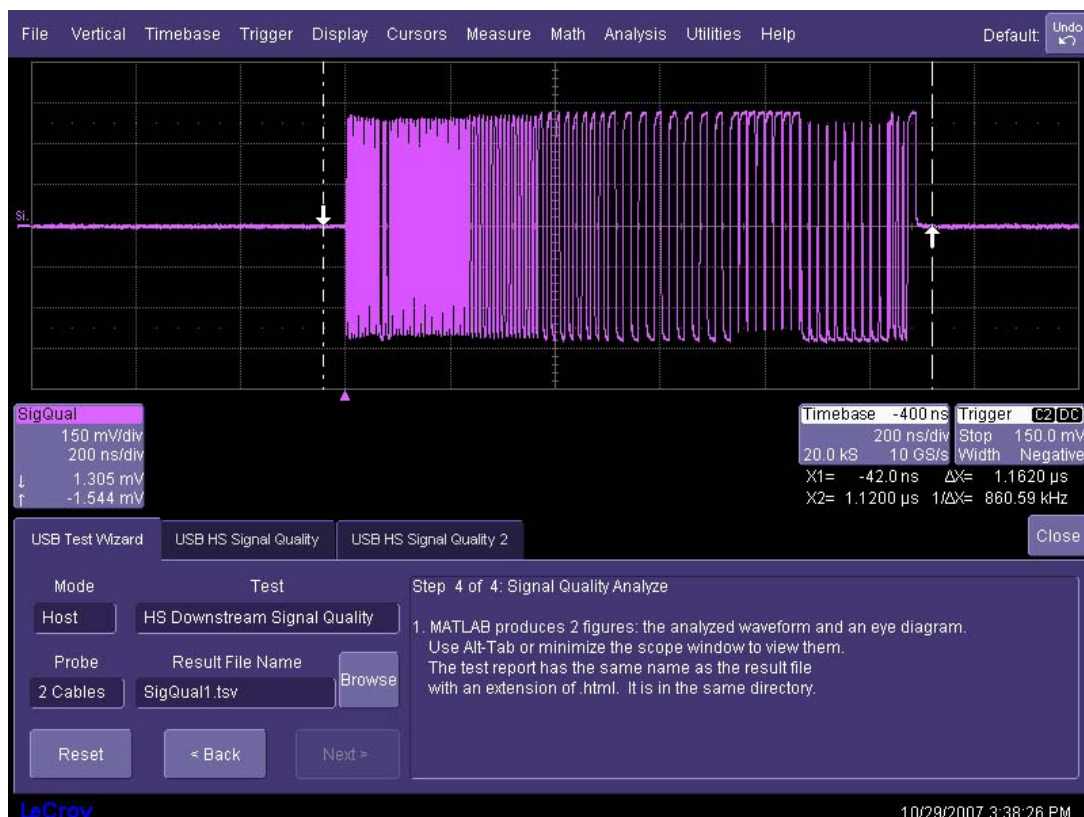

Figure 22. Host High-Speed Downstream Signal Quality Analysis

Device and Hub Upstream High-Speed Signal Quality

Select the appropriate mode (device or hub) and test (HS Upstream Signal Quality) in the USB test wizard. The device or hub upstream port is connected to the host computer through the SQ Device section of the Test Fixture.

Note: Select Device HS Upstream NE Signal Quality for a device *without* a captive cable. Select Device HS Upstream FE Signal Quality for a device *with* a captive cable.

The captured waveform should appear as follows (shown for the device test). Cursors (dashed vertical lines in the image) must appear on either side of the packet, as shown. Use the **Cursors** knobs on the oscilloscope's front panel to adjust the position of the cursors (if necessary). The waveform between the cursors is processed by the USB-IF signal quality test script to obtain an eye pattern and jitter measurements.

Note: After the device or hub upstream signal quality test is completed, the power to the device or hub must be cycled in order to stop the transmission of the test packets. The device or hub does not respond to further test commands until the power is cycled. Cycle the power by unplugging and re-plugging the USB connector and the power cord for a self-powered device or hub.

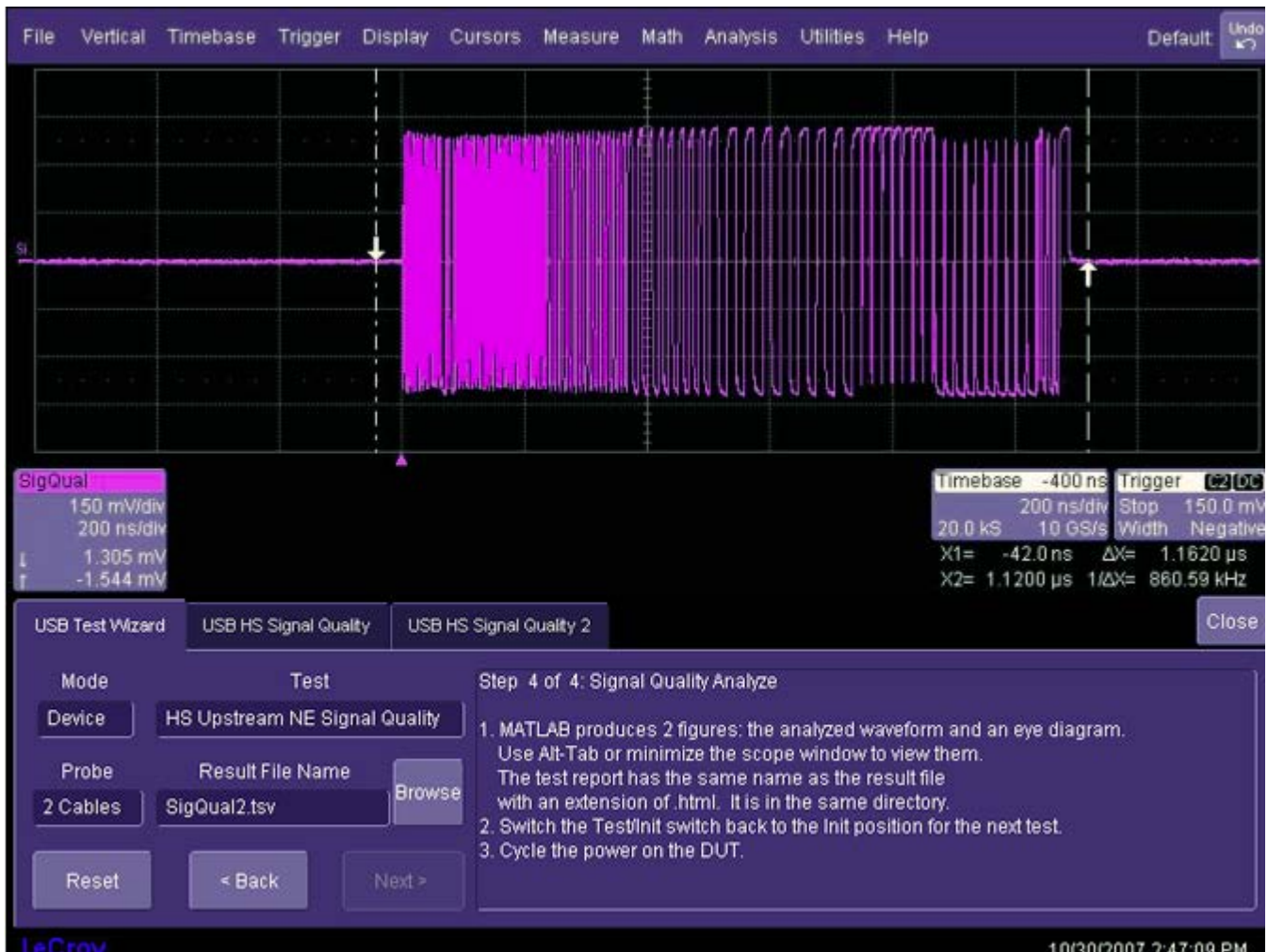

Figure 23. Device High-Speed Upstream Signal Quality

High-Speed Packet Parameters

Packet parameters represent timing measurements of the communications between host, hub, and device. USB 2.0 transmits data in bi-directional packets. The timing of these packets is critical for proper communication. The sync field at the start of the packet, the width of the EOP (end of packet), and the inter-packet timing is measured in this test.

Select **Host**, **Hub**, or **Device** in the **Mode** control and **HS Packet Param** in the **Test** control of the USB Test Wizard.

Follow the instructions in the USB Test Wizard menu to setup the test and acquire the waveform. The captured trace should look like the following image. The waveform in the center of the upper display contains three packets. The test measures the sync field and EOP width of the center packet, and two time intervals between the three packets.



Figure 24. Host High-Speed packet parameters trace

Note: The image shown is for a Host test, but the waveform also looks similar for Hub and Device tests.

Host High-Speed Chirp Timing

A High-Speed USB port must also be compatible with Full-Speed operation (12 Mb/s). High-Speed operation is detected using the K and J chirp sequences. Full-Speed operation uses a higher impedance load. When a HS capable host asserts a reset, an HS capable device must respond with the Chirp K to signal HS support. The Host then responds with a Chirp J/K sequence to also signal HS support. This test measures the timing and voltages of the HS handshake. The **SQ Device** section of the Test Fixture is used for chirp timing measurements.

1. Select **Host** in the **Mode** control and **HS Chirp Timing** in the **Test** control of the USB Test Wizard.
2. Follow the instructions in the wizard menu to setup the test and acquire the chirp timing waveforms. Two waveforms are acquired as follows:



Figure 25. Chirp Response Time

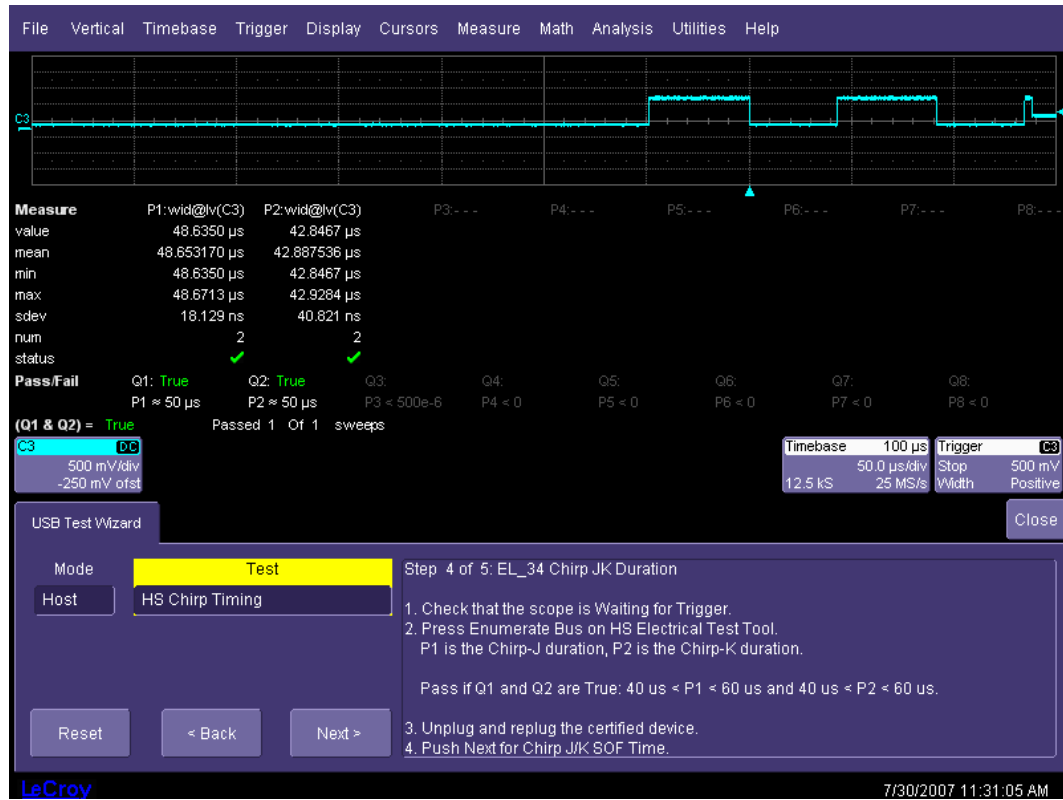

Figure 26. Chirp J and Chirp K Duration



Figure 27. Chirp to Start of Frame Time

Device and Hub High-Speed Chirp Timing

1. Select **Device** or **Hub** in the **Mode** control and **HS Chirp Timing** in the **Test** control of the USB Test Wizard.
2. Follow the instructions in the wizard menu to acquire the chirp timing waveform. The chirp waveform should look like the following image:

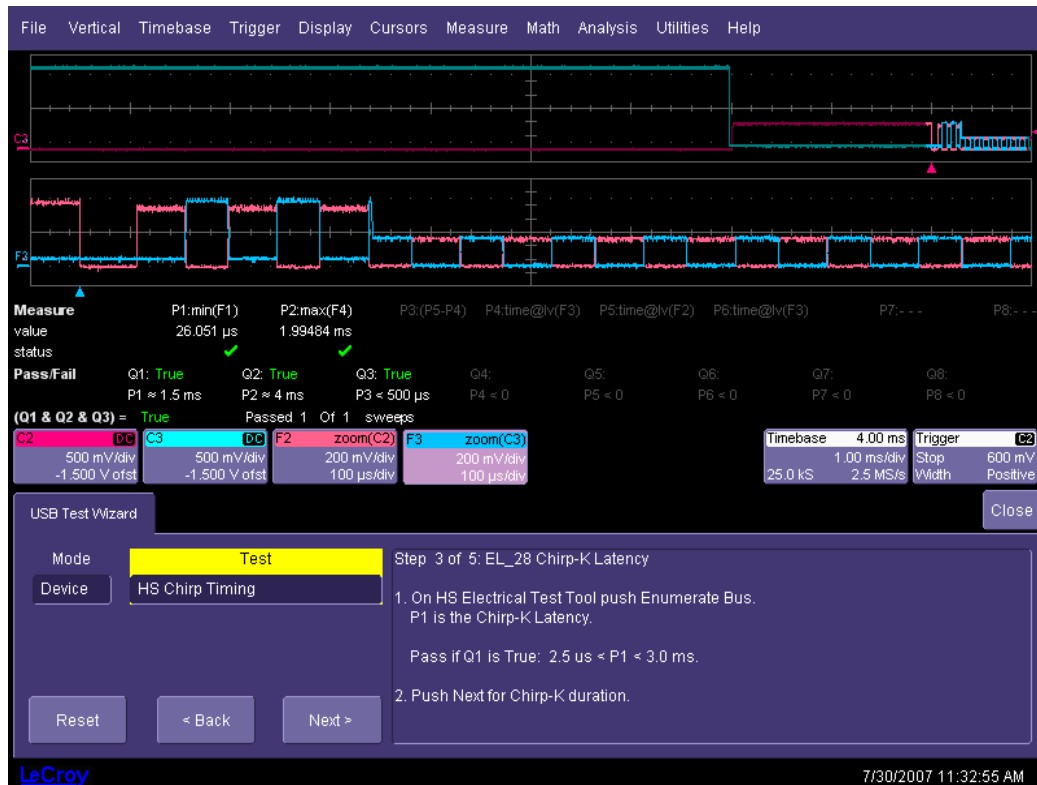

Figure 28. Chirp K Latency

Host High-Speed Suspend Resume Reset Timing

1. Select **Host** in the **Mode** control and **HS Suspend Resume Reset** in the USB Test Wizard.
2. Follow the instructions on the screen to acquire the suspend and reset timing waveforms as follows:



Figure 29. Time from Last Start of Frame to Host Suspend

Device or Hub High-Speed Suspend Resume Reset Timing

The Suspend Resume Reset test measures the timing of the Suspend Resume and Reset actions as well as the operating voltage of the device. The voltage upon resuming high-speed operation should be between 360 mV and 440 mV. The voltage measurement is intended to verify entering High-Speed mode. The test conditions are not optimal for measuring the resume voltage, and therefore it is possible for a compliant device to have a peak-to-peak voltage slightly outside this range.

1. Select **Device** or **Hub** in the **Mode** control and **HS Suspend Resume Reset** in the **Test** control of the USB Test Wizard.
2. Follow the instructions in the USB Test Wizard to acquire traces for suspend, resume, reset, and reset from suspend functions. The traces should look like the following:



Figure 30. Time from Last Start of Frame to Device Suspend

Host and Hub Disconnect

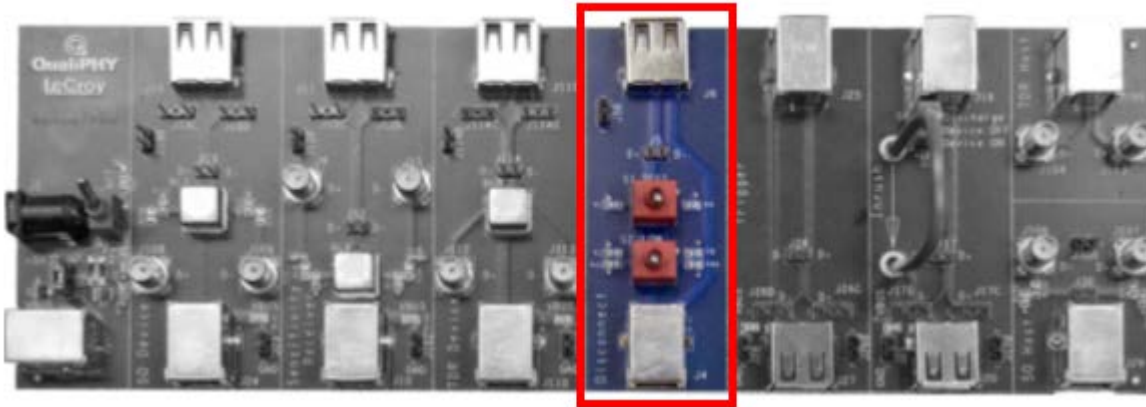

Figure 31. Host Disconnect Section of Test Fixture

1. Select **Host** or **Hub** in the **Mode** control and **HS Disconnect** in the **Test** control of the USB Test Wizard.
2. Follow the instructions in the USB Test Wizard to acquire and measure the disconnect voltages. The **Disconnect Detected** message is read from the USB-IF HS Electrical Test Tool dialog box. The traces for normal and disconnect appears as follows:

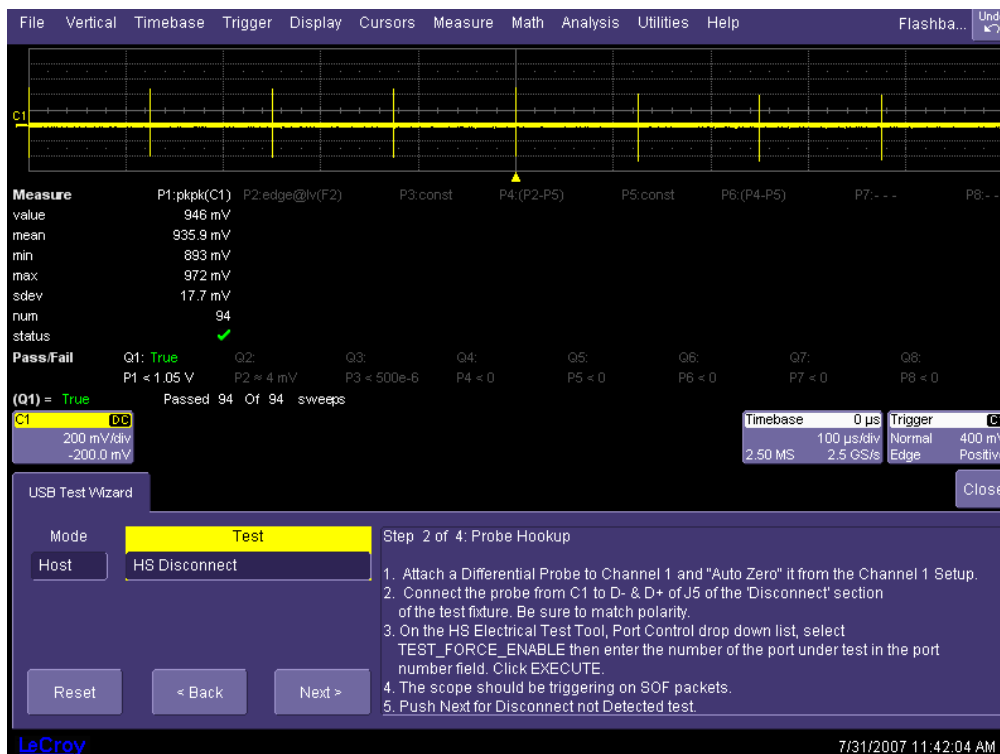

Figure 32. Initial voltage before disconnect

Note: The Host trace is shown (previous). The same trace applies to Hub downstream ports.

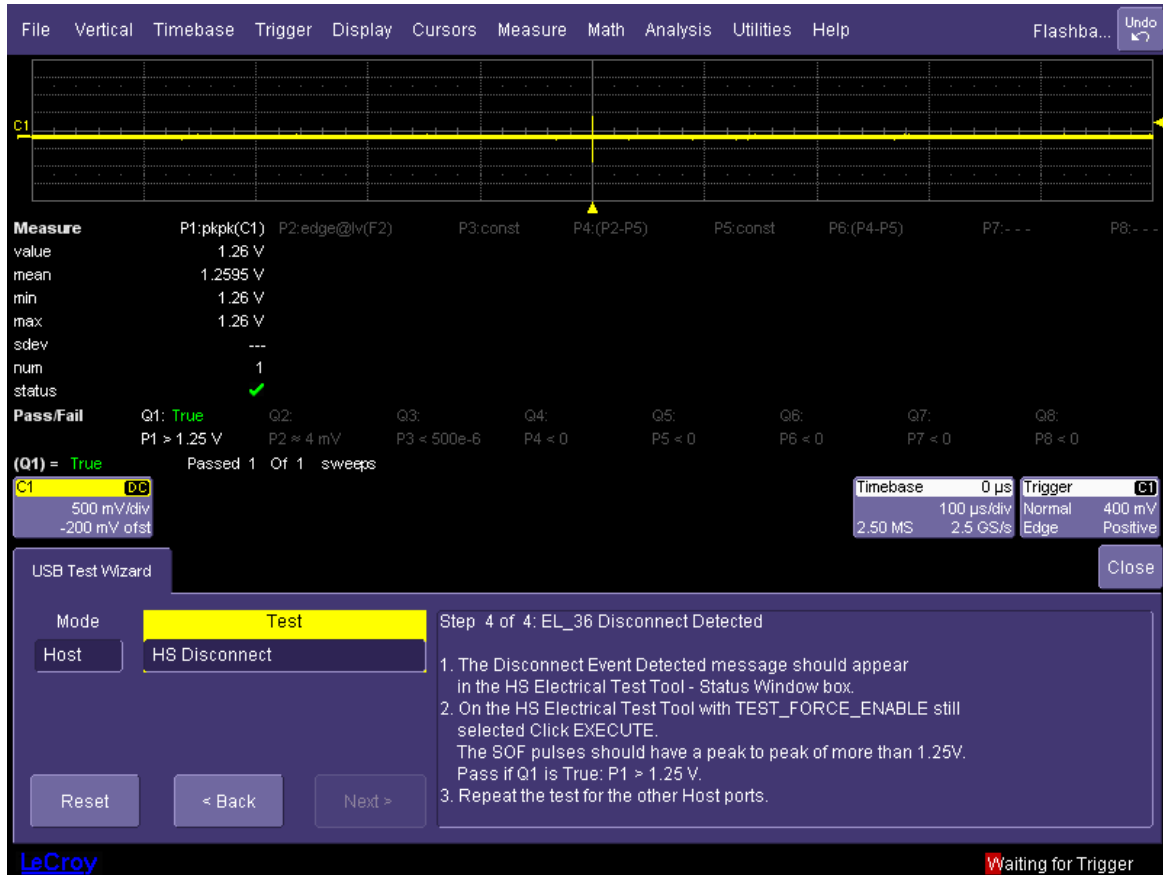

Figure 33. Voltage after disconnect

Note: The Host trace is shown (previous). Hub downstream ports may vary slightly.

Hub High-Speed Upstream Repeater

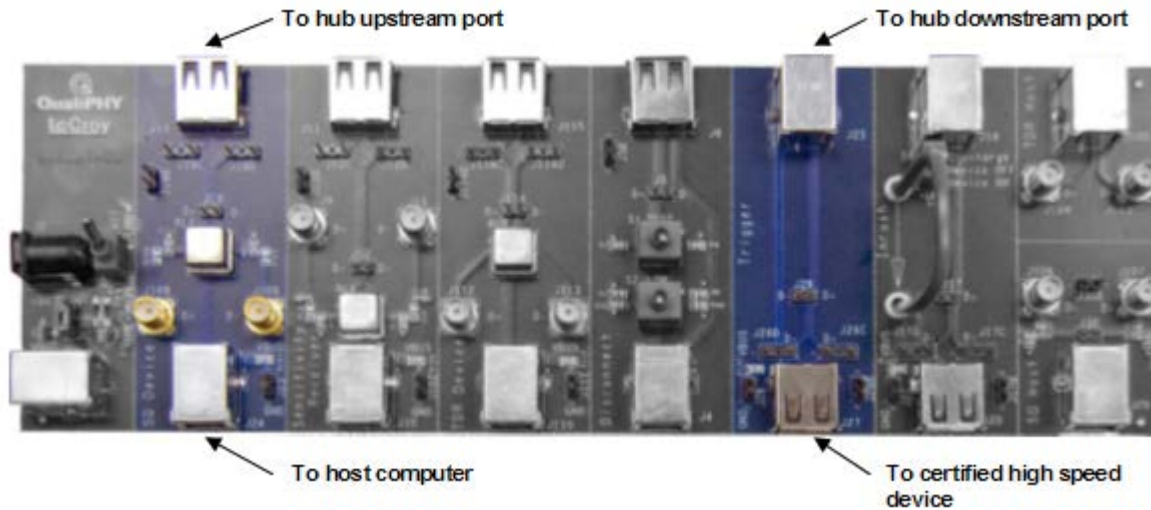

Figure 34. Hub and Device Fixture Connections for Upstream Repeater Test

1. Select **Hub** in the **Mode** control and **HS Upstream Repeater** in the **Test** control of the USB Test Wizard.

Note: Longer cables and/or adapters may be used to ease connection of Mini-B and Micro-B connectors.

2. Follow the instructions in the USB Test Wizard to acquire the waveforms as shown:



Figure 35. Initial signal acquisition for hub upstream repeater test

The second packet is the device signal. It passes upstream to the hub (C4) and the hub repeats it to the host (C1).

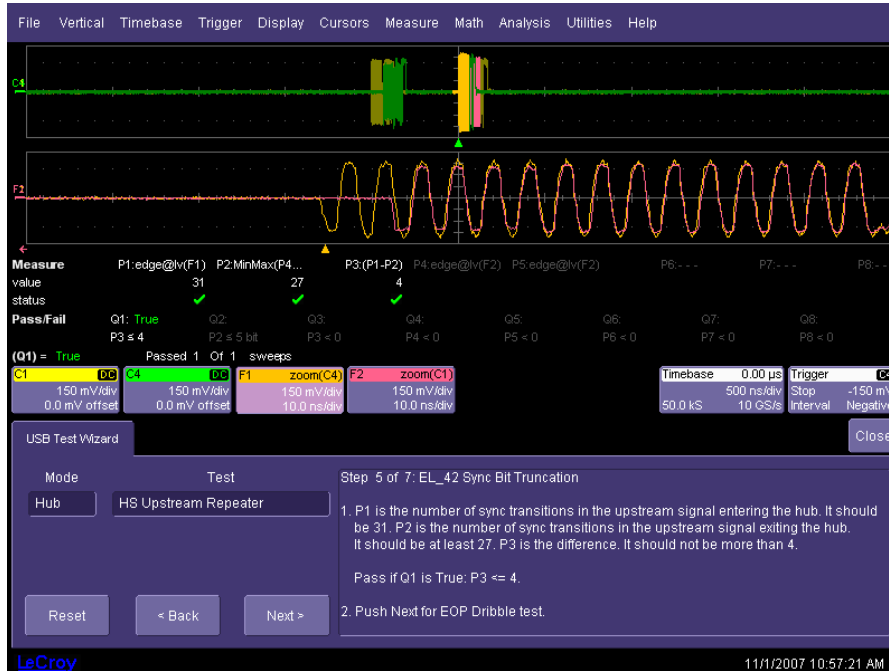

Figure 36. Hub upstream repeater sync field truncation and corruption

The two zoom traces are adjusted using the front panel Zoom controls so their end of packet pulses (the wide negative pulse on the far right) are overlaid and placed at the right edge of the display.



Figure 37. Hub upstream repeater end of packet dribble

The USB 2.0 specification allows the end of packet (EOP) field at the output of a hub to be up to 4 bits shorter than the input.



Figure 38. Hub upstream repeater delay

The measured time delay between input and output sync fields should be less than 36 bits plus 4 ns (< 79 ns). The 4 ns are added to account for the delay through the fixture.

Hub High-Speed Downstream Repeater

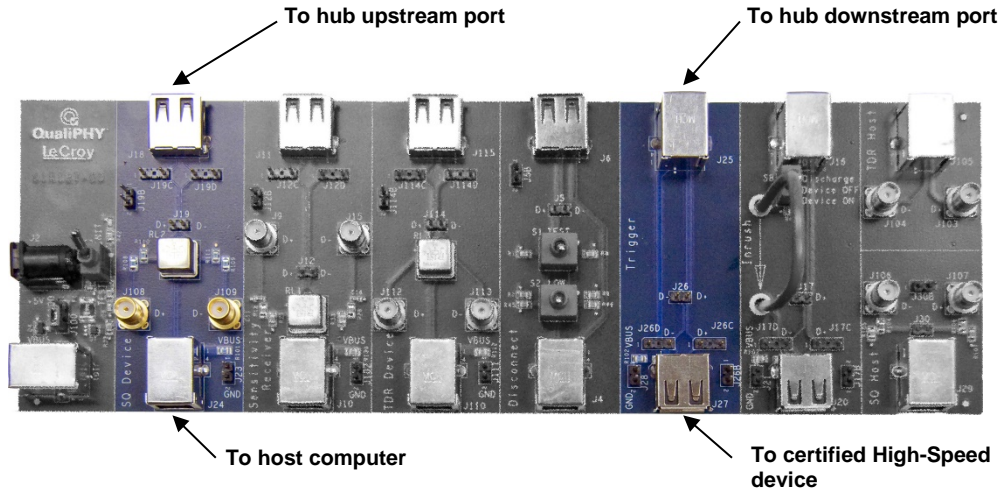

Figure 39. Hub and Device Fixture Connections for Downstream Repeater Test

1. Select **Hub** in the **Mode** control and **HS Downstream Repeater** in the **Test** control in the USB Test Wizard.

Note: Longer cables and/or adapters may be used to ease connection of Mini-B and Micro-B connectors.

2. Follow the instructions in the USB Test Wizard to acquire the waveforms as shown:

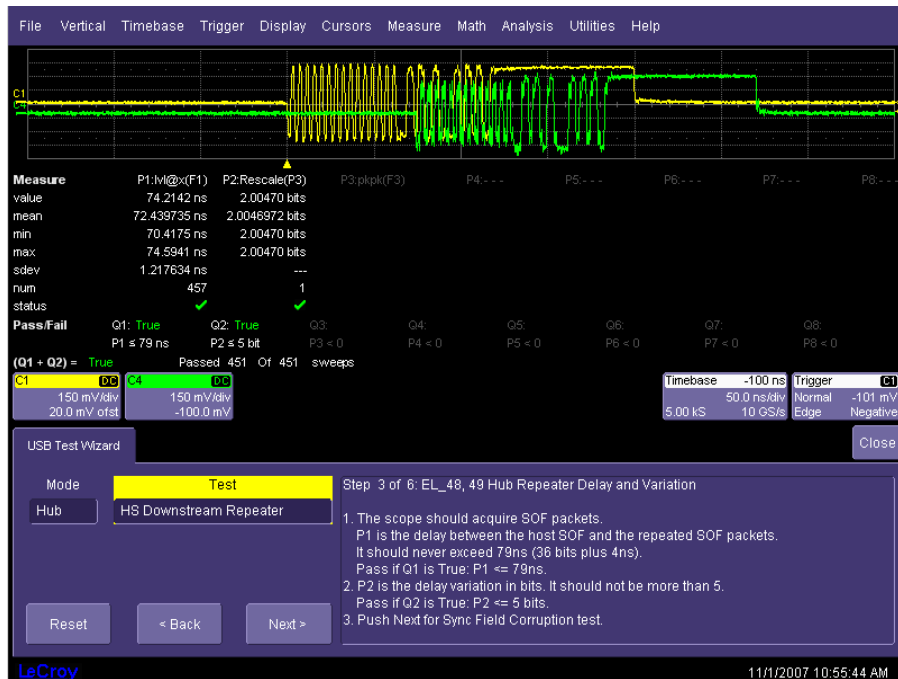

Figure 40. Hub downstream repeater delay

The measured time delay between input and output sync fields should be less than 36 bits plus 4 ns (< 79 ns). The 4 ns are added to account for the delay through the fixture.

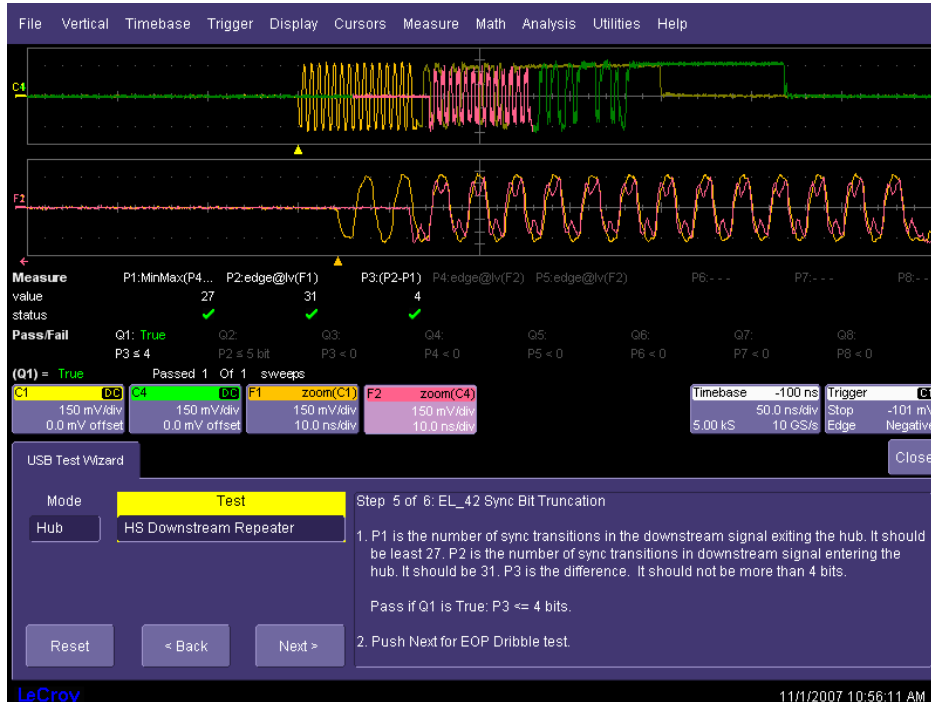

Figure 41. Hub downstream repeater sync field truncation and corruption

The USB 2.0 specification allows the synchronization field at the output of a hub to be up to 4 bits shorter than the input.

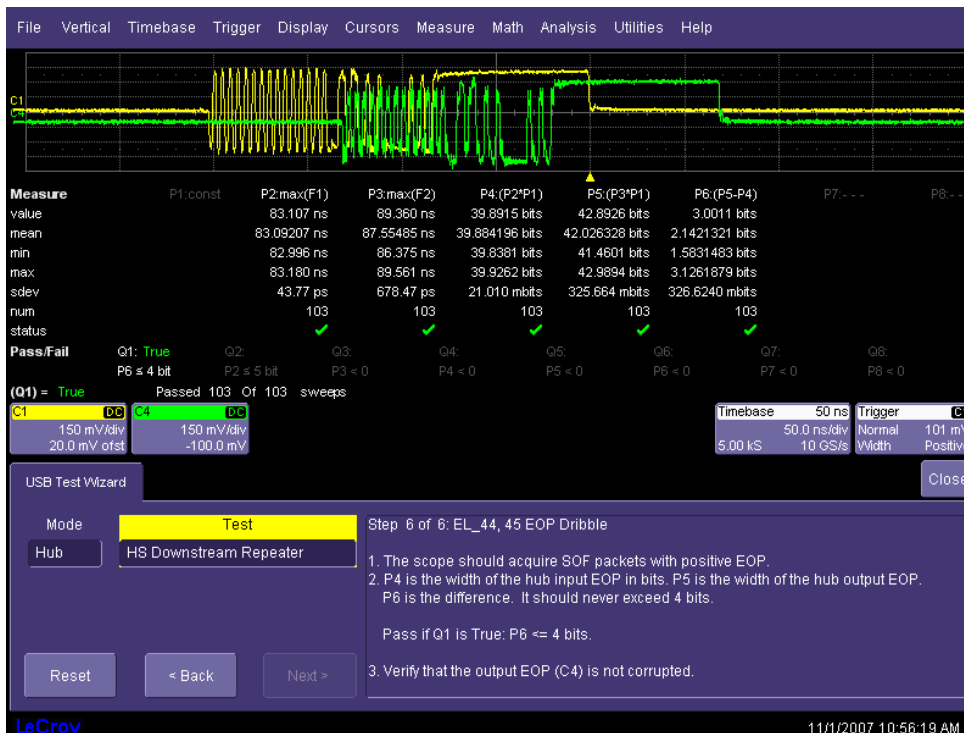

Figure 42. Hub downstream repeater end of packet dribble

The USB 2.0 specification allows the end of packet (EOP) field at the output of a hub to be up to 4 bits shorter than the input.

Receiver Sensitivity

The receiver sensitivity is measured for devices and the upstream ports of hubs. Receiver sensitivity is measured by applying a signal from a data generator to the input of the device or hub and observing the response of the device or hub. The data generator is setup to transmit IN packets to be acknowledged by the device or hub. The sensitivity is determined by reducing the level of the signal from the data generator and observing when the DUT no longer responds. The data generator can be an arbitrary waveform generator or a pattern generator. The test procedure is as follows:

1. Make sure the TEST/INIT switch on the Test Fixture is in the INIT position. Connect the “B” socket (J10) of the “Sensitivity Receiver” section of the fixture to a High-Speed port on the Test Bed Computer. Connect the “A” socket (J11) of the “Sensitivity Receiver” section of the Test Fixture to the device under test.
2. Start the USB-IF HS Electrical Test Tool, select **Device** and then click **Test**. Click the **Enumerate Bus** button once to force enumeration of the newly connected device. The device under test should be enumerated with the device’s VID shown.
3. Load the “MIN_ADD1” waveform into the generator (see Error! Reference source not found. for details on creating this waveform). This generates “IN” packets (of compliant amplitude) with a 12-bit SYNC field. Connect the generator to the “Sensitivity Receiver” section of the Test Fixture, using the supplied SMA cables. When connecting the outputs of the generator make sure to connect the first channel to the D+ SMA (J9) and the second channel to the D- SMA (J15).
4. Connect the differential probe from channel 1 of the oscilloscope to the differential probe header J12 of the “Sensitivity Receiver” section of the Test Fixture. Recall the **HSRcvrSensitivity.lss** panel file on the oscilloscope, using the **File → Recall Setup** menu. Use the **Browse** button in the “Recall Panel From File” control to select the file from the **D:\Applications\USB2\Setups** directory. Press the **Recall Now** button to select this setup file.

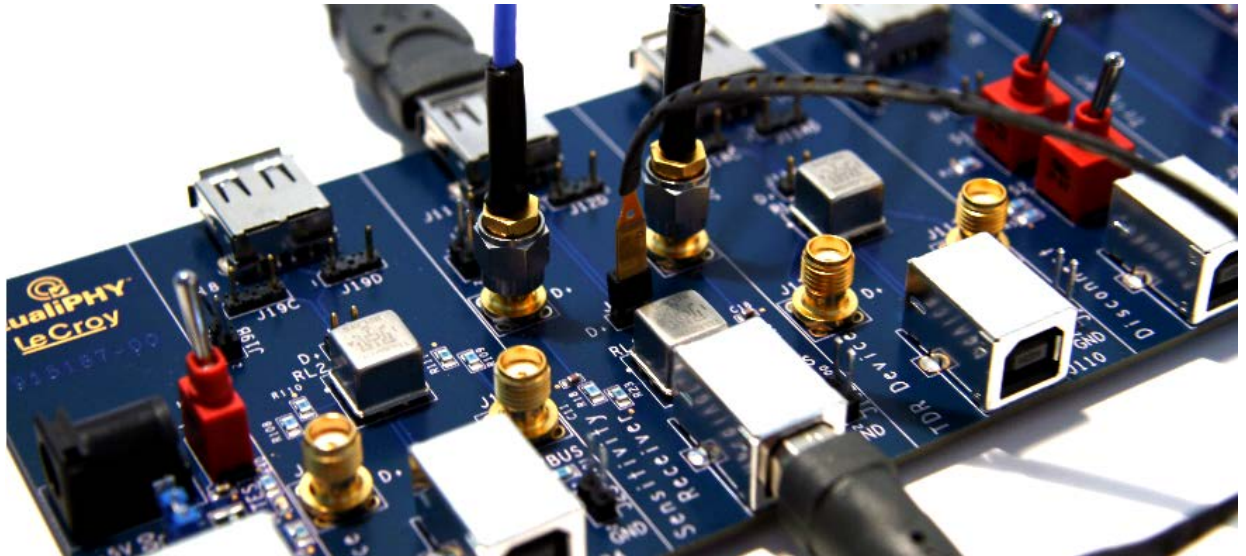

Figure 43. Receiver Sensitivity Test Setup

- From the HS Electrical Test Tool - Device Command menu, select **TEST_SE0_NAK** from the Device Command drop down menu. Click **EXECUTE** once to place the device into TEST_SE0_NAK test mode.

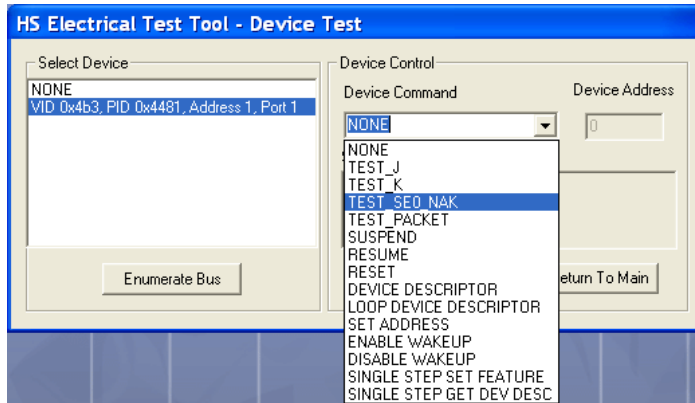

Figure 44. Use Device Command drop down list of HS Electrical Test Tool

- Place the TEST/INIT on the Test Fixture to the TEST position. This switches in the data generator in place of the host controller. The data generator emulates the “IN” packets from the host controller.
- Verify that there is a response packet (NAK) for all packets sent from the data generator. This should appear as a sequence of two packets with a small gap between them followed by a larger gap as shown in the figure below. The first packet is the data generator output and the second packet is the NAK from the device or hub under test. If there is a response for every packet sent by the generator than the device or hub passes EL_18.

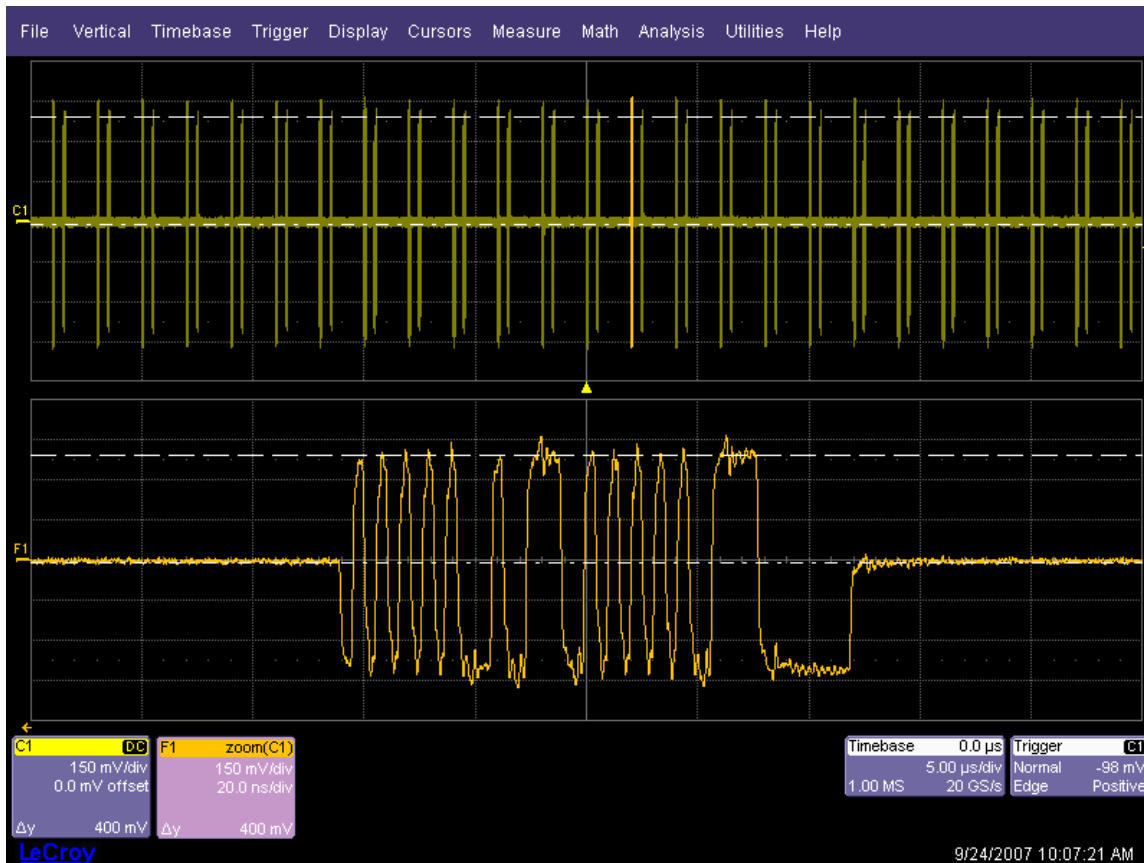

Figure 45. Response to IN tokens with 12-bit sync - all packets NAK'd

8. Now load the "IN_ADD1" waveform into the generator (see Appendix A for details). The generator amplitude should be set to the 400 mV. This generates IN tokens with a full 32 bit sync and nominal amplitude.
9. Verify that there is a response packet (NAK) for all packets sent from the data generator, as in step 7.
10. Reduce the amplitude of the data generator packets in small steps while monitoring the response from the device on the oscilloscope. The adjustment should be made to both generator outputs such that the level is set to the same value for both outputs. Reduce the amplitude until the NAK response packet begins to become intermittent, as shown in the figure below. At this point, increase the amplitude such that the NAK packet is not intermittent. This is just above the minimum receiver sensitivity levels before squelch.

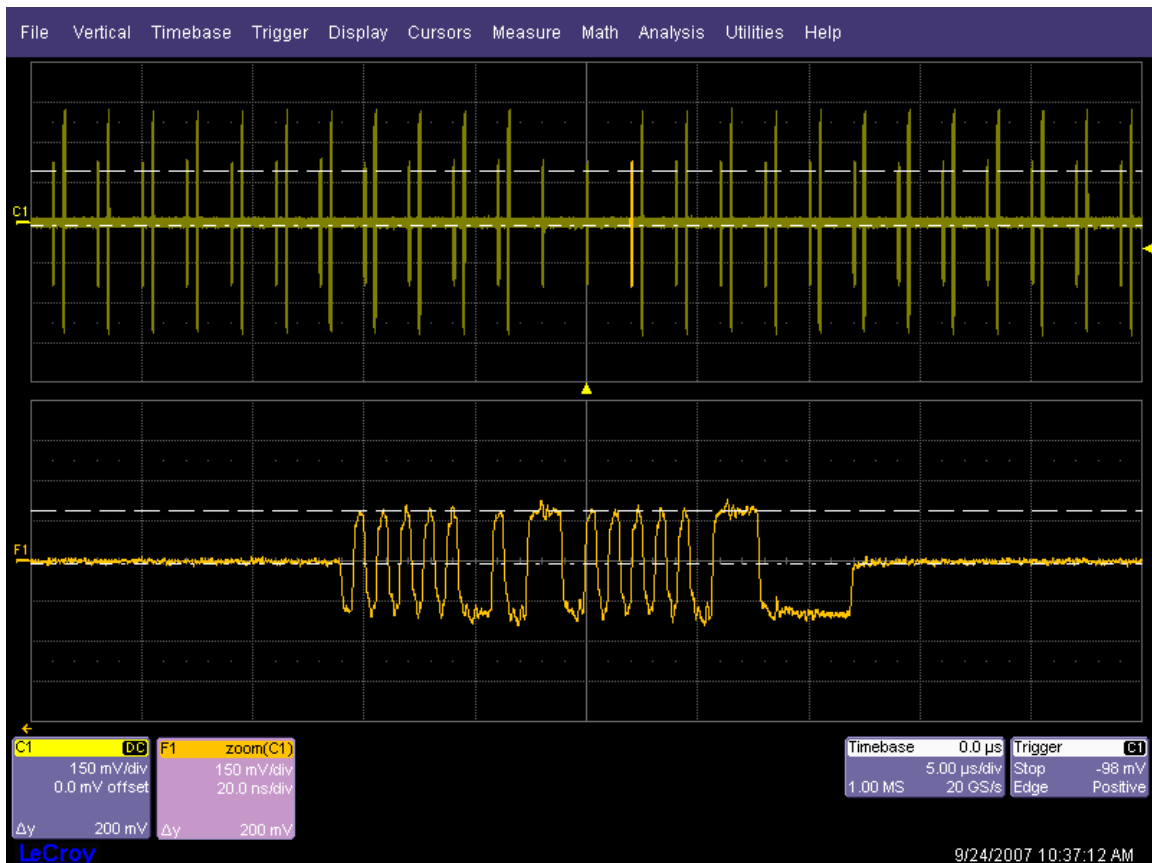

Figure 46. Intermittent Response to IN tokens at low amplitude

11. Measure the zero-to-positive peak of the packet from the data generator using the cursors in the lower (zoom) window of the oscilloscope display. Use the upper cursor position knob to position cursor 1 on the zero level of the waveform and the lower cursor control knob to position cursor 2 on the positive peak of the waveform. The cursor should be positioned on the plateaus of the wider pulses to avoid inflating the reading due to overshoots. The difference voltage is indicated in the F1 waveform box, "zoom(C1)", at the lower left corner of the oscilloscope screen. Record this value as EL_17 positive threshold.
12. Move cursor 2 to the negative peak of the waveform in the lower window of the oscilloscope screen, using the lower cursor control knob again, and position the cursor on the wider plateaus to avoid overshoots. Read the difference voltage in the waveform information box at the bottom left of the oscilloscope display. Record this value as EL_17 negative threshold. The receiver must continue to NAK packets above +/- 150 mV to pass EL_17.
13. Now further reduce the amplitude of the packet from the data generator in small steps, still maintaining balance between the outputs until the receiver just ceases to respond with NAK. This is the squelch level of the receiver.

14. Measure the Zero-to-Positive Peak and Negative Peak of the packet from the data generator, using the method described in steps 11 and 12. As long as the receiver ceases to NAK the data generator packet below +/- 100 mV, it is considered to have passed EL_16.

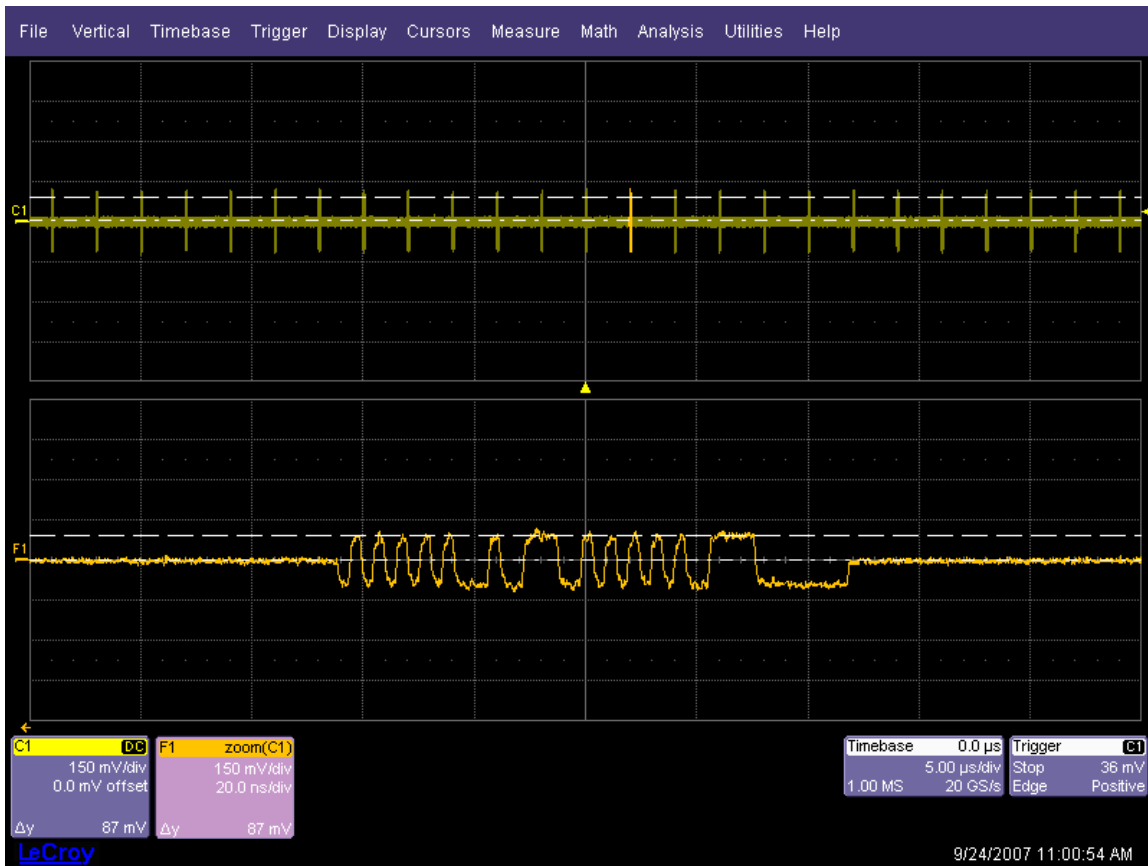

Figure 47. Receiver squelch level – no response to IN tokens

Note: With certain devices, making an accurate zero-to-peak measurement of the IN packet from the data generator may be difficult due to excessive reflection artifacts. Also, on devices with captive cable, the measured zero-to-peak amplitudes of the IN packet at the test fixture could be considerably higher than that seen by the device receiver. In these situations, it is advisable to make the measurement near the device receiver pins on the PCB.

Full and Low-Speed Tests

All HS-capable devices, hosts, and hubs must support Full-Speed (12 Mb/s) data rates. Compliance testing requires this rate be tested along with the High-Speed (480 Mb/s) rate. Full-Speed compliance requires both interoperability and electrical tests. The Teledyne LeCroy USB 2.0 test solution addresses the electrical test requirements for Full-Speed operation. These tests include signal quality, inrush current, and droop/drop. The package also supports Low-Speed electrical tests, which apply only to hub/host downstream ports and Low-Speed devices. The following topics provide detailed descriptions of the Full and Low-Speed electrical tests for hosts, hubs and devices.

Required Equipment

Please refer to the *USB-IF Full and Low-Speed Electrical and Interoperability Compliance Test Procedure* available at www.usb.org for a current list of standard USB products recommended for use in FS/LS electrical testing and interoperability testing. Due to limited product lifetimes the approved products for testing change periodically so it is important to obtain the latest equipment lists periodically.

The following list of standard equipment is required for performing Full and Low-Speed electrical tests:

	Item	Quantity
1	100 mA load board (for bus powered hubs only)	1*
2	500 mA load board	1*
3	Droop test board	1
4	SQiDD board	1
5	Full-Speed hub (self powered)	1
6	High-Speed hub (self powered)	4
7	5 m USB cables	6

* Additional load boards may be required depending on the number of downstream ports on the product. The test fixture provides enough loads to test 12 port hubs/hosts.

The first 4 items in the previous list are contained within the Teledyne LeCroy Test Fixtures. The following figure shows the sections of the fixtures used for these tests.

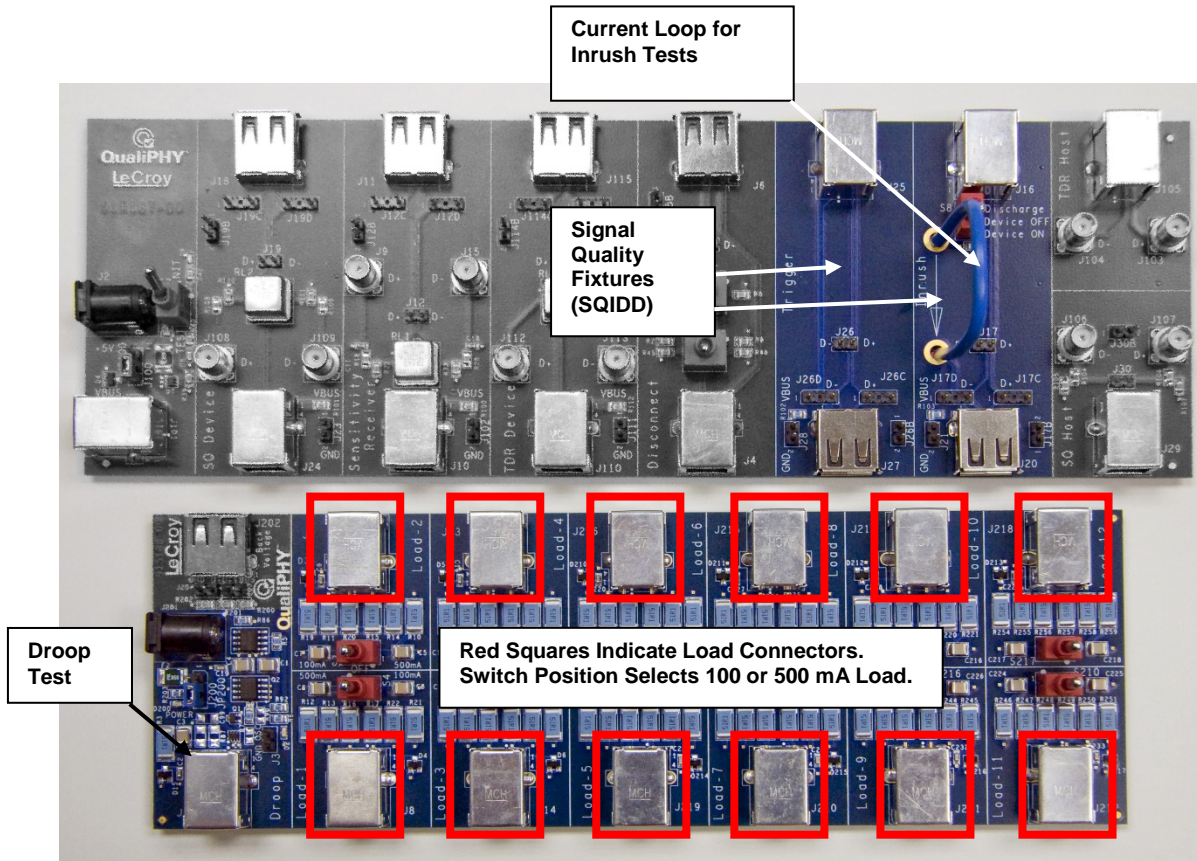

Figure 48. FS/LS Signal Quality Test Fixture Sections

Hub and Host Drop Test

Note: The drop test is performed using a voltmeter and the test fixture alone. The oscilloscope is not used for this test. The drop test is **not** contained in the USB Test Wizard.

Set up the voltmeter to measure the voltage drop across the loads, as shown in the following figure. Attach all the output ports of the hub or host to any of the loads on the Test Fixture. Make sure the three position switches on each load are in the center (off) position before connecting the cables.

Note: The Upstream Port VBus voltage measurement (J23) is only required when testing Bus-powered Hubs.

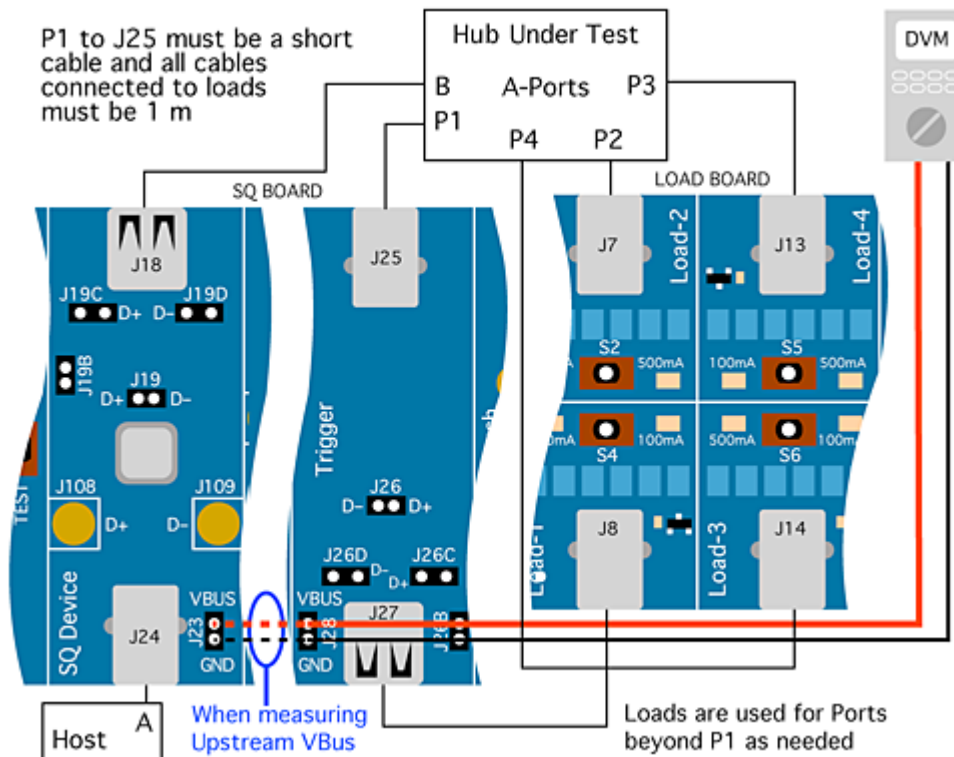

Figure 49. Bus-Powered Hub Drop test equipment setup

Self-Powered Hubs or Hosts

1. Switch the loads to the 500 mA position one at a time and verify that the voltage is between 4.75 and 5.25 V.
2. Repeat as necessary for all ports of the hub or host.

$$V_{\text{DROP}} = V_{\text{NL}} - V_{\text{LOADED}}$$

Where

$$V_{\text{NL}} = V_{\text{BUS}} \text{ at a downstream USB connector with USB ports open circuited (no load)}$$

And

$$V_{\text{LOADED}} = V_{\text{BUS}} \text{ at a downstream USB connector with 100 or 500 mA loads, as appropriate, on all USB ports}$$

Bus-Powered Hubs

1. Switch the loads to the 100 mA position one at a time and verify that the voltage is above 4.4 V.
2. Repeat as necessary for all ports of the hub.

$$V_{\text{DROP}} = V_{\text{UPSTREAM}} - V_{\text{DOWNSTREAM}}$$

Where

$$V_{\text{UPSTREAM}} = V_{\text{BUS}} \text{ at a hub's upstream connection}$$

And

$$V_{\text{DOWNSTREAM}} = V_{\text{BUS}} \text{ at one of the hub's downstream ports}$$

Test Criteria

Section 7.2.2 of the USB 2.0 specification requires self-powered downstream USB ports to provide a V_{BUS} between 4.75 and 5.25 V while bus-powered hubs must maintain V_{BUS} at 4.40 V or greater. Drop testing evaluates V_{BUS} under both no-load and full-load (100 or 500 mA, as appropriate) conditions. Self-powered hubs, systems, and laptops must provide a voltage between 4.75 and 5.25 V under all load conditions. Bus-powered hubs must have a $V_{\text{DROP}} \leq 100$ mV between their upstream and downstream ports when 100 mA loads are present on all downstream ports. This ensures they supply 4.4 V to a downstream device, given a 4.75 V upstream supply, minus 100 mV drop through the hub and 250 mV drop through the upstream cable. If the hub does not use a captive cable (the USB cable has a B plug), the voltage drop is the difference between the measured upstream voltage level and the lowest measured downstream value. Bus-powered hubs with captive cables (the USB cable does not have a B plug) must have V_{DROP} less than or equal to 350 mV between the upstream connector and their downstream ports. This includes the drop through the cable. Special consideration should be made for laptops unable to provide compliant voltages with 500 mA loads while running on battery power, provided they can meet the required voltages with one or more of the loads reduced to 100 mA. However, the end user may experience confusion and difficulty in this situation, unless the operating system or laptop vendor provides a warning message window alerting the user that a high-power device cannot be used under battery power.

Droop Test

Equipment setup:

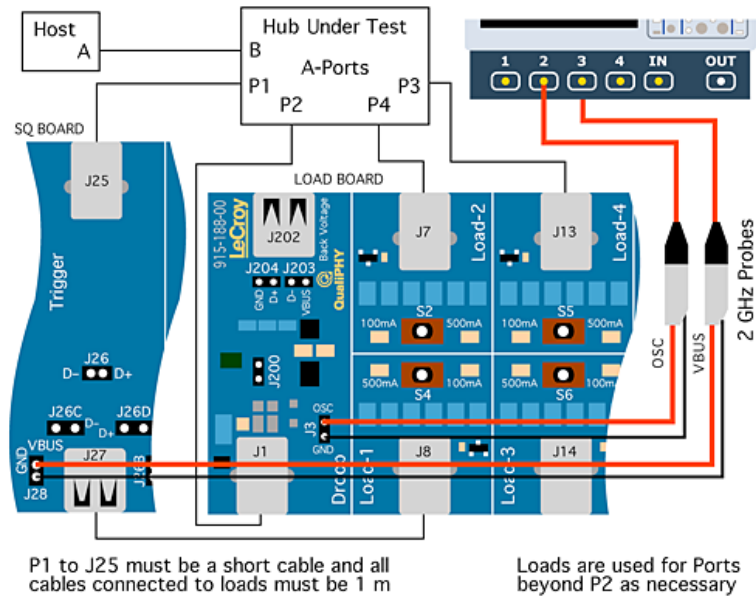

Figure 50. Hub Droop Test Equipment Setup

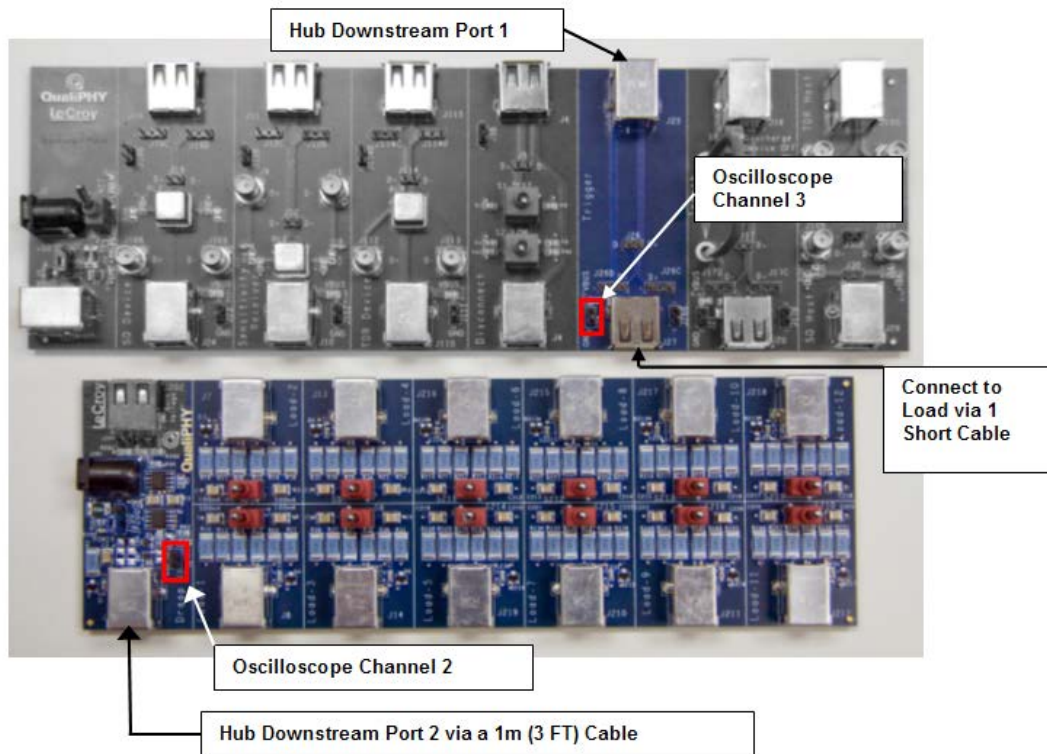

Figure 51. Device and oscilloscope connections for droop test

Remaining Loads are connected to the remaining downstream ports.

Test Steps

1. Select **Host** or **Hub** in the **Mode** control and **Droop** in the **Test** control of the USB Test Wizard. Follow the instructions in the test wizard to acquire the droop waveform as shown:

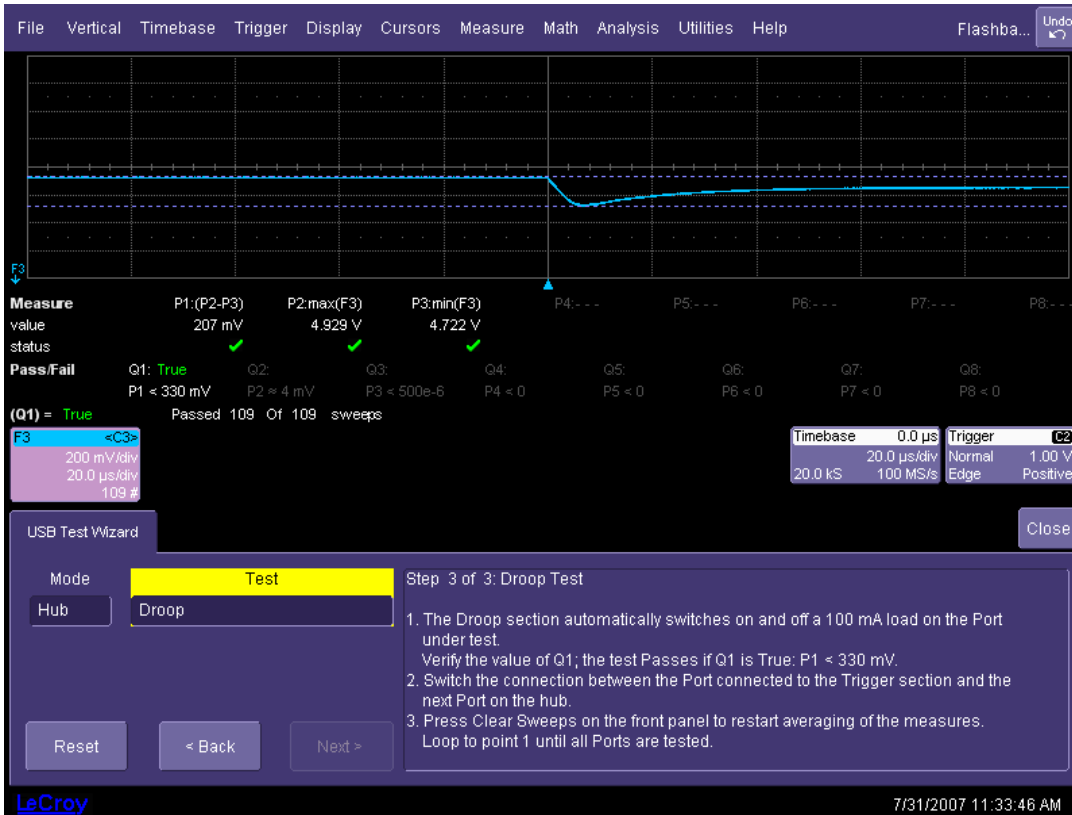

Figure 52. Droop voltage waveform

2. Connect port 1 (port under test) of the hub or host under test to the Trigger section B socket (J25) of the Test Fixture using a short cable. Connect the A socket (J27) of the Trigger section to load 1 (J8) of the fixture using a 1 meter (3 ft.) USB cable. Connect port 2 of the hub or host under test to the droop section of the Test Fixture (J1) using a 1 meter (3 ft.) USB cable. Connect the remaining ports of the hub or host under test to the any of the remaining loads of the Test Fixture using 1 meter (3 ft.) USB cables. All hub/host ports should have a load attached. Make sure all of the switches are in the center (OFF) position before connecting the cables.
3. Connect channel 2 of the oscilloscope to J3 in the droop section of the fixture. Connect channel 3 of the oscilloscope to J28 in the Trigger section of the fixture.
4. Switch all test loads to the appropriate current level (100 mA or 500 mA) as indicated in the table in the Test Results section as follows.

Test Criteria

Section 7.2.4.1 of the USB 1.1 specification allows a maximum droop of 330 mV in the V_{BUS} supplied to a USB port when a device is hot plugged into another port. Droop testing evaluates worst-case droop by applying a 100 mA load and 10 μ F of capacitance, which switches on and off to one of the adjacent available ports when all other ports are supplying the maximum load possible. All V_{BUS} measurements are relative to local ground.

Test Results

	Bus-powered Hub	Self-powered Hub/System	Laptop	
			Battery powered	Self powered
Load type	100 mA	500 mA	__100__500 mA	500 mA
V _{NL}				
V _{LOADED}				
V _{UPSTREAM}				
V _{DOWNSTREAM}				
V _{DROP}				
V _{DROOP}	Less than 330 mV			

Reporting Results

No Load Voltage: passing values are from 4.75 to 5.25 V

Loaded Voltage: passing values are from 4.75 to 5.25 V

Upstream Voltage: passing values are from 4.40 to 5.25 V

Downstream Voltage: passing values are from 4.75 to 5.25 V

Voltage Drop

Droop Voltage

Note: Please do not connect a Hub or a Host to the droop fixture longer than 5 minutes. Resistance may become unstable under high temperature. Touching the resistance area may result in scalding or burning.

Host Low-Speed Downstream Signal Quality

1. Set up the equipment as shown in the following figure.
2. Select **Host** in the **Mode** control and **LS Downstream Signal Quality** in the **Test** control of the USB Test Wizard.
3. Use the **SQ Device** section of the Test Fixture as the SQiDD in the following figure. Ensure the TEST/INIT switch is in the **INIT** position. The best method to capture and analyze Low-Speed downstream signal quality is to capture both a keep-alive (Low-Speed EOP) and a packet. The root hub is required to either generate a keep-alive or send Low-Speed traffic once per frame whenever a Low-Speed device is directly attached. Capture downstream traffic with Low-Speed devices with a trigger on the rising edge of D-.

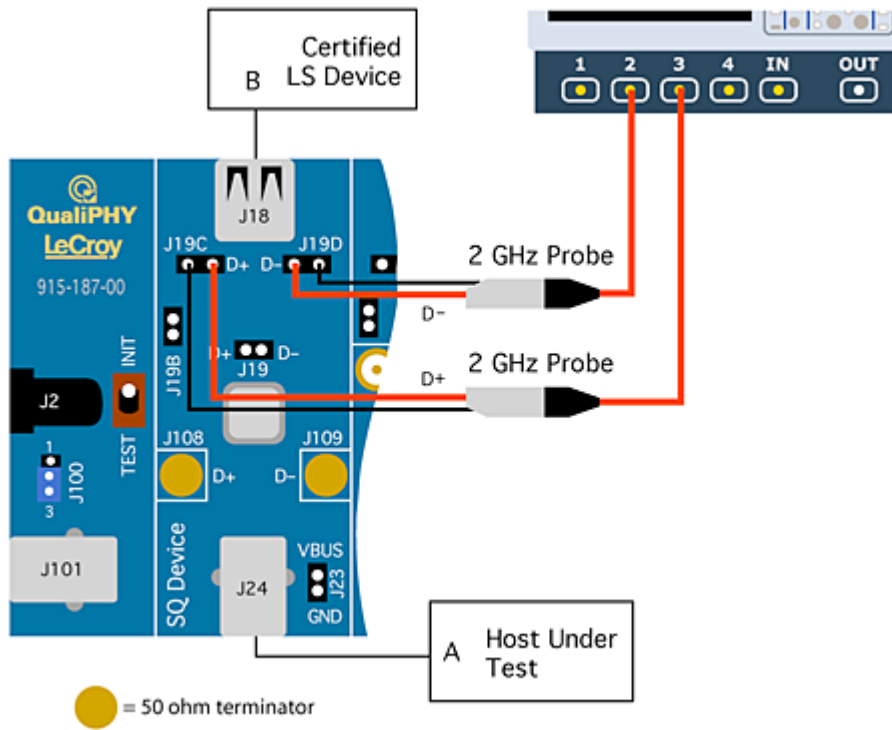

Figure 53. Host Low-Speed Downstream Signal Quality Test Equipment Setup

Note: The USB-IF High-Speed Electrical Test Tool is not used for this test and should not be running.

4. Press the Single Acquisition button on the oscilloscope until a full packet is displayed on the screen. The full packet may consist of the keep alive and a data packet, or could be just a data packet and should fill most of the oscilloscope screen. Use the cursors to select the downstream portion of the data packet (shown as follows). The cursors are set to 1 UI before the first bit in the sync field on the left and 1 UI after the end of the EOP on the right.

5. Press the **Next** button in the USB Test Wizard once the proper packet is captured. The MATLAB analysis script is executed and the signal quality eye pattern is displayed.

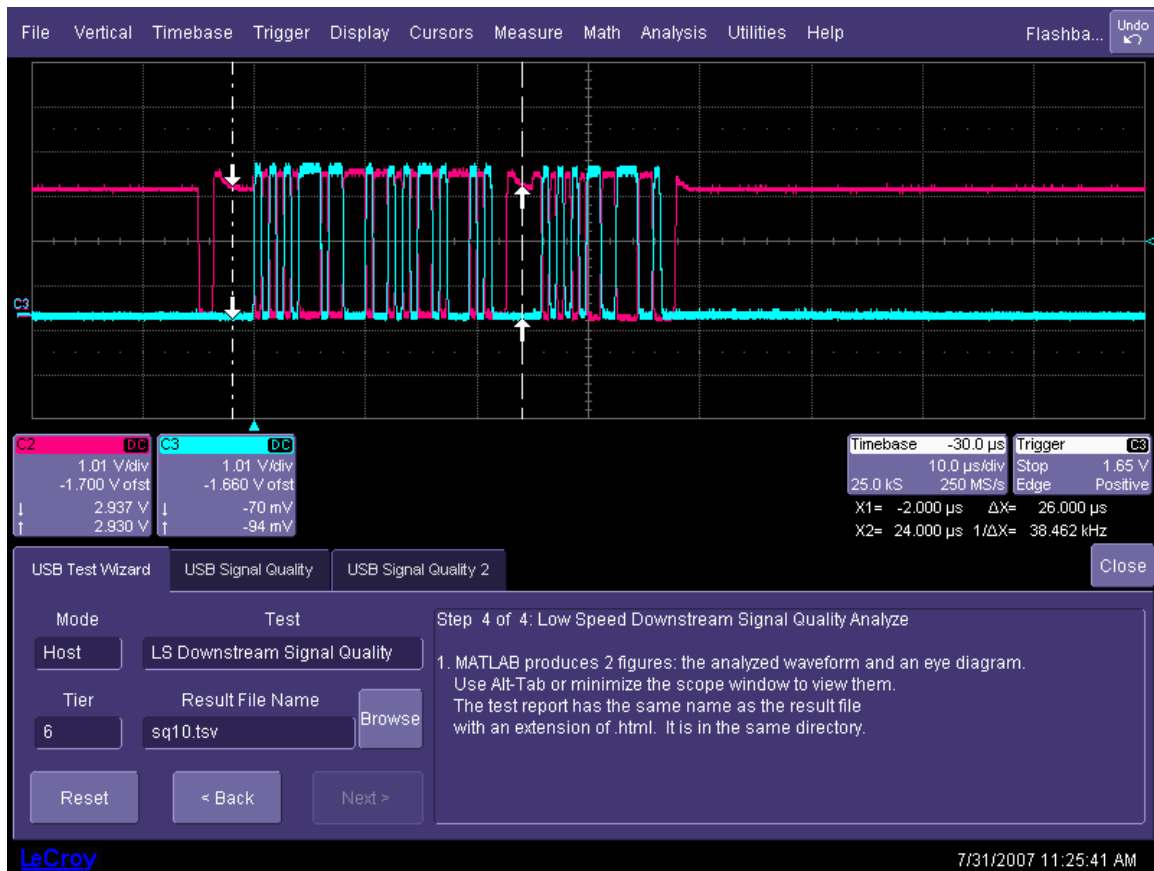

Figure 54. Cursor Positioning for Host Low-Speed Signal Quality Test

Host Full-Speed Downstream Signal Quality

1. Connect the system as shown in the following figure.
2. Select **Host** and **FS Downstream Signal Quality** in the USB Test Wizard on the oscilloscope.
3. Plug a Full-Speed (or High-Speed) device into the last hub and verify enumeration. If the device fails to enumerate, this could be due to low receiver sensitivity. Remove the last hub in the chain and repeat the enumeration. The tier control in the USB Test Wizard should be set to 6 when all hubs in the chain are being used. Decrease this number for each hubs that must be removed to achieve enumeration.

Note: The USB-IF High-Speed Electrical Test Tool is not used for this test and should not be running

4. Follow the steps in the USB Test Wizard on the instrument display to capture the appropriate waveform. It may be necessary to repeat the acquisition to capture a full screen of data. Use the cursors to select the downstream portion of the data packet (as the following figure shows). The cursors are set to 1 UI before the first bit in the sync field on the left and 1 UI after the end of the EOP on the right. The software then generates an HTML report on the signal quality.

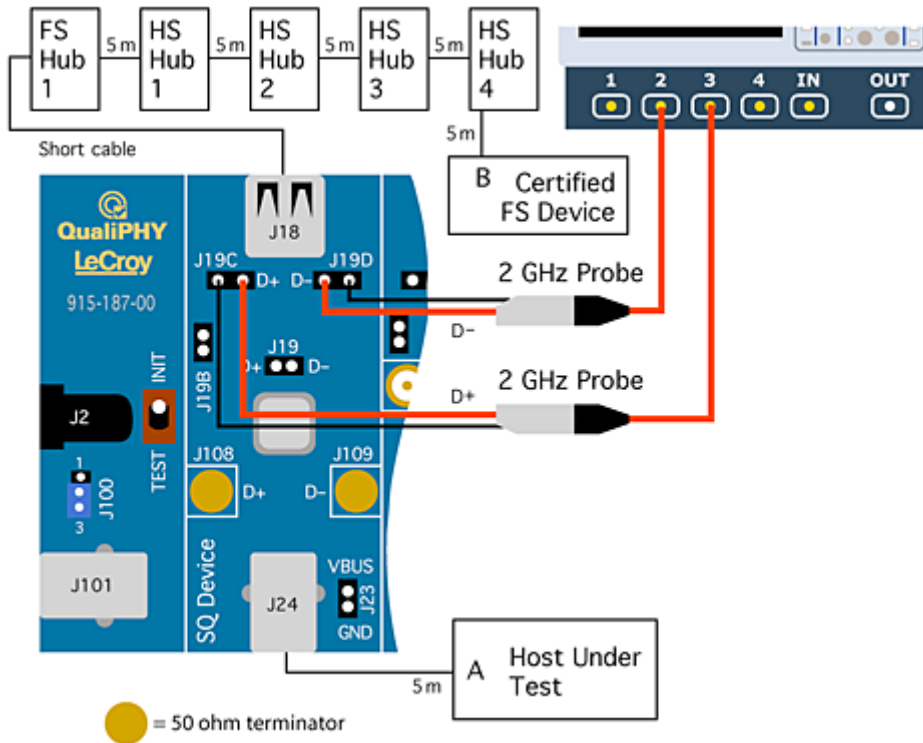

Figure 55. Host Full-Speed Downstream Signal Quality Test Equipment Setup

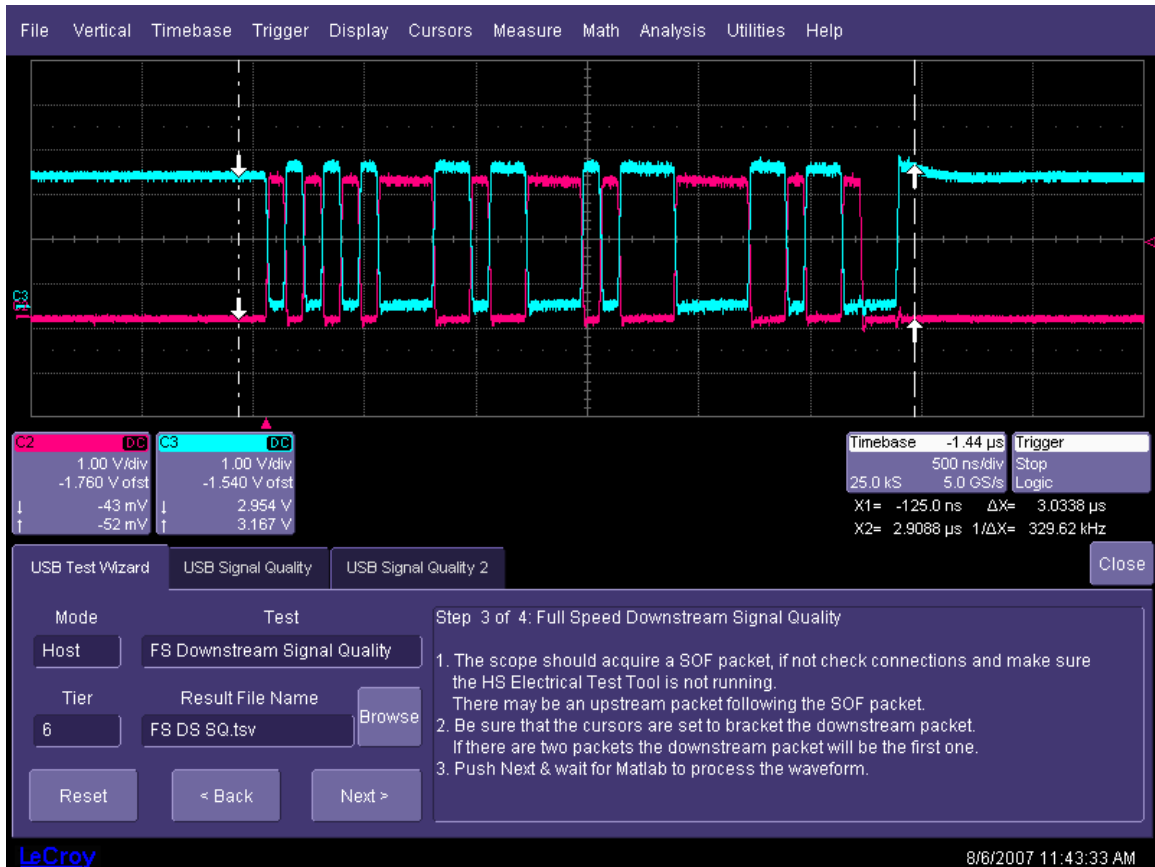

Figure 56. Cursor Positioning for Host Full-Speed Downstream Signal Quality

Inrush Current

Inrush current is generated by devices when they are connected to a hub or host. Self-powered devices should have negligible inrush current. So, this test normally does not indicate any inrush current for such devices. Inrush is measured using the **Inrush** section of the test fixture.

The arrow on the current probe must point in the same direction as the arrow on the Test Fixture. The current probe (a Teledyne LeCroy CP030, or equivalent) is attached to channel 4 of the oscilloscope. The oscilloscope is set to trigger on the rising edge of the current pulse measured on channel 4. Problems associated with switch bounce are avoided when initiating the inrush measurement by plugging the device under test into the Inrush section of the Test Fixture.

The sequence of operations is:

1. Move the switch in the Inrush section from the **ON** position to the **Discharge** position.
2. Unplug the device under test.
3. Move the switch back to the **ON** position. The oscilloscope may trigger and capture a waveform.
4. Plug the device under test into the Inrush port. The oscilloscope triggers again and captures a current waveform as follows:

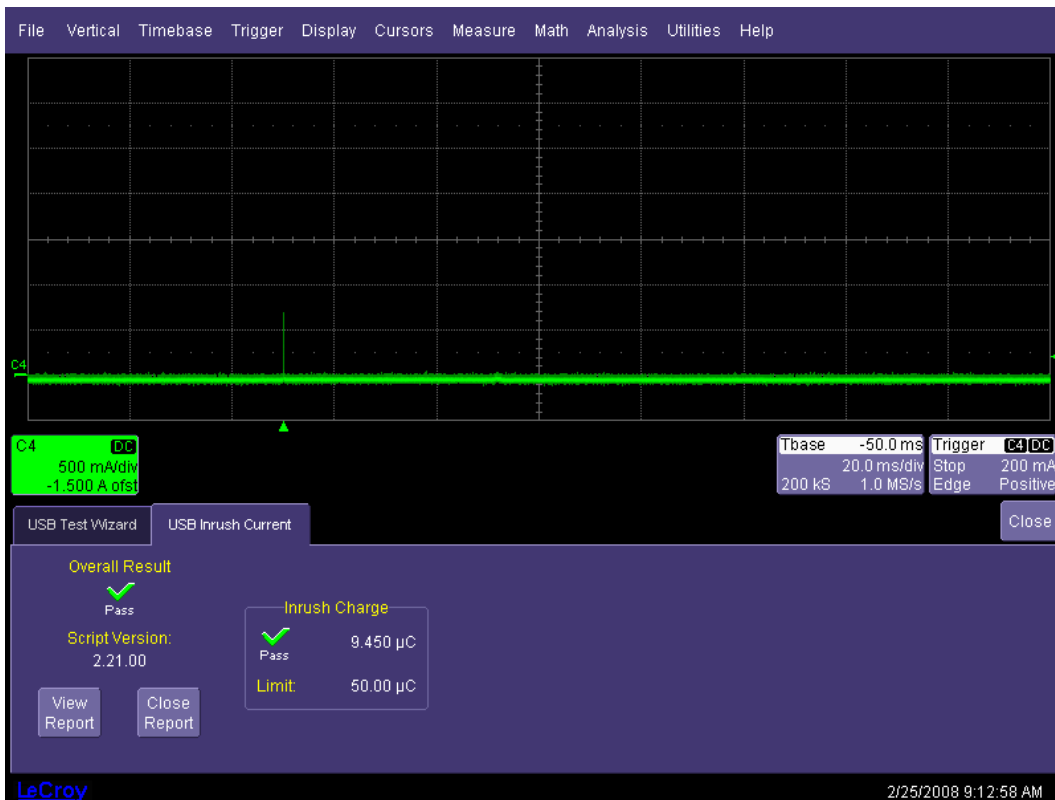

Figure 57. Inrush Current Pulse

5. If the waveform's vertical amplitude is too small or too large (off the screen), adjust the vertical scale of channel 4 and repeat steps 1 through 4 (previous). The inrush current is measured for a minimum of 100ms after attach. Repeat the steps until a good current trace is captured.

The inrush test measures regions where the current exceeds 100mA for at least 100µs. The region containing the most charge is used to determine pass or fail. The inrush test integrates the current in each region to obtain the total charge for each. The USB specification requires the total charge in each region be less than 50µC.

- The software then generates an HTML report on the inrush.

Hub Down Stream Low-Speed Signal Quality

- Set up the equipment as follows. The hub is tested at tier 5 (at the end of a chain of four hubs) connected to a device at tier 6. The first hub in the chain should be a USB Full-Speed hub. The chain of hubs is intended to test the receiver sensitivity of the hub.
- Start the USB High-Speed Electrical Test Tool, select **Device**, and then press **Test**. Press **Enumerate Bus** and verify the hub under test appears in the Select Device window.
- A Low-Speed device (mouse) is connected between a downstream port of the hub under test through the Inrush section of the Test Fixture. Make sure the Inrush switch is in the **ON** position.
- Select **Hub** in the mode control and **LS Downstream Signal Quality** in the test control of the USB Test Wizard. The trigger is set up to acquire a waveform on the oscilloscope on the rising edge of the D- line in Single trigger mode.
- Press the **Single trigger** button on the oscilloscope until a full packet is captured on the screen. Use the cursors to select the downstream portion of the data packet as the following figure shows. The cursors are set to 1 UI before the first bit in the sync field on the left and 1 UI after the end of the EOP on the right.
- Press **Next** in the USB Test Wizard to process the waveform. MATLAB generates an eye pattern waveform file and an HTML signal quality report. These files are stored in the D:\Applications\USB2\Results directory.

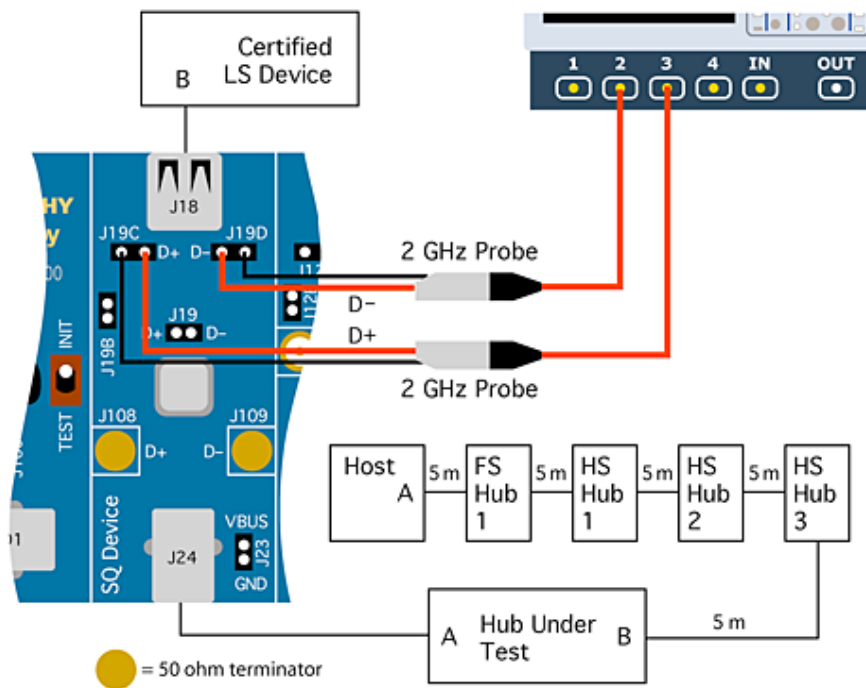

Figure 58. Hub Low-Speed Downstream Signal Quality Setup

Hub Full-Speed Downstream Signal Quality

1. Set up the equipment as follows. The hub is tested at tier 5 (at the end of a chain of 4 hubs) connected to a device at tier 6. The first hub in the chain should be a USB Full-Speed hub. The chain of hubs is intended to test the receiver sensitivity of the hub.

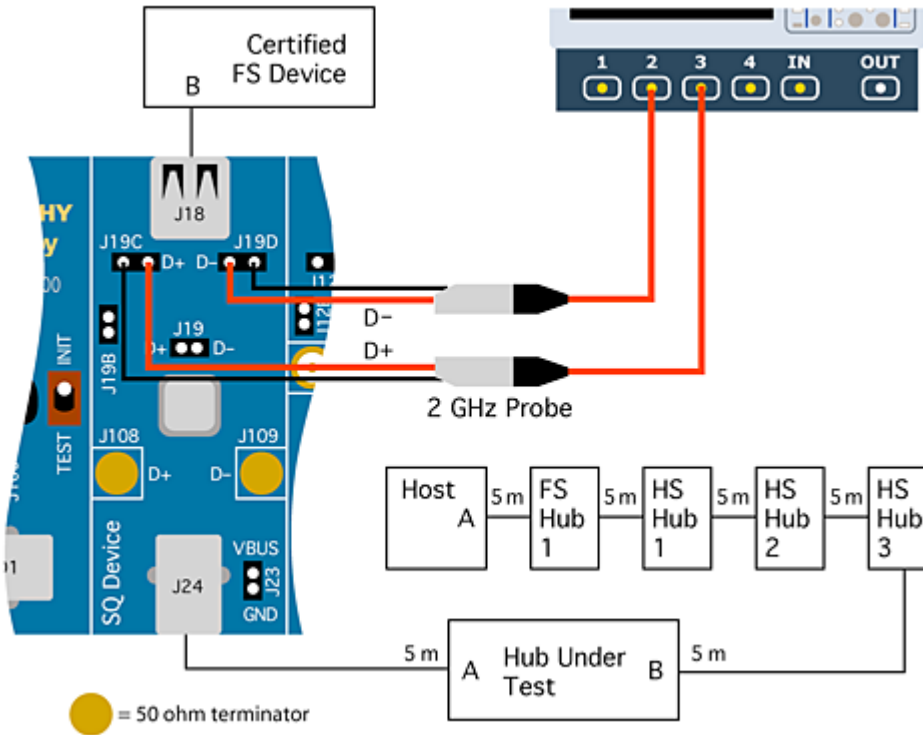

Figure 59. Hub Full-Speed Downstream Signal Quality Setup

1. Start the USB High-Speed Electrical Test Tool, select **Device**, and then press **Test**.
2. Press **Enumerate Bus** and verify the hub under test appears in the Select Device window.
3. A Full-Speed device is connected to the downstream port of the hub under test through the SQ Device section of the Test Fixture.
4. Select **Hub** in the mode control and **FS Downstream Signal Quality** in the test control of the USB Test Wizard.
5. Press the **Single Trigger** front panel button on the oscilloscope until a full packet is captured on the screen. Use the cursors to select the downstream portion of the data packet (as the following figure shows). The cursors are set to 1 UI before the first bit in the sync field on the left and 1 UI after the end of the EOP on the right.
6. Press **Next** in the USB Test Wizard to process the waveform. MATLAB generates an eye pattern waveform file and an HTML signal quality report. These files are stored in the D:\Applications\USB2\Results directory.

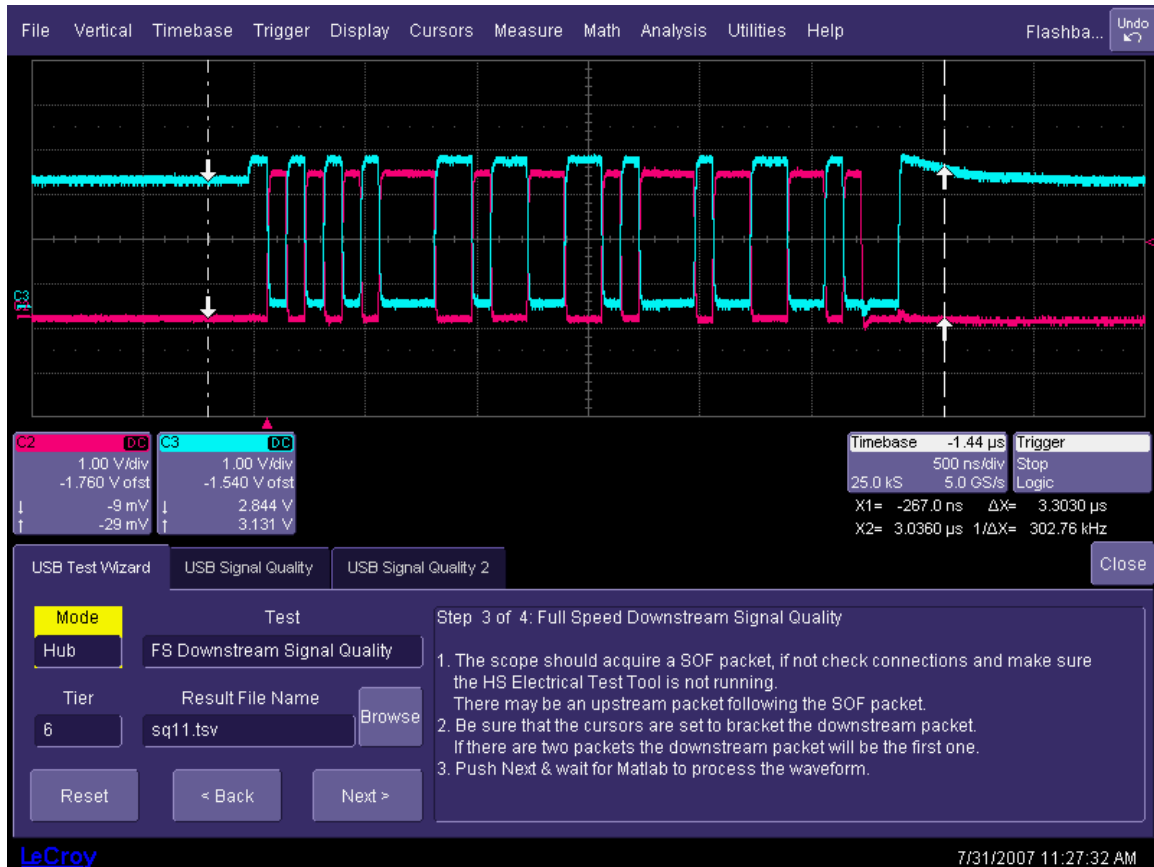

Figure 60. Cursor Placement For Hub FS Downstream Signal Quality Test

Device and Hub Full-Speed Upstream Signal Quality Test

Upstream signal quality is tested for both hubs and devices and at both Full- and Low-Speed. USB 2.0 devices require only the Full-Speed mode to be tested. The following setup is used in all cases (Full-Speed setup is shown, Low-Speed is similar). The device or hub under test is connected to the last hub in the chain through the Inrush section of the Test Fixture. A second device is connected to the hub through the Trigger section of the Test Fixture. The second device must be a Low-Speed device for Low-Speed testing or a Full-Speed device for Full-Speed testing. For Low-Speed testing C1 is connected to D- (J26D). The chain of hubs is intended to test the receiver sensitivity of the hub or device.

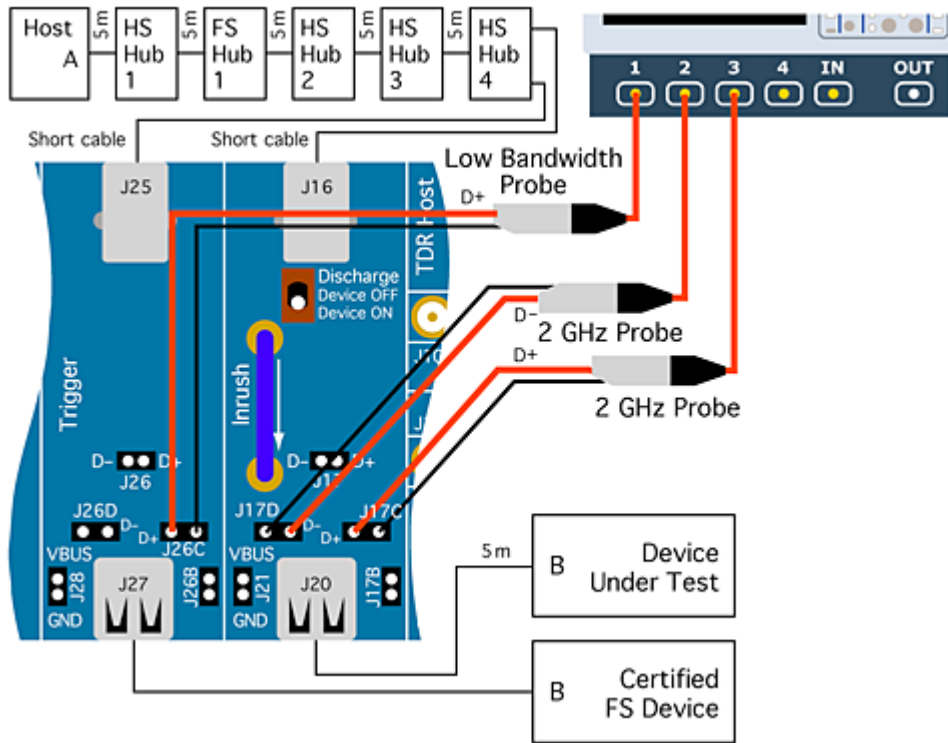

Figure 61. Device Full-Speed Upstream Signal Quality Test Equipment Setup

Device and Hub Full- or Low-Speed Upstream Signal Quality Test

1. Start the USB High-Speed Electrical Test Tool, select **Device** and then press **Test**.
2. Press **Enumerate Bus** and verify that the hub or device under test appears in the Select Device window. If the hub or device under test fails to enumerate, remove Full-Speed hubs one at a time from the end of the chain until it does. The number of hubs between the host and the device under test plus one is the tier at which the enumeration takes place.
3. Select the device or hub under test from the list in the Select Device window of the USB High-Speed Electrical Test Tool and select **LOOP DEVICE DESCRIPTOR** in the Device Command control.
4. In the USB Test Wizard, select the appropriate mode (**Hub** or **Device**) and the appropriate test (**FS** or **LS Upstream Signal Quality**).
5. Press the **Single Trigger** front panel button until a complete packet is captured. The waveform consists of both downstream and upstream data. The upstream portion corresponds to the part of the differential signal (channels 2 and 3) after the last bit in the trigger channel (channel 1). Use the cursors to select the downstream portion of the data packet (as the following figure shows). The cursors are set to 1 UI before the first bit in the sync field on the left and 1 UI after the end of the EOP on the right.

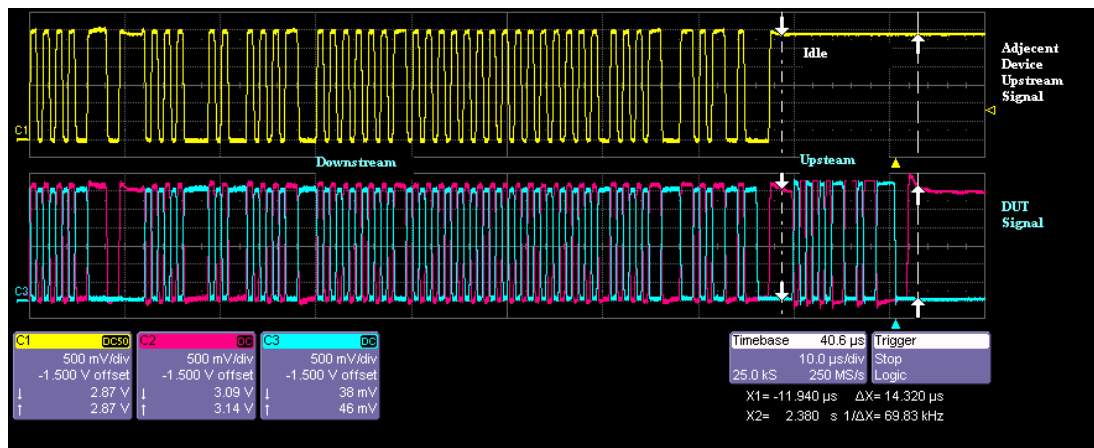

Figure 62. Isolation of Upstream Data Packet

6. Press **Next** in the USB Test Wizard to process the waveform. MATLAB generates an eye pattern waveform file and an HTML signal quality report. These files are stored in the D:\Applications\USB2\Results directory.

TF-USB-B Test and Calibration Procedures

The following procedure demonstrates how to deskew two oscilloscope channels and cables using the differential data signal, with no need for any “T” connector or adapters.

This can be done once the temperature of the oscilloscope is stable. The oscilloscope must be warmed up for at least a half-hour before proceeding. This procedure should be run again if the temperature of the oscilloscope changes by more than a few degree.

1. Connect a differential data signal to C2 and C3 using two approximately matching cables. Set up the oscilloscope to use the maximum sample rate. Set the timebase for a few repetitions of the pattern (at least a few dozen edges).

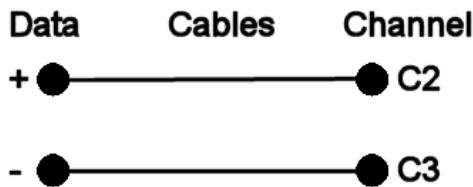

2. On the C3 menu, check **Invert**. Now C2 and C3 should look the same.
3. Using the **Measure Setup**, set P1 to measure the Skew of C2, C3. Turn on **Statistics (Measure menu)**. Write down the mean skew value after it stabilizes. This mean skew value is the addition of Data skew + cable skew + channel skew.
4. Swap the cable connections on the Data source side (on the test fixture), and then press the **Clear Sweeps** button on the oscilloscope (to clear the accumulated statistics; since we changed the input).

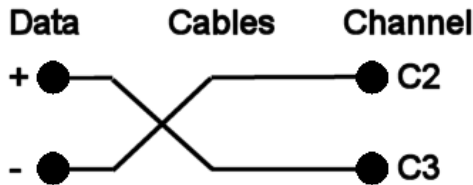

5. Write down the mean skew value after it stabilizes. This mean skew value is the addition of (-Data skew) + cable skew + channel skew.
6. Add the two mean skew values and divide the sum in half:

$$\frac{[\text{Data skew} + \text{cable skew} + \text{channel skew}] + [(-\text{Data skew}) + \text{cable skew} + \text{channel skew}]}{2}$$

7. The above formula simplifies to:

$$[\text{cable skew} + \text{channel skew}]$$

8. Set the resulting value as the Deskew value in C2 menu.
9. Restore the cable connections to their Step 1 settings (previous). Press the **Clear Sweeps** button on the oscilloscope. The mean skew value should be approximately zero - that is the data skew. Typically, results are <1ps given a test fixture meant to minimize skew on the differential pair.
10. On the C3 menu, un-check the **Invert** checkbox and turn off the parameters.

In the previous procedure, we used the default setup of the Skew parameter (which is detecting positive edges on both signals at 50%). We also inverted C3 in order to make C2 and C3 both have positive edges at the same time.

Alternately, we clearly could have not inverted C3 and instead selected the Skew clock 2 tab in the P1 parameter menu and set the oscilloscope to look for negative edges on the second input (C3). However, it is somewhat agreed that the previous procedure looks much more aesthetically pleasing from the display as it shows C2 and C3 with the same polarity.

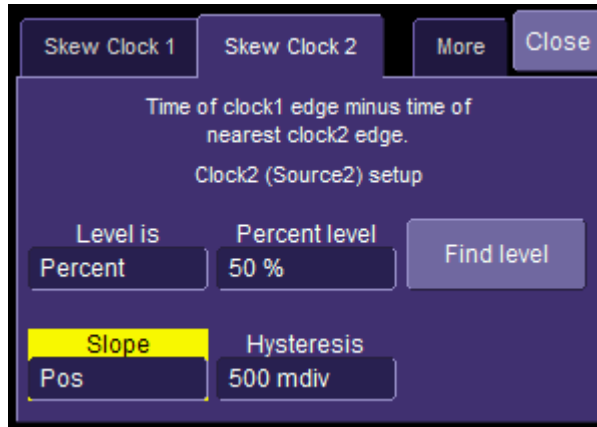

Receiver Sensitivity Test Waveform Setup

This section describes the characteristics of the required waveforms used for device or hub receiver sensitivity testing. Either a two channel pattern generator, such as the Agilent 81130A, or a two channel arbitrary waveform generator (AWG) can be used. Two Tabor WW1281A one channel AWG can also be used with a specific synchronization cable. The specific steps used to create the waveforms will vary depending on the model of generator being used. Please consult the documentation for details.

MIN_ADD1

Description: IN Token of nominal bitrate and amplitude with the shortest allowable sync field (12 bits).

Bitrate: 480 Mb/s

High Level (both channels): 400 mV

Low Level (both channels): 0 mV

Pattern length: 44 bits

Repetition Rate: 2 us (both channels should be at 0 mV for 916 bits following the pattern)

Pattern bits:

	1	2	3	4	5	6	7	8	9	10	11	12
CH1 (D+)	0	1	0	1	0	1	0	1	0	1	0	0
CH2 (D-)	1	0	1	0	1	0	1	0	1	0	1	1

	13	14	15	16	17	18	19	20	21	22	23	24	25	26	27	28
CH1 (D+)	0	1	0	0	1	1	1	0	0	1	0	1	0	1	0	1
CH2 (D-)	1	0	1	1	0	0	0	1	1	0	1	0	1	0	1	0

	29	30	31	32	33	34	35	36	37	38	39	40	41	42	43	44
CH1 (D+)	0	1	0	0	1	1	1	1	0	0	0	0	0	0	0	0
CH2 (D-)	1	0	1	1	0	0	0	0	1	1	1	1	1	1	1	1

IN_ADD1

Description: IN Token of nominal bitrate, amplitude and sync field (32 bits).

Bitrate: 480 Mb/s

High Level (both channels): 400 mV

Low Level (both channels): 0 mV

Pattern length: 64 bits

Repetition Rate: 2 us (both channels should be at 0 mV for 896 bits following the pattern)

Pattern bits:

	1	2	3	4	5	6	7	8	9	10	11	12	13	14	15	16
CH1 (D+)	0	1	0	1	0	1	0	1	0	1	0	1	0	1	0	1
CH2 (D-)	1	0	1	0	1	0	1	0	1	0	1	0	1	0	1	0

	17	18	19	20	21	22	23	24	25	26	27	28	29	30	31	32
CH1 (D+)	0	1	0	1	0	1	0	1	0	1	0	1	0	1	0	0
CH2 (D-)	1	0	1	0	1	0	1	0	1	0	1	0	1	0	1	1

	33	34	35	36	37	38	39	40	41	42	43	44	45	46	47	48
CH1 (D+)	0	1	0	0	1	1	1	0	0	1	0	1	0	1	0	1
CH2 (D-)	1	0	1	1	0	0	0	1	1	0	1	0	1	0	1	0

	49	50	51	52	53	54	55	56	57	58	59	60	61	62	63	64
CH1 (D+)	0	1	0	0	1	1	1	1	0	0	0	0	0	0	0	0
CH2 (D-)	1	0	1	1	0	0	0	0	1	1	1	1	1	1	1	1

Note: If the minimum voltage step on the generator is greater than or equal to 50 mV, 6dB attenuators should be used to get a finer minimum voltage step. These attenuators will reduce the output voltage by approximately half, so the voltage levels on the generator should be doubled.