

MP1590B

Network Performance Tester



All-In-One Next-Generation Network Testing SDH/SONET/OTN/PDH/DSn/Jitter/EoS/Ethernet/IP Analyzer

The dawn of the NGN era and the spread of high value-added and seamless networks are driving the need for high-level testing and evaluation of these networks and their network devices.

Using modular plug-in units, Anritsu's MP1590B supports performance, jitter, and EOS measurements of networks, equipment and devices with SDH/SONET/OTN/PDH/DSn interfaces. The MP1590B also supports both Ethernet and IP technologies with a variety of applications such as QoS and IPTV streaming service tests.

This tester family is the perfect tool for performing the wide range of measurements covering the physical to application layers needed for constructing next-generation networks.

- **Simultaneous Multichannel Measurement**
- **An all-in-one instrument for measuring SDH/SONET/OTN/PDH/DSn/Jitter performance**
- **Supports EoS (GFP, VCAT, LCAS, Differential Delay) measurements**
- **Supports 10/100/1000M, Gigabit, and 10 Gigabit Ethernet measurements**

MP1590B Main Frame

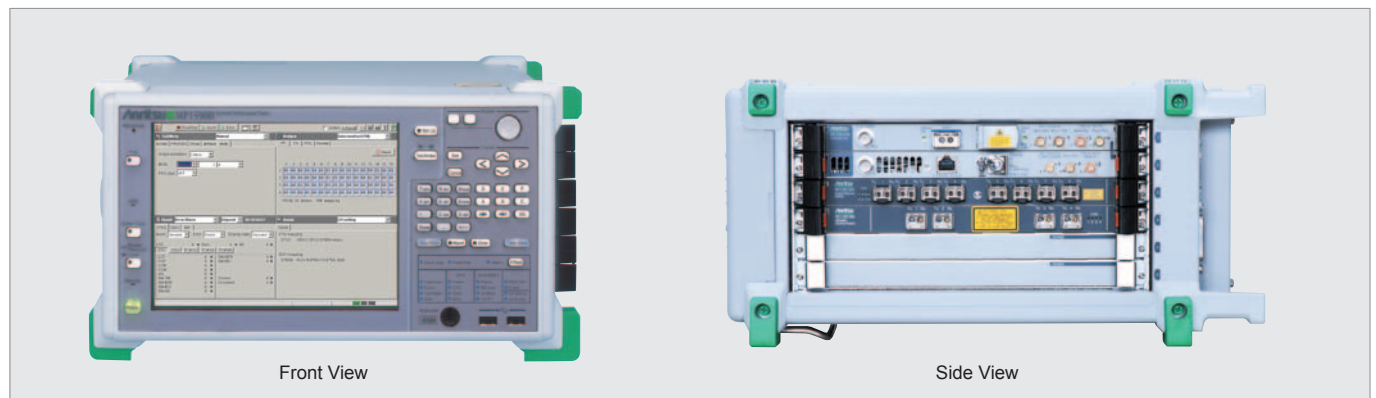

6-slot Integrated screen model
 Built-in Windows® XP operating system
 Dimensions: 320 (W) × 177 (H) × 350 (D) mm
 Mass: 13 kg max. (excl. options and units)

*: Windows® is a registered trademark of Microsoft Corporation in the United States and other countries.

SDH/SONET/OTN/PDH/DSn/Jitter/EoS Unit

■ **Measurement Units: Frame Generation/Detection**

MU150110A Multirate Unit



- PDH/DSn Measurement
- SDH/SONET (STM-0/OC-1 to STM-64/OC-192) Measurement
- OTN (OTU1, OTU2) Measurement (Option-005)
- OTN (OTU1e, OTU2e) Measurement (Option-006)
- 10G Ethernet Measurement (Option-008)
- Multichannel Measurement (Option-010)

MU150101A 2.5/2.6G EoS Unit



- PDH/DSn Measurement
- SDH/SONET (STM-0/OC-1 to STM-16/OC-48) Measurement
- EoS Measurement (Option-06, 07, 11, 12, 13, 14)

MU150125A 10/10.7G Jitter Unit



- Bit Rate: 52 Mbit/s to 10.7 Gbit/s
- Jitter Generation Measurement
- Jitter Tolerance Measurement
- Jitter Transfer Measurement

Interface Units: 10/10.3/10.7G Optical/Electrical Interfaces

MU150121A 10/10.7G Optical Unit (Tx)



Interface: Optical Output
Bit rate: 9.95328 Gbit/s, 10.709225 Gbit/s

MU150121B 10/10.7G Optical/Electrical Unit (Tx)



Interface: Optical/Electrical Differential Output
Bit rate: 9.95328 Gbit/s, 10.3125 Gbit/s, 10.709225 Gbit/s

MU150123A 10/10.7G Optical Unit (Rx Wide)



Interface: Optical Input
Bit rate: 9.95328 Gbit/s, 10.709225 Gbit/s

MU150123B 10/10.7G Optical/Electrical Unit (Rx Wide)



Interface: Optical/Electrical Differential Input
Bit rate: 9.95328 Gbit/s, 10.3125 Gbit/s (without jitter measurement), 10.709225 Gbit/s

MU150124B 10.3G Optical/Electrical Unit (Rx Wide)



Interface: Optical/Electrical Differential Input
Bit rate: 9.95328 Gbit/s (without jitter measurement), 10.3125 Gbit/s, 10.709225 Gbit/s (without jitter measurement)

Ethernet Units

Express Flow Module: High-port-density models supporting Multiflow Counter, High Resolution Traffic Monitor, Ethernet OAM, Link Flap

MU120131A 10/100/1000M Ethernet Module



Interface: 10BASE-T, 100BASE-TX, 1000BASE-T
Port Number: 12

MU120132A Gigabit Ethernet Module



Interface: 1000BASE-SX/LX/LE/LR (SFP Module)
Port Number: 8

MU120138A 10 Gigabit Ethernet Module



Interface: 10GBASE-SR/LR (SFP+ Module)
Port Number: 4

Power Protocol Module: High-performance protocol models supporting Multiflow Counter, High Resolution Traffic Monitor, Ethernet OAM, Traffic Impairment Emulator

MU120121A 10/100/1000M Ethernet Module



Interface: 10BASE-T, 100BASE-TX, 1000BASE-T
Port Number: 4

MU120122A Gigabit Ethernet Module



Interface: 10BASE-T, 100BASE-TX, 1000BASE-T, 1000BASE-SX/LX/LE/LR (SFP Module)
Port Number: 4 (Electrical: 2; Optical: 2)

Basic Module: Basic-performance models

MU120111A 10/100M Ethernet Module



Interface: 10BASE-T, 100BASE-TX
Port Number: 8

MU120112A Gigabit Ethernet Module



Interface: 1000BASE-SX/LX/LH/ZX/T (GBIC Module)
Port Number: 2

MU120118B/C 10 Gigabit Ethernet Module



Interface: 10GBASE-SR/LR/ER (XENPAK Module)
Port Number: 2 (MU120118B), 1 (MU120118C)



Main Applications

SDH/SONET/OTN/PDH/DSn/10G Ethernet Performance Measurements

The MP1590B supports ITU-T, Telcordia and IEEE compliance tests of 1.5M to 11.1G SDH/SONET/OTN/PDH/DSn/10G Ethernet equipment. The following functions can be used to evaluate the performance of networks, equipment, and devices supporting these standards:

- Multichannel Measurement
- Error/Alarm Measurements
- Alarm Detection and Removal Conditions Setting Function
- Delay Time Measurement
- APS (Automatic Protection Switching) Measurement
- Through Mode Function
- Overhead Editing Function
- Monitor Functions
- Unframe BER Measurement
- Variable Frequency Offset Function
- FEC Performance Measurement
- 10G Ethernet Measurement

Sending remote control commands via the Ethernet/RS-232C/GPIB interfaces makes it easy to configure a customized measurement environment for maintenance, installation, R&D, and manufacturing.

Different bit rates can be specified for MP1590B Tx and Rx signals. This means that line- and client-side equipment and networks can be tested simultaneously, supporting configuration of an efficient measurement environment.

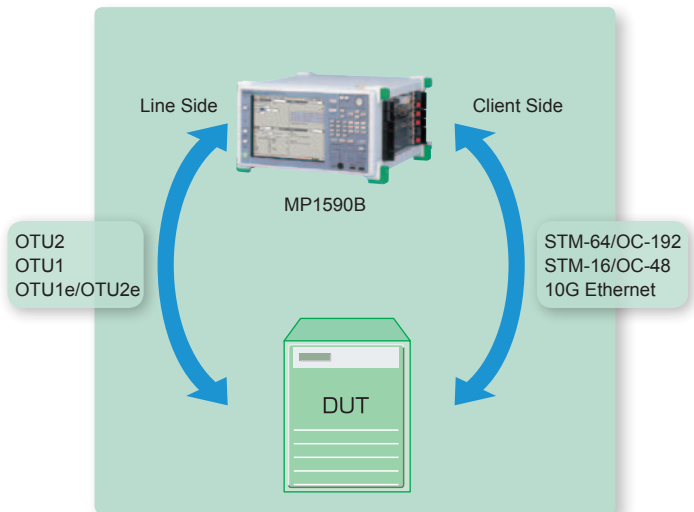

See page 6 for function details, page 14 for the list of functions and supported mappings, and page 18 for the specifications of the main frame and plug-in modules.

SDH/SONET/OTN Jitter Measurements

Jitter is a key index expressing the performance and quality of SDH/SONET and OTN transmission equipment and devices. Jitter evaluation is also an important part of assuring interoperability and network stability. The MP1590B supports the following ITU-T and Telcordia-compliant SDH/SONET/OTN measurements from 52 Mbit/s to 10.7 Gbit/s:

- Jitter Generation Measurement
- Jitter Tolerance Measurement
- Jitter Transfer Measurement

The user can set any mask standard values for these measurements. Because the MP1590B supports optical, electrical and electrical differential (10G band only) interfaces, network equipment jitter as well as device and optical module jitter can be measured. In the 10G band, jitter measurement of 10.3 Gbit/s transfers used by 10G Ethernet can be measured.

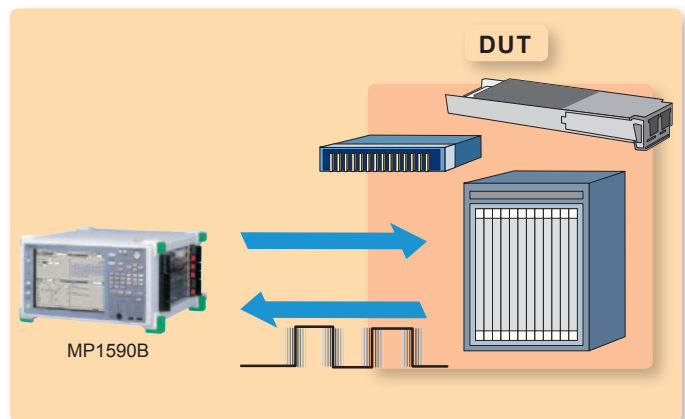

When required, a high-accuracy jitter measurement option can be installed in the MP1590B to perform high-accuracy and high-repeatability measurements with calibration based on Appendix VIII of the April 2005 ITU-T O.172 standard. But even without this option, jitter measurement is still in full compliance with the April 2005 ITU-T O.172 standards.

See page 8 for details of individual functions, page 14 for the list of functions and supported mappings, and page 18 for the specifications of the main frame and plug-in modules.

Anritsu is a proactive member of the ITU-T standardization working groups and has extensive knowledge and practical experience of jitter measurement that is incorporated in the MP1590B.

EoS (Ethernet over SDH/SONET) Measurements

The MP1590B supports the following measurements for next-generation SDH/SONET:

- GFP-F, LEX, LAPS (X.86), PPP Encapsulation
- Virtual Concatenation Member Editing Function
- Virtual Concatenation Group (VCG) Auto-detect Function
- Differential Delay Add/Monitor Function
- LCAS Autonegotiation Function
- LCAS Sequence Generation/Capture Function
- Path Monitor Function

See page 9 for function details.

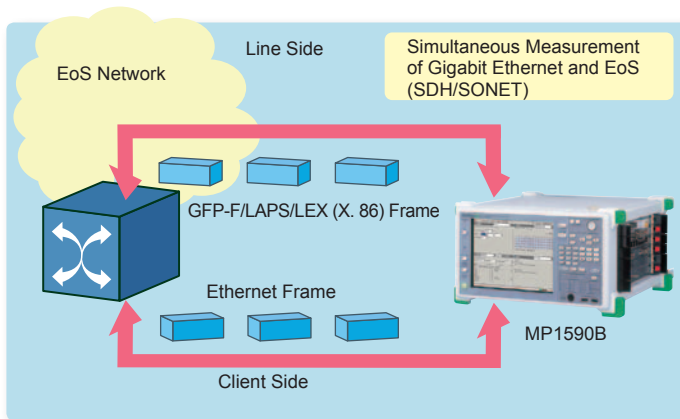

The following measurements are supported because the MP1590B can generate GFP-F, LEX, and LAPS (X.86) encapsulated EoS frames, even when VLAN tags and IP and TCP/UDP headers are attached. Adding an Ethernet unit to the configuration enables a seamless client- and line-side measurement environment using only one main frame.

- Load Tests
 - Stream Generation
 - Variable Tx Clock Offset
- Traffic Measurement
 - Various Counters
 - Packet Jitter/Latency
 - Through Mode
 - Frequency Measurement

See page 10 for function details.

- Packet Analysis
 - Packet Capture/Protocol Decode

In addition to EoS measurements, the MU150101A 2.5/2.6G EoS Unit used here also supports POS measurements and performance measurements of 1.5 Mbit/s to 2.6 Gbit/s SDH/SONET/OTN/PDH/DSn, facilitating a wide range of applications.

See pages 13 and 14 for the list of functions and supported mappings, and page 18 for the specifications of the main frame and plug-in modules.

Ethernet Performance Measurement

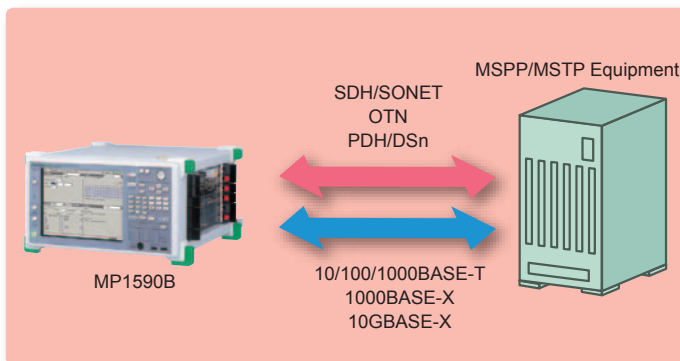

The MP1590B supports 10/100/1000BASE-T, 1000BASE-X, and 10GBASE-X Ethernet measurements using plug-in Ethernet modules. As a result, a single unit can measure the performance MSPP/MSTP equipment used in combination with SDH/SONET/OTN/PDH/DSn plug-in modules.

By taking advantage of the Ethernet module functions listed on the right, they can also be used as genuine IP testers for Ethernet interfaces. See the MD1230 family catalog for the individual Ethernet module specifications.

The MP1590B supports all the key tests of devices and networks, such as load tests, performance tests, traffic measurements, and packet analysis. They can also be used for IPV6 measurements, RFC2544/RFC2889 auto-measurements, auto-negotiation analysis, Ethernet OAM emulation, and more.

- Load Tests
 - Stream Generation
 - Variable Tx Clock Offset
 - Traffic Impairment Emulation
- Traffic Measurement
 - Various Counters/Multiflow Counters
 - High-Resolution Traffic Monitor
 - Packet Jitter/Latency
 - Through Mode
 - Frequency Measurement
- Packet Analysis
 - Packet Capture/Protocol Decode
- Auto-measurement
 - RFC2544/RFC2889 Auto-measurement

See page 10 for function details, page 13 for the list of functions and page 18 for the specifications of each main frame.

Individual Applications

SDH/SONET/OTN/PDH/DSn/10G Ethernet Performance Measurements

Multichannel Measurement

SDH/SONET signal channel configurations ranging from STM-0/OC-1 to STM-64/OC-192 are detected automatically and the performance (errors, alarms, BER, APS, delay time) of all channels including both high and low order (max. 5,376 channels at VC11/VT1.5) can be measured simultaneously, supporting correlation confirmation between channels as well as greatly reduced measurement times.

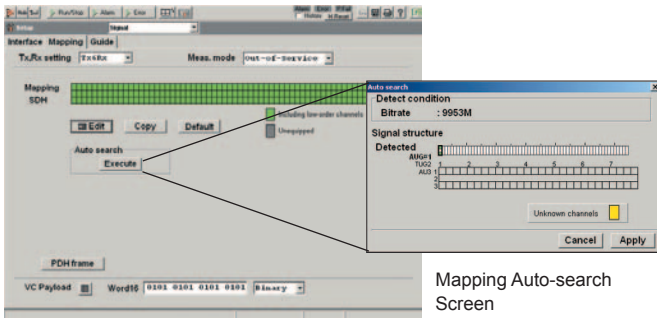

Mapping Auto-search Screen

Error/Alarm Measurements

Errors (such as FAS, BIP-8, and B1/B2/B3) and alarms (such as LOF, LOM, and AIS) can be generated at any timing and counted or monitored by the MP1590B for stress testing SDH/SONET and OTN equipment.

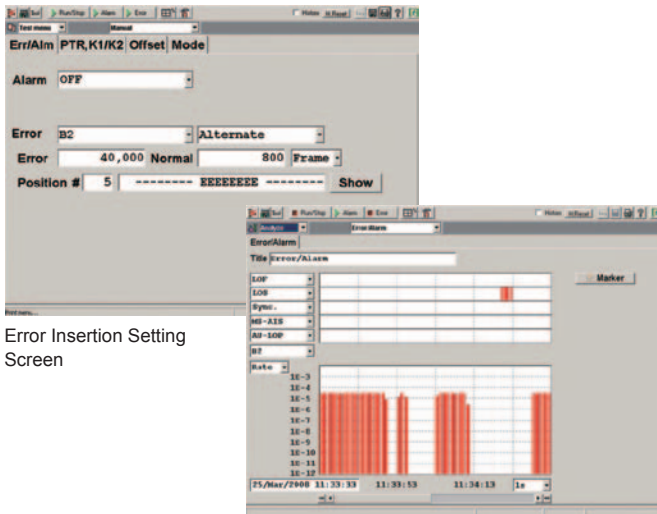

Error Insertion Setting Screen

Error Monitor Screen

Alarm Detection and Removal Condition Setting Function

This function changes the conditions for detecting and removing alarms, making it easy to stress test ITU-T and Telcordia-compliant equipment and networks. This greatly simplifies fault testing.

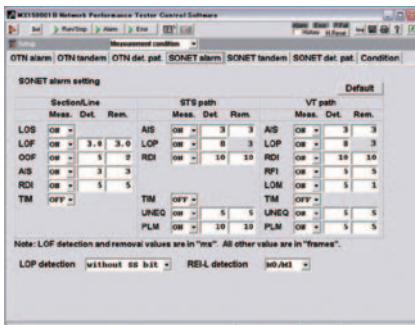

Delay Time Measurement

Network delay is known to be a key factor that directly impacts network quality. This measurement supports measurement of payload data transmission quality to the order of 0.1 μ s.

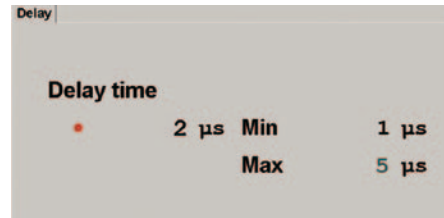

APS Measurements

The Auto Protection Switch (APS) test function checks of equipment switching time with 0.1 ms resolution. The switching time until the fault condition triggered by an error or alarm is released can be measured to check standards-compliant rerouting caused by faults.

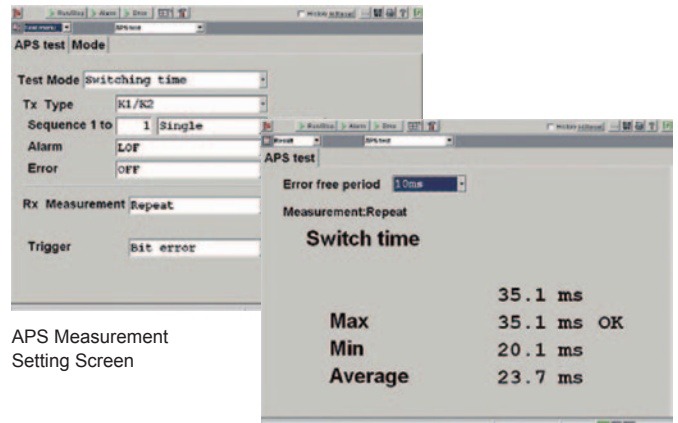

APS Measurement Setting Screen

APS Measurement Results Screen

Through Mode Function

The MP1590B Through mode can be used for all supported bit rates. Connecting devices using this mode allows monitoring the actual signal quality as well as inserting various errors and alarms into the circuit path.

– Transparent Mode –

In this mode, the received signal is looped back as is which is useful for emulating the transmission path because bit error insertion is supported.

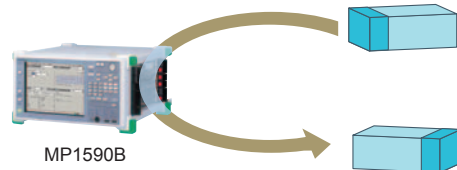

– Overhead Overwrite Mode –

In this loopback mode, the overhead part of the received SDH/SONET/OTN signal can be overwritten with a new overhead specified by the MP1590B in order to emulate various errors and alarms that can occur in actual circuits.

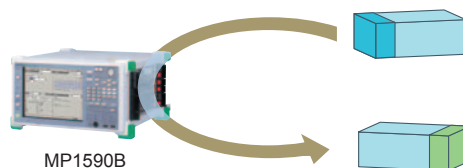

Overhead Editing Function

Tx frame overhead can be changed easily to simplify stress and fault testing of ITU-T and Telcordia-compliant equipment and networks.

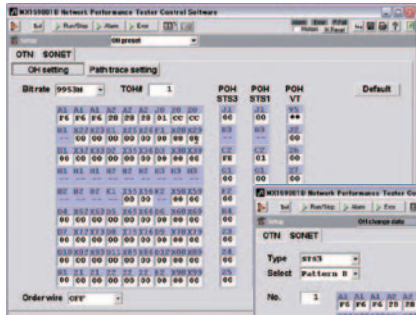

Overhead Preset Screen

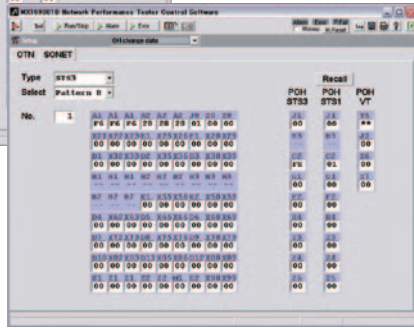

Overhead Test Screen

Monitor Function

Networks are easily monitored using a full line-up of versatile functions for monitoring errors/alarms, frequency, pointers, overhead, optical output power, and more.

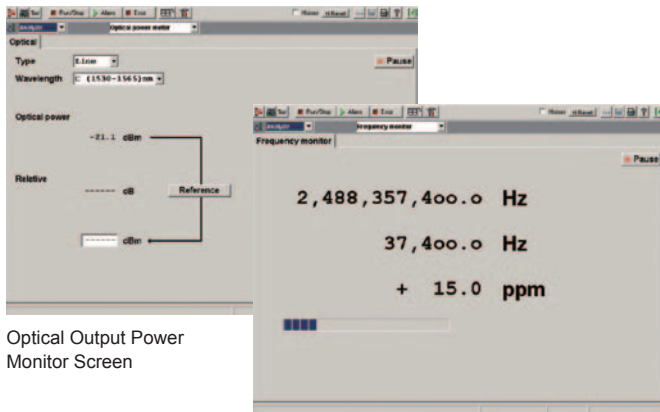

Optical Output Power Monitor Screen

Frequency Monitor Screen

Variable Frequency Offset Function

The MP1590B supports variation of the Tx clock in 0.1 ppm steps over a range of ±100 ppm. They can also send signals synchronized with an external clock source to perform device and network stress tests using degraded clocks exceeding the ITU-T and Telcordia specified ±20 ppm frequency range.

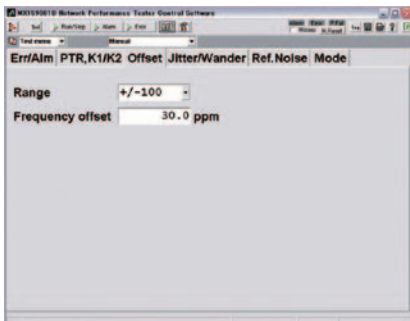

FEC Performance Measurement (OTN-specific)

This function for inserting Poisson-distributed random errors specified by ITU-T O.182 supports easy and high-reproducibility validation of the error-correction performance of FEC decoders, avoiding the use of external equipment such as noise generators. Burst error insertion provides an efficient method of validating FEC burst-error correction performance.

Random Error Insertion using O.182 Method.

This function is required for FEC evaluation. Accurate measurement was impossible using previous error insertion method.

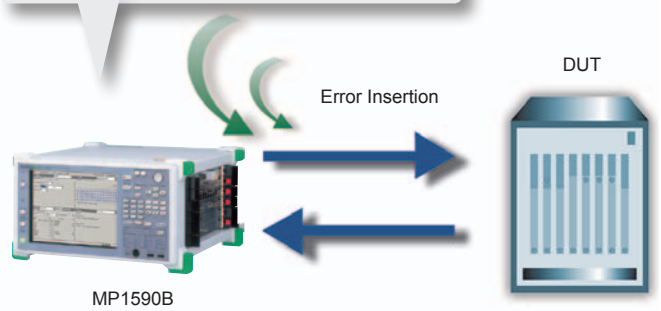

MP1590B

10G Ethernet Measurement

The quality of 10G Ethernet equipment and networks can be evaluated by measuring throughput, BER, sequence errors, and latency. In addition, detailed analysis of the 10G Ethernet Physical layer is supported by functions including measurement of the 64B/66B encoding used by the PCS (Physical Coding Sublayer) layer, LFS (Link Fault Signaling) which performs warning notifications at faults, clock frequency variations, optical power, etc.

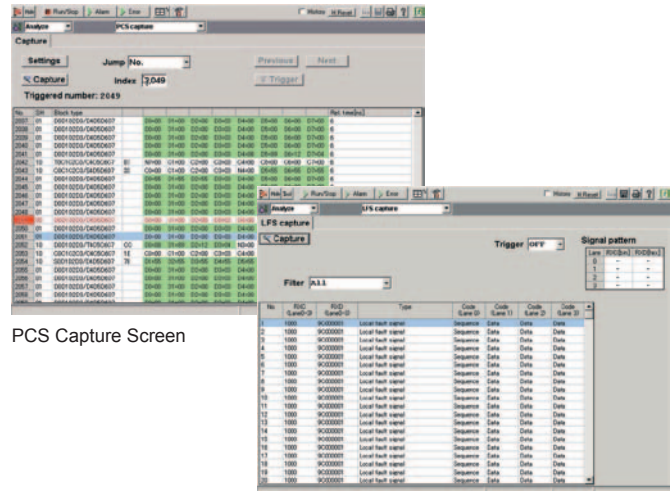

PCS Capture Screen

LFS Capture Screen

SDH/SONET/OTN Jitter Measurements

Using the MU150125A 10/10.7G Jitter Unit supports jitter generation and measurement for SDH/SONET/OTN 52 Mbit/s to 10.7 Gbit/s equipment. Jitter of optical modules such as XFP can be measured by adding options supporting 10.3G.

Jitter Measurements

There are three types of jitter measurement, depending on the purpose, as shown below. The MP1590B simplifies each of these measurements.

Jitter Generation Measurement

The jitter generated at the output side of equipment and devices is measured to check that it is better than the standard value established by ITU-T and Telcordia.

Jitter Tolerance Measurement

The jitter tolerance at the input side required for equipment and devices to operate normally is measured to check that it is better than the standard value established by ITU-T and Telcordia.

Jitter Transfer Measurement

The jitter attenuation characteristics between the jitter input to equipment and devices and the output side is measured to check that it is better than the standard value established by ITU-T and Telcordia.

There is a correlation between jitter generation and jitter tolerance measurements: if both meet the standards, network connection compatibility is assured. Jitter transfer characteristics are a standard for curbing accumulated jitter caused by each unit of connected transmission equipment. Jitter transfer can be a major issue when there is a large number of elements in a long-distance network.

High-Accuracy Jitter Measurements

The MP1590B support a high-accuracy jitter measurement (Option-30) for performing calibration based on the true jitter measurement standard outlined in Appendix VIII of the ITU-T O.172 standard. Installing this option suppresses randomness in the generated jitter to ± 5 mUI, permitting high-accuracy and high-repeatability jitter measurement.

Note 1:

This option can be added to the main frame before delivery. But it cannot be added after.

Note 2:

This option assures high-accuracy jitter measurement only when the factory installation conditions remain unchanged. If a plug-in unit installed along with Option-30 is subsequently replaced or removed, or if another plug-in unit is installed, high-accuracy jitter measurement is no longer assured. However, the function and performance of other measurements (excluding high-accuracy jitter measurement) are still assured.

Note 3:

This option requires periodic calibration at shipment and annually thereafter.

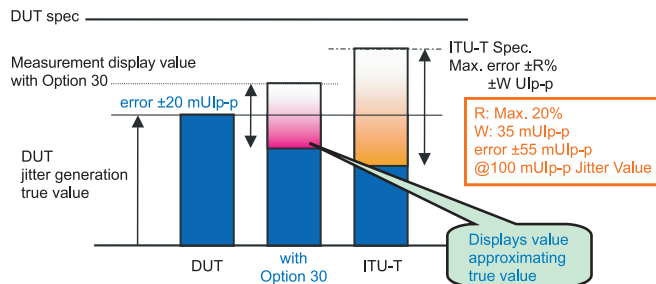

Differential Electrical Interface

Using the MU150121B/23B/24B modules with differential electrical interfaces for 9953M, 10.3G and 10.7G rates supports jitter measurement of the electrical differential interface of optical transceiver modules, such as XFP modules.

Conventionally, jitter measurement of electrical interfaces is performed using framed signals for single-end electrical interfaces. However, measuring the jitter of an optical transceiver module, such as an XFP module, with such single-ended electrical differential interfaces causes large variations in the jitter amount due to the impact of polarity and test patterns. This prevents accurate jitter measurement.

Consequently, it is essential use a differential electrical interface for jitter measurement.

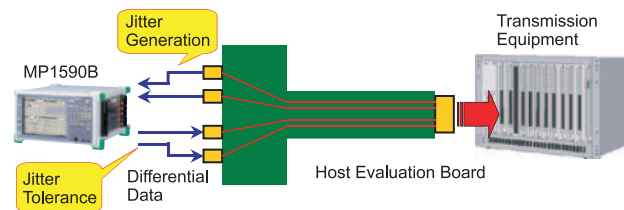
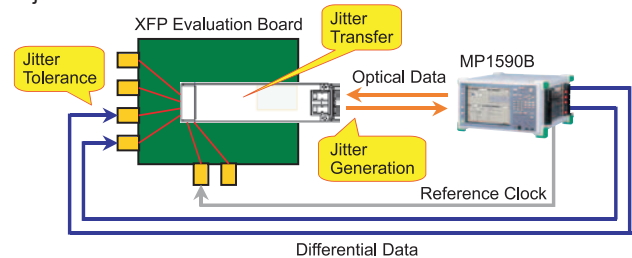

User Mask Settings

The MP1590B can set masks defined by the ITU-T and Telcordia standards as well as any user-defined masks, such as masks with standards-compliant margins.

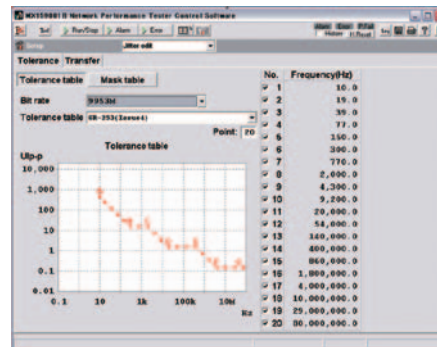

Jitter Tolerance Mask Setting Screen

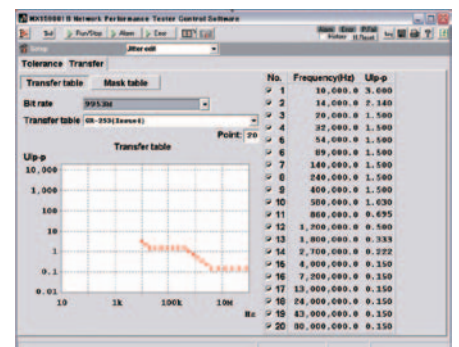

Jitter Transfer Mask Setting Screen

EoS (Ethernet over SDH/SONET) Measurements

Virtual Concatenation (VCAT)

Both high and low-order VCAT are supported. The Virtual Concatenation Group (VCG) can be set for any member position (Channel) and sequence (SQ). Using the VCG auto-detection function allows the tester to capture connected VCG settings easily.



Differential Delay

The differential delay monitor function makes it easy to see the delay status and correlations of each VCG member at a glance. Furthermore, the differential delay generation function supports individual addition of a delay up to 512 ms to each VCG member. There are two built-in delay insertion methods: the Direct mode, in which the new delay is activated as soon as the delay value is input; and the Sweep mode, in which the current delay value is switched to the new input delay value after some period of time as sweeping progresses. Using the Sweep mode supports verification of equipment differential-delay tolerance under conditions emulating a real network where the status changes continually. This function supports both peer-to-peer and through-mode connections.

The differential delay settings support On/Off and sweep amount for each channel, with two target delay settings for configuring a near-to-live network environment.



Differential Delay Setting Screen

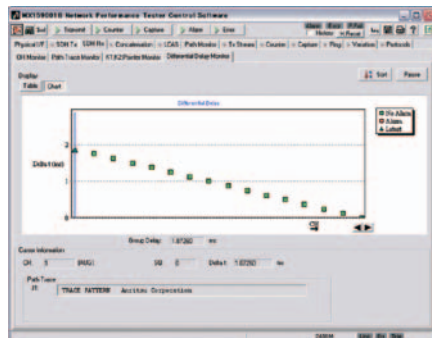

Differential Delay Monitor Screen

LCAS

LCAS emulation, sequence generation, monitor, capture and summary functions are all built-in. The LCAS generation function can generate a maximum of 64 sequences for easy evaluation of functions using multi-LCAS sequences. The LCAS capture function captures a maximum of 64 sequences for detailed analysis of LCAS sequence operations.

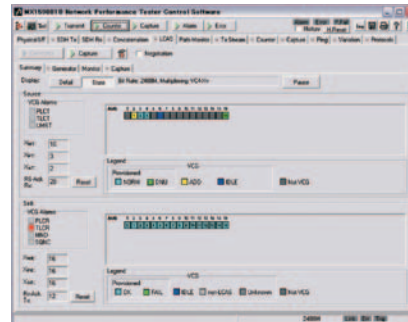

LCAS Summary Display Screen

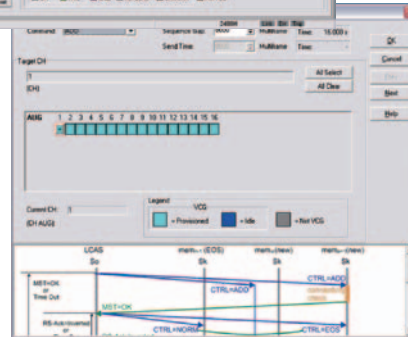

LCAS Sequence Generation Screen

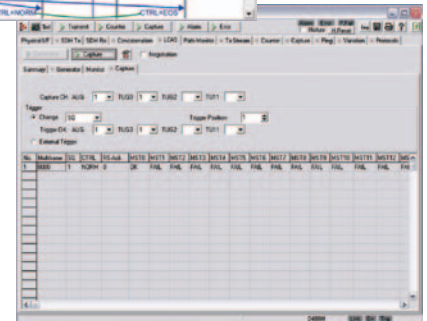

LCAS Sequence Capture Screen

Path Monitor Function

This function supports individual monitoring of errors and alarms for all VCG members. It can be used for detailed analysis to confirm whether an error has occurred during EoS, virtual concatenation, and LCAS measurement. It can also check the member at which the error occurred.

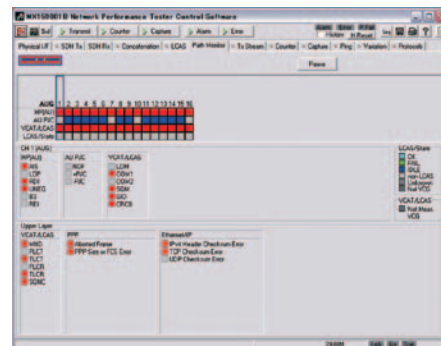

Ethernet Performance Measurements

Load Tests

Stream Generation

This function makes it easy to generate multiflow packet streams and full-wire-rate high-load traffic, which are difficult to achieve manually in a real network environment.

ID	Distribution	Length	Protocol	VLAN...	Errors
<input checked="" type="checkbox"/> 1	Next	Fixed 1518	TCP/IPv4	VLAN	None
<input checked="" type="checkbox"/> 2	Next	Fixed 1518	UDP/IPv4	VLAN	None
<input checked="" type="checkbox"/> 3	Next	Fixed 4096	TCP/IPv4	VLAN	None
<input checked="" type="checkbox"/> 4	Jump to #1 x 10	Fixed 4096	UDP/IPv4	VLAN	None

Variable Clock Offset

A variable clock offset function for sending signals to network equipment is built in and supports clock tolerance measurements of equipment and devices.

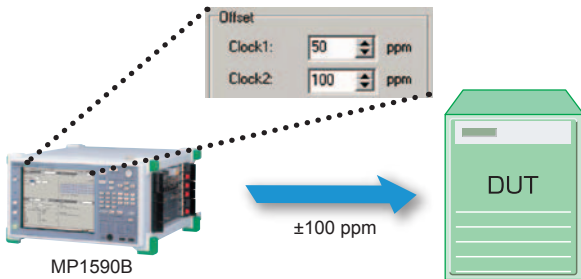

Error Addition

This function adds packet errors to the Tx stream for creating easily reproduced fault conditions.

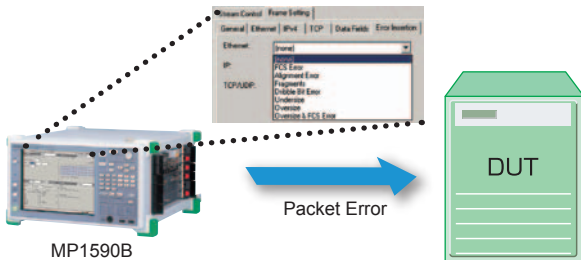

Traffic Impairment Emulator

This function emulates network impairments such as packet loss, errors, and delay that occur in real IPTV and VoIP traffic. It is used to evaluate service quality by assuming various types of network impairments.



Traffic Measurements

Counters

A full lineup of various counters supports traffic measurements by helping detect various network faults.

Multiflow Counter

Simultaneous monitoring of various traffic conditions (throughput, delay, frame loss) helps validate QoS controls and verify their effectiveness.

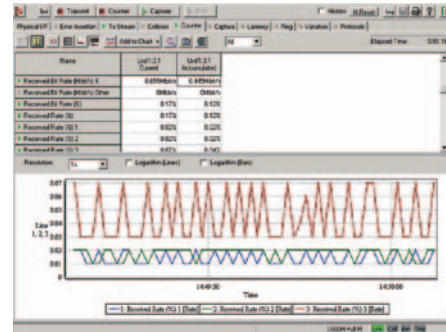

High-Resolution Traffic Monitor

Current measurement methods with a 1-second resolution are inadequate for verifying burst data impacting the quality of streaming services. This function performs monitoring with 1-ms time resolution to analyze burst data with previously unachievable accuracy for assured service quality.

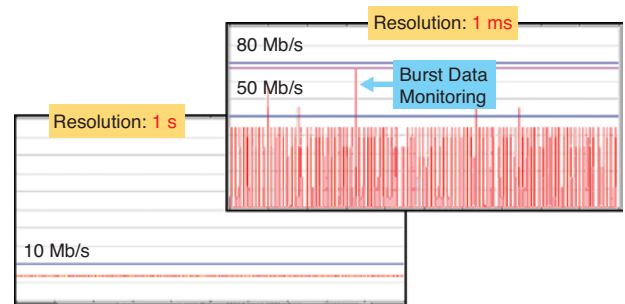

Same Traffic Monitored at Different Resolution

Latency/Packet Jitter

This function supports monitoring of latency and packet jitter, which have serious quality impacts on real-time services.

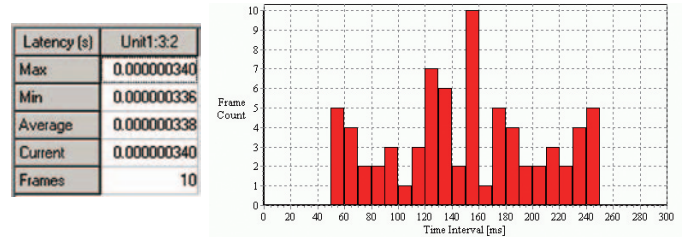

Latency Distribution

Through Mode

Analysis of packet flows between equipment usually requires splitting the signal. The Through Mode function eliminates the need to provide an external splitter, making packet flow analysis easy.

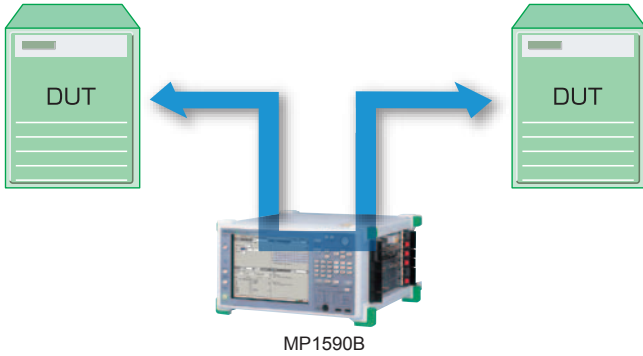

Packet BER Measurement

Measuring bit errors in transmission paths and frame loss at equipment is an important part of improving network reliability. This Packet BER measurement function plays a key role in assuring transmission quality.

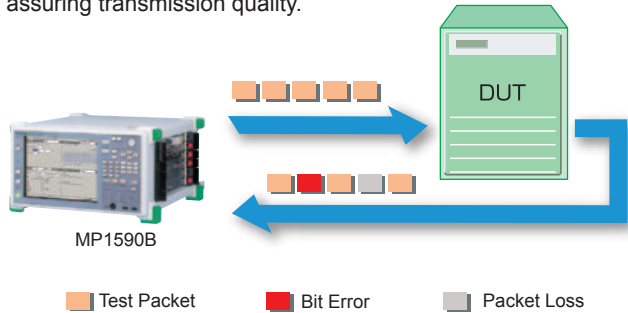

Frequency Measurement

Bit errors and packet loss between equipments are one cause of out-of-specification transfer bit rates (frequencies). This function supports frequency measurement without requiring a dedicated frequency counter.

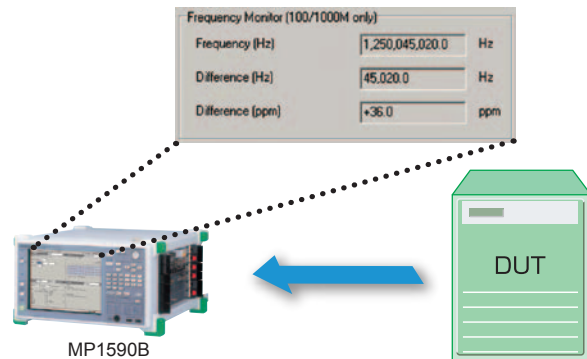

Packet Analysis

Packet Capture

Packet capture is important for analyzing packets when a fault occurs. Powerful packet filtering extracts only the targeted data, which is then saved to internal memory for analysis and display of the packet contents.

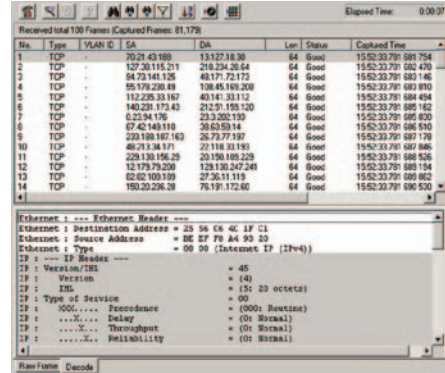

Protocol Decode

The protocol decode function plays a key role in analysis of captured packet. Analysis using both Ethereal® and Wireshark® is supported in addition to the built-in protocol decode functions.

- *: Ethereal® is registered trademarks of Ethereal, Inc.
- *: Wireshark® is registered trademarks of Gerald Combs.

Auto-measurement

RFC2544/RFC2889 Auto-measurement

Switch performance can be measured automatically using the IETF-compliant RFC2544 and RFC2889 tests. The one-touch button operations greatly reduce the time and effort of manual measurements, increasing productivity and efficiency.

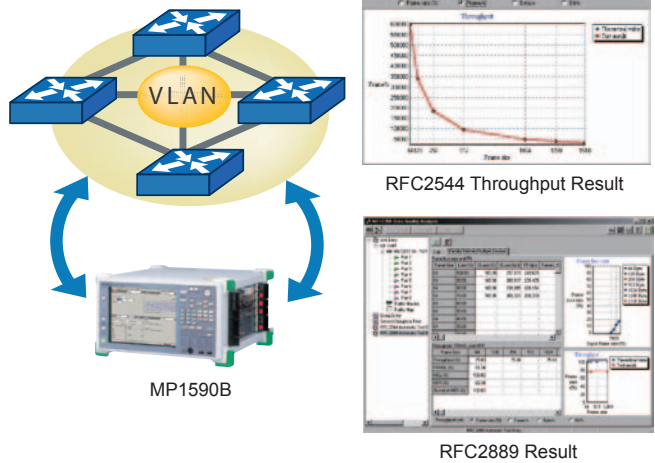



Useful Functions

Remote Control from PC

Installing the MX159001B Control Software Package in PCs allows remote control of these testers using the same GUI. Multi-user support allows up to 8 users to share the Ethernet unit measurement ports. Connecting eight MP1590Bs in a cascade expands the number of slots to 48.

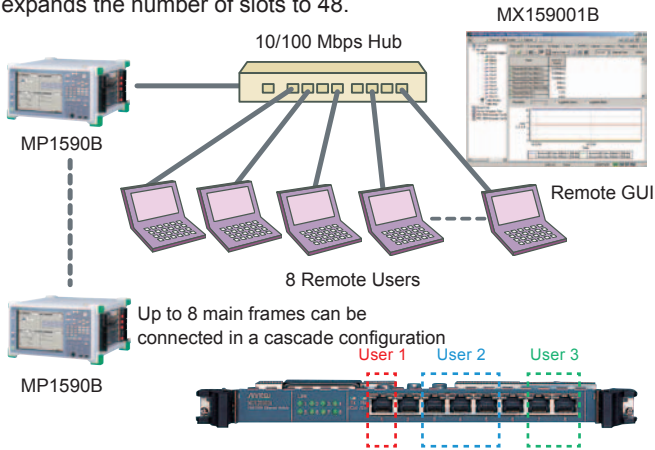

Optical Power Measurement, Optical Attenuation Function

This function measures the average power of the input optical signal when using an optical interface. The optional optical attenuator (Option-04) can attenuate optical output levels up to 30 dB (≤ 2.6 Gbit/s)/20 dB (≥ 9953 Mbit/s).

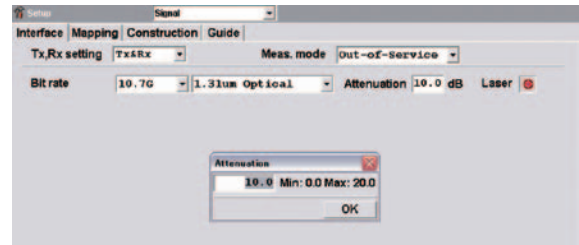

Trigger Output

A received signal can be used as a trigger output to external equipment. The trigger output can be synchronized to the clock output or divided clock output as well as to a frame. For example, linking the trigger output to an external sampling oscilloscope enables the MP1590B to evaluate errors and alarms at the same time the oscilloscope evaluates the waveform.

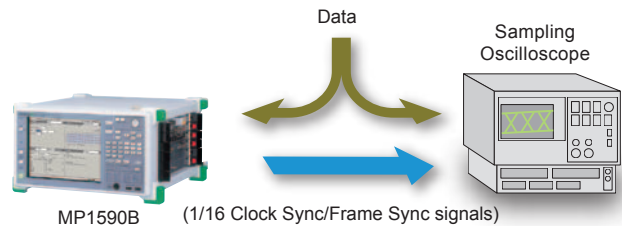

Remote Command Interface

Sending text-based command messages to these testers using the remote command interface provides automated control for creating automatic test applications. The remote command interface supports the RS-232C, GPIB, and Ethernet (Option-01, 02, 03) Interfaces.

Report Function

Reports output in HTML format include the measurement conditions and results with graphs for counters, multiflow counters, latency, RFC2544 and RFC2889. Reports can be saved during measurement by using the pause function.

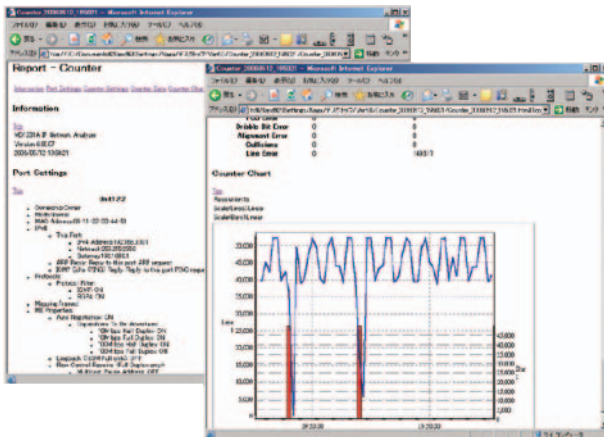



Ethernet Unit Functions

Model	MU120111A	MU120121A	MU120131A	MU120112A	MU120122A	MU120132A	MU120118B/C	MU120138A
Interface	10/100BASE-T	10/100/1000BASE-T		1000BASE-X, T	10/100/1000BASE-T 1000BASE-X	1000BASE-X	10GBASE-R	
Ports (Connector)	8 (RJ-45)	4 (RJ-45)	12 (RJ-45)	2 (GBIC)	2 (RJ-45) 2 (SFP)	8 (SFP)	2 (XENPAK)/ 1 (XENPAK)	4 (SFP+)
Clock Variation		✓	✓*1		✓	✓*1	✓*2	✓*1
Link Flap			✓			✓		✓*3
Auto MDI/MDI-X		✓	✓		✓			
Frame Generation								
Stream Generation (Tx Stream)	✓	✓	✓	✓	✓	✓	✓	✓
Multi-Layer VLAN		✓	✓		✓	✓		✓
MAC Address Increment	✓	✓	✓	✓	✓	✓	✓	✓
IP Address Increment	✓	✓	✓	✓	✓	✓	✓	✓
TCP/UDP Port Number Increment	✓	✓	✓	✓	✓	✓	✓	✓
Test Frame Addition	✓	✓	✓	✓	✓	✓	✓	✓
Hardware Random Pattern		✓	✓		✓	✓	✓	✓
Measurement								
Counter	✓	✓	✓	✓	✓	✓	✓	✓
Multi-Flow Counter		✓*4	✓		✓*4	✓		✓
Capture	✓	✓	✓	✓	✓	✓	✓	✓
Decode	✓	✓	✓	✓	✓	✓	✓	✓
Latency	✓	✓	✓	✓	✓	✓	✓	✓
Ping	✓	✓	✓	✓	✓	✓	✓	✓
Ping6 (Option-12)	✓	✓	✓	✓	✓	✓	✓	✓
Arrival Time Variation/Latency Variation	✓*5	✓	✓	✓*5	✓	✓	✓*5	✓
Through Mode	✓	✓	✓	✓	✓	✓	✓	✓
Monitor Mode	✓	✓	✓	✓	✓	✓	✓	✓
Address Swap Mode	✓	✓	✓	✓	✓	✓	✓	✓
Unframe BER Test	✓	✓	✓	✓	✓	✓	✓*6	✓
Packet BER Test (Option-11)	✓	✓	✓	✓	✓	✓	✓	✓
Auto Negotiation Analysis (Option-15)*7				✓	✓	✓		
Application Traffic Monitor (Option-20)		✓	✓	✓	✓	✓		
Link Fault Signalling (Option-16)							✓	
Link Fault Signalling (Module Option-03)								✓*8
XENPAK Test (Option-13)							✓	
Clock Measurement		✓	✓*1		✓	✓*1		✓*1
PoE (Module Option-02)			✓					
Ethernet OAM (Option-28)	✓*9	✓	✓	✓*9	✓	✓	✓*9	✓
Automatic Test								
RFC2544 with VLAN	✓	✓	✓	✓	✓	✓	✓	✓
RFC2889 with VLAN (Option-10)	✓	✓	✓	✓	✓	✓	✓	✓
Protocol Emulation								
ARP	✓	✓	✓	✓	✓	✓	✓	✓
ICMP	✓	✓	✓	✓	✓	✓	✓	✓
OSPF (Option-07)	✓	✓		✓	✓		✓	
BGP-4	✓	✓		✓	✓		✓	
ICMPv6 (Option-12)	✓	✓	✓	✓	✓	✓	✓	✓
IGMPv2/IGMPv3	✓	✓	✓	✓	✓	✓	✓	✓
IGAP (Option-14)	✓	✓	✓	✓	✓	✓	✓	✓
MLD/MLDv2 (Option-12)	✓	✓	✓	✓	✓	✓	✓	✓
MPLS (LDP/CR-LDP) (Option-08)	✓	✓		✓	✓		✓	
MPLS (RSVP-TE) (Option-09)	✓	✓		✓	✓		✓	
Other								
Traffic Impairment Emulator (Option-17)*4		✓			✓			

*1: Requires MU120131A/32A/38A-01 Clock Measurement option

*2: Requires XENPAK Test (Option-13). However, the variable clock of this unit supports only the XAUI interface.

*3: Excludes No/Go Check

*4: Supported by ports 1 and 2. Electrical ports (10/100/1000BASE-T) for MU120121A and optical ports (1000BASE-X) for MU120122A.

*5: Supports only Arrival Time Variation Measurement

*6: Requires XENPAK Test (Option-13)

*7: Supports SX/LX/LH/ZX for GBIC or SX/LX/LE/LR for SFP

*8: Requires MU120138A-03 Link Fault Signalling option

*9: Supports OAM frame send and protocol analysis of captured frame only



SDH/SONET/OTN/PDH/DSn/10G Ethernet/Jitter/EoS Interface List

Typical Configuration			For SDH/SONET/OTN/PDH/DSn/10G Ethernet/Performance Measurement	For SDH/SONET/OTN/Jitter Measurement				For EoS Measurement	For Ethernet Measurement
Model/Slot Position	MP1590B	Slot 1	MU150110A	MU150110A	MU150110A	MU150110A	MU150101A	MU150101A	Blank
		Slot 2							Blank
		Slot 3	Blank	MU150121A	MU150121B	MU150121B	Blank	Blank	Blank
		Slot 4	Blank	MU150123A	MU150123B	MU150124B	Blank	Blank	Blank
		Slot 5	Blank					Blank	Blank
		Slot 6	Blank	MU150125A	MU150125A	MU150125A	MU150125A	Blank	Blank
Item	Bit Rate	Interface							
Performance Measurement	PDH/DSn	1.5 Mbit/s to 139 Mbit/s	Electrical	✓	✓	✓	✓	✓	
	SDH/SONET	52 Mbit/s to 156 Mbit/s	Electrical • Optical	✓	✓	✓	✓	✓	
		622 Mbit/s to 2488 Mbit/s	Optical	✓	✓	✓	✓	✓	
		9953 Mbit/s	Electrical • Optical	✓	✓	✓	✓		
	OTN	2666 Mbit/s	Optical	✓*1	✓*1	✓*1	✓*1	✓*1	✓*1
		10.7 Gbit/s	Electrical • Optical	✓*1	✓*1	✓*1	✓*1		
		11.04 Gbit/s to 11.09 Gbit/s	Optical	✓*1	✓*1	✓*1	✓*1		
	10G Ethernet	10.3 Gbit/s	Electrical • Optical	✓*1	✓*1	✓*1	✓*1		
			Electrical differential			✓*1	✓*1		
	Ethernet	10 Mbit/s to 10 Gbit/s	Electrical • Optical	✓*2				✓*2	✓*2
EoS	156 Mbit/s to 2488 Mbit/s	Optical					✓*1	✓*1	
Jitter Measurement	PDH/DSn	1.5 Mbit/s to 139 Mbit/s	Electrical						
	SDH/SONET	52 Mbit/s to 156 Mbit/s	Electrical • Optical		✓	✓	✓	✓	
		622 Mbit/s to 2488 Mbit/s	Optical		✓	✓	✓	✓	
		9953 Mbit/s	Electrical • Optical		✓	✓			
	OTN	2666 Mbit/s	Optical		✓*1	✓*1	✓*1	✓*1	
		10.7 Gbit/s	Electrical • Optical		✓*1	✓*1			
		11.04 Gbit/s to 11.09 Gbit/s	Optical						
	10G Ethernet	10.3 Gbit/s*3	Electrical • Optical				✓*1		
			Electrical differential				✓*1		

*1: Requires addition of separate option.

*2: Supports installation of Ethernet units in blank slots but with restrictions on position and number. See page 16 of the Selection guide for more details.

*3: 10.3 Gbit/s jitter measurement supports only No Frame.

Supported Mappings

OTN Mappings

OTU2 (10.71 Gbit/s) Mapping structure

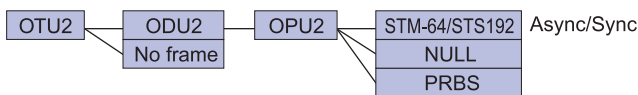

OTU1 (2.66 Gbit/s) Mapping structure

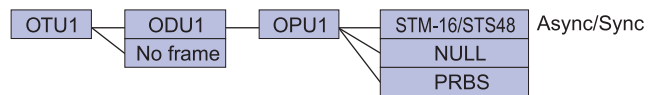

OTU2e (11.09 Gbit/s) Mapping structure

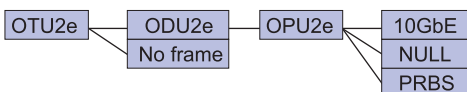

OTU1e (11.04 Gbit/s) Mapping structure

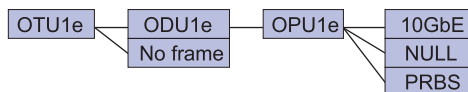

10G Ethernet Mapping

10.3G Mapping structure

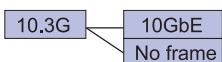

SDH Mappings

SDH Mapping structure

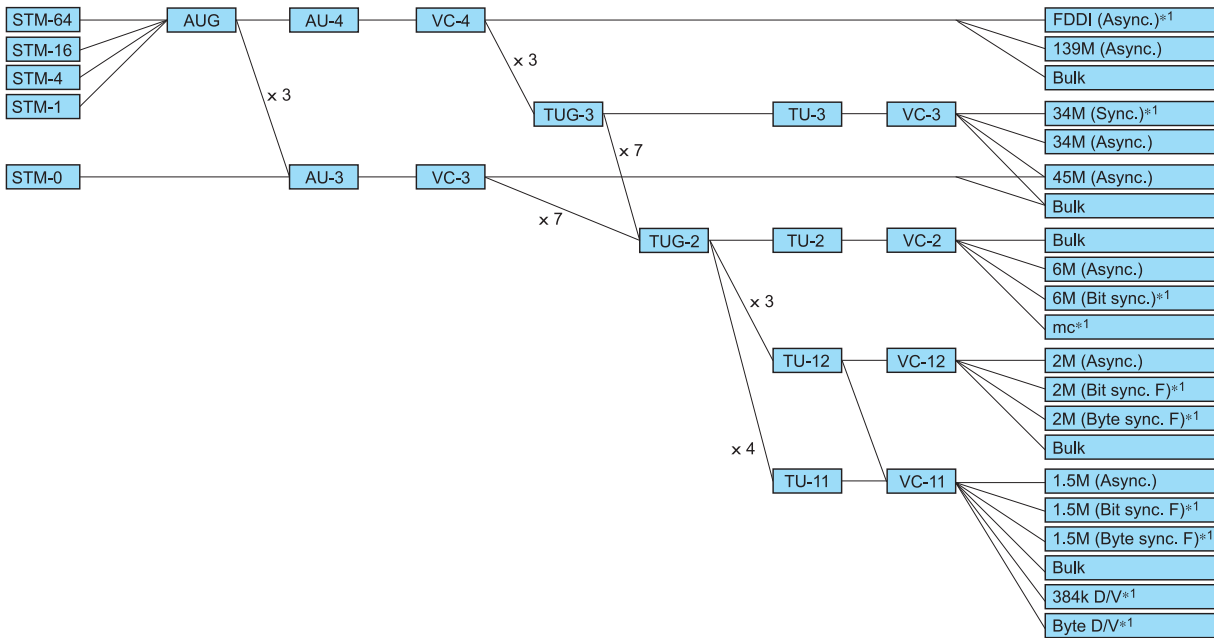

SDH Concatenation mapping structure

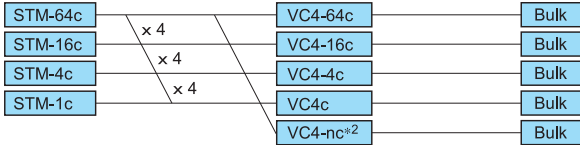

SDH Virtual concatenation mapping structure

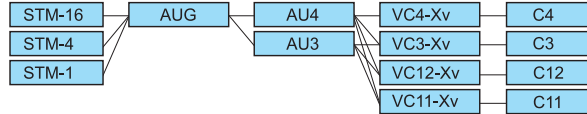

SONET Mappings

SONET Mapping structure

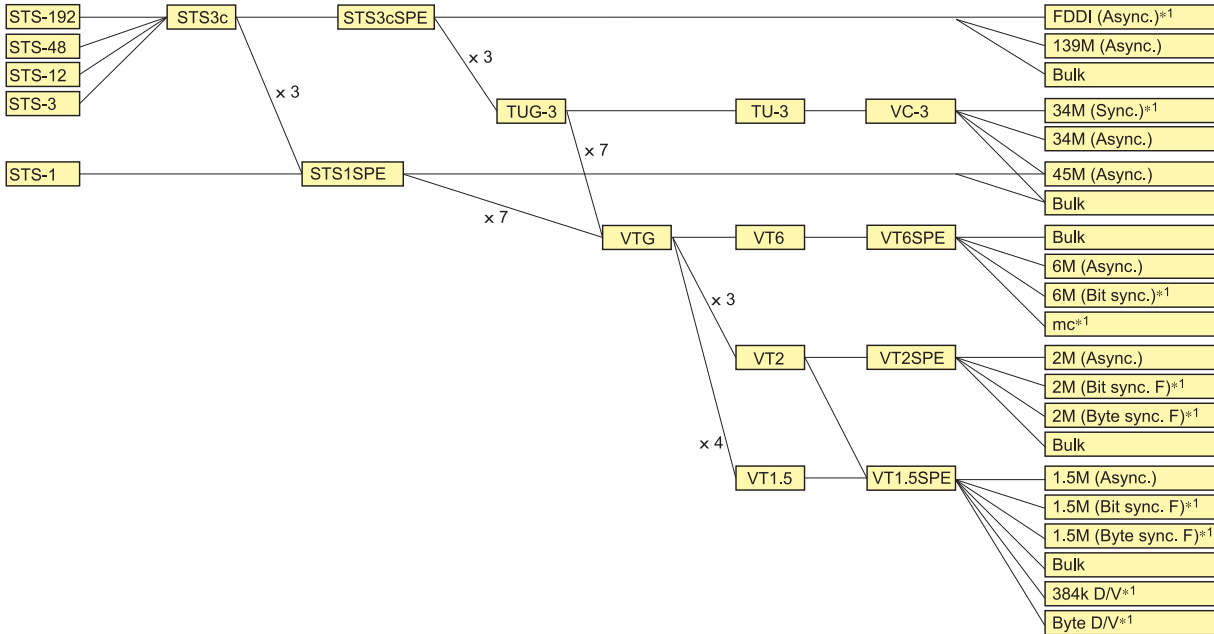

SONET Concatenation mapping structure

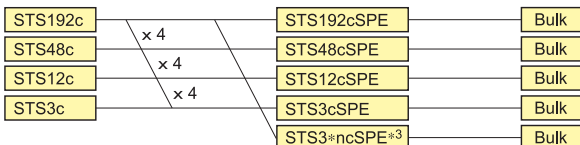

SONET Virtual concatenation mapping structure

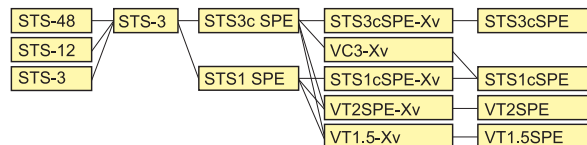

*1: Not supported in multichannel mode

*2: The maximum value of n is 16. However, this value is 8 in the multichannel mode. Links cannot be made across the following groups.
 AUG#1 to AUG#8, AUG#9 to AUG#16, AUG#17 to AUG#24,
 AUG#25 to AUG#32, AUG#33 to AUG#40, AUG#41 to AUG#48,
 AUG#49 to AUG#56, AUG#57 to AUG#64

*3: The maximum value of n is 16. However, this value is 8 in the multichannel mode. Links cannot be made across the following groups.
 STS3c#1 to STS3c#8, STS3c#9 to STS3c#16, STS3c#17 to STS3c#24,
 STS3c#25 to STS3c#32, STS3c#33 to STS3c#40, STS3c#41 to STS3c#48,
 STS3c#49 to STS3c#56, STS3c#57 to STS3c#64



Selection Guide

Unit Insertion Positions

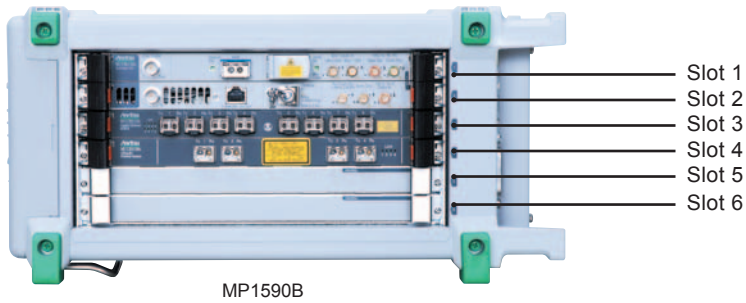

Plug-in Unit Insertion Table

Model/Order No.	Module Name	No. of Slots Required	No. of Ports	Max. No. Modules	Supported Slots	Current Consumption (A)*1
MU120111A	10/100M Ethernet Module	1	8	4	3 to 6	5.5
MU120112A	Gigabit Ethernet Module	1	2	4	3 to 6	5.5
MU120121A	10/100/1000M Ethernet Module	1	4	2	3 to 6	19
MU120122A	Gigabit Ethernet Module	1	4	2	3 to 6	19
MU120131A	10/100/1000M Ethernet Module	1	12	2	3 to 6	15
MU120132A	Gigabit Ethernet Module	1	8	2	3 to 6	13
MU120118B	10 Gigabit Ethernet Module	2	2	1	4 to 6	19
MU120118C	10 Gigabit Ethernet Module	2	1	1	4 to 6	10
MU120138A	10 Gigabit Ethernet Module	1	4	3	3 to 6	11
MU150110A	Multirate Unit	2	-	1	1 to 2	10
MU150101A	2.5/2.6G EoS Unit	2		1	1 to 2	7
MU150121A	10/10.7G Optical Unit (Tx)	1		1	3	0.5
MU150121B	10/10.7G Optical/Electrical Unit (Tx)	1		1	3	0.5
MU150123A	10/10.7G Optical Unit (Rx Wide)	1		1	4	0.5
MU150123B	10/10.7G Optical/Electrical Unit (Rx Wide)	1		1	4	0.5
MU150124B	10.3G Optical/Electrical Unit (Rx Wide)	1		1	4	0.5
MU150125A	10/10.7G Jitter Unit	2		1	5 to 6	2

*1: Ensure that the total current consumption for all plug-in units inserted in the MP1590B does not exceed 38 A.

■ MP1590B Main Frame Options

Name	Model/Order No.
RS-232C Control	MP1590B-01
GPIB Control	MP1590B-02
Ethernet Control	MP1590B-03
OSPF Protocol	MP1590B-07
MPLS (LDP/CR-LDP) Protocol	MP1590B-08
MPLS (RSVP) Protocol	MP1590B-09
RFC2889 Benchmarking Test	MP1590B-10
Packet BER Test	MP1590B-11
IPv6 Expansion	MP1590B-12
XENPAK Test	MP1590B-13
IGAP Protocol	MP1590B-14
Auto Negotiation Analysis	MP1590B-15
Link Fault Signalling*1	MP1590B-16
Traffic Impairment Emulator	MP1590B-17
Application Traffic Monitor	MP1590B-20
Ethernet OAM	MP1590B-28
High Precision Jitter Analysis	MP1590B-30

*1: This option is for the MU120118B/C 10 Gigabit Ethernet Module.
Choose the MU120138A-03 when using the Link Fault Signalling option for the MU120138A 10 Gigabit Ethernet Module.

■ Plug-in Unit Options

	Model/Order No.	Name	MU120131A	MU120132A	MU120138A	MU150110A	MU150101A	MU150121A/21B	MU150123A/23B	MU150124B	MU150125A
Ethernet Unit	MU120131A/32A/38A-01	Clock Measurement	✓	✓	✓						
	MU120131A-02	PoE	✓								
	MU120138A-03	Link Fault Signalling*1			✓						
SDH/SONET/ OTN/PDH/DSn/ Jitter/EoS Unit	MU150101A/21A/21B-01	Wave length 1.31 μm					✓	✓			
	MU150101A/21A/21B-02	Wave length 1.55 μm					✓	✓			
	MU150101A/21A/21B-03	Wave length 1.31/1.55 μm					✓	✓			
	MU150110A-004, MU150101A/21A/21B-04	Optical Output Power Adjustable				✓	✓	✓			
	MU150110A-005, MU150125A-05	OTU1/OTU2				✓					✓
	MU150101A-05	OTU1					✓				
	MU150123A/23B-05	OTU2							✓		
	MU150110A-006	11.1G				✓					
	MU150101A-06	GFP-F/LEX/LAPS					✓				
	MU150101A-07	POS					✓				
	MU150101A-11	HO Virtual Concatenation					✓				
	MU150101A-12	LO Virtual Concatenation					✓				
	MU150101A-13	LCAS					✓				
	MU150101A-14	Differential Delay					✓				
	MU150125A-01	Wander Measurement									✓
	MU150110A-008, MU150125A-06	10.3G				✓					✓
	MU150110A-009	Insert/Extract				✓					
	MU150110A-010	Multichannel Measurement				✓					
	MU150110A/01A/21A/21B/23A/23B/24B-38	ST Connector				✓	✓	✓	✓	✓	✓
	MU150110A/01A/21A/21B/23A/23B/24B-39	DIN Connector				✓	✓	✓	✓	✓	✓
MU150110A/01A/21A/21B/23A/23B/24B-40	SC Connector				✓	✓	✓	✓	✓	✓	
MU150110A/01A/21A/21B/23A/23B/24B-43	HMS-10/A Connector				✓	✓	✓	✓	✓	✓	

*: Order additional J1349A when Ethernet unit installed simultaneously in SDH/SONET/OTN/PDH/DSn unit and jitter unit configurations.

*1: This option is for the MU120138A 10 Gigabit Ethernet Module.
Choose the MP1590B-16 when using the Link Fault Signalling option for the MU120118B/C 10 Gigabit Ethernet Module.



MP1590B Network Performance Tester

*: Refer to the MD1230 Family Catalog for specifications related to Ethernet Plug-in Units.

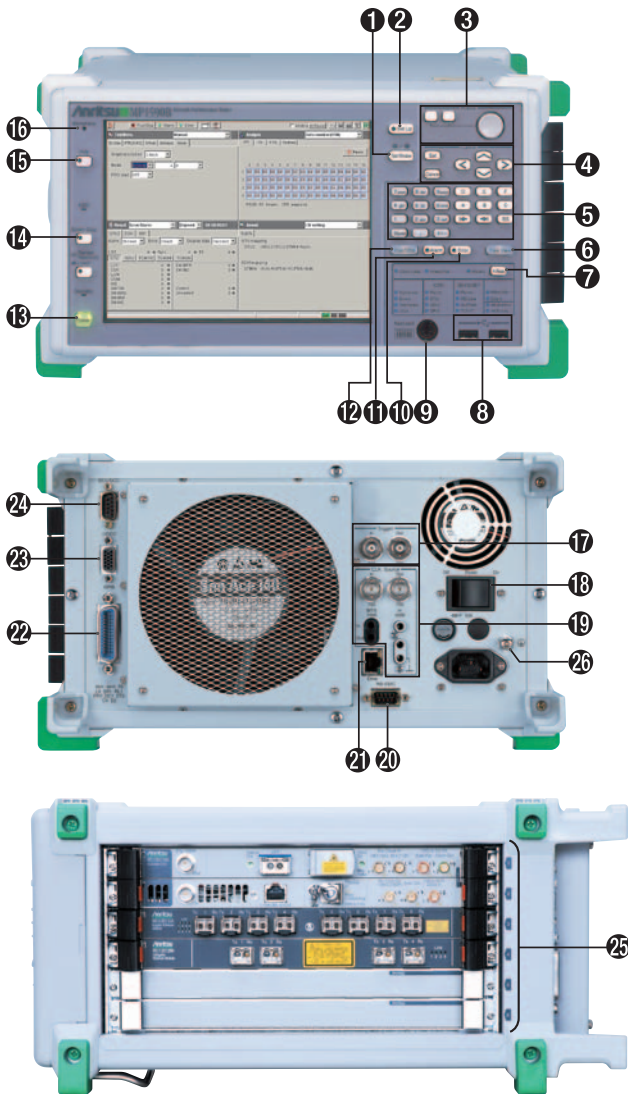

1	Test Window	Switches between one screen and four split screens
2	Set Up	Switches between Setup window and Test Window
3	Pointer	Performs same operation as mouse
4	Cursor	Set: Sets data Cancel: Deletes set data <> < >: Move cursor around screen
5	Input Keys	Input numeric values and data
6	Tree View	Toggles Tree View area display on/off
7	H.Reset	Resets history data
8	USB (2 Ports)	Connects USB devices
9	Keyboard	Connects PS/2 keyboard
10	Error	Starts/Stops error addition
11	Alarm	Starts/Stops alarm addition
12	Run/Stop	Starts/Stops measurement
13	Power	When Power lamp lit, quits MP1590B application and returns to Standby status When in Standby status (Standby lamp lit), launches MP1590B application
14	Screen Copy	Copies screen contents
15	Help	Displays Help screen
16	Microphone	Microphone for order wire
17	Trigger	Input: Connector for inputting external trigger for running APS test and capture Output: Connector for outputting errors/alarms and capture trigger
18	Power (main)	Switches main power on and off
19	CLK Source	Input: Connector for inputting reference signal for syncing Tx signal to reference signal Output: Connector for outputting reference signal synchronized to Tx signal
20	RS-232C	RS-232C interface connector
21	Ethernet	10BASE-T/100BASE-TX Ethernet connector for remote control.
22	GPIB	GPIB interface connector
23	VIDEO	VGA connector for external display
24	DCC/GCC	I/O connector for DCC (SDH/SONET) and GCC (OTN) bytes, and for data and clock for add/drop
25	Plug-in slot	Slot for plug-in unit
26	Functional Ground Terminal	Terminal for grounding frame to earth



Specifications

• MP1590B Network Performance Tester

Indicator	LCD	8.4", Color TFT, SVGA (800 × 600)	
	LED	OTN: Frame, OTU, ODU, OPU SDH/SONET: Frame, MS/Line, AU/Path, TU/VT Other: Standby, HDD, Clock Loss, Power Fail, History, Signal Loss, Errors, Test Pattern, Jitter, PDH/DSn, Event, All Errors, All Alarms	
OS		Windows® XP Professional	
Storage Unit		HDD	
RS-232C, GPIB, Ethernet (RJ-45), USB1.1 × 2 ports, Keyboard (PS/2), VGA (15-pin mini D-sub)			
Interface	Reference Clock Input	<p>Frequency</p> <p>Clock: 1.544 MHz, 2.048 MHz, 64 kHz + 8 kHz, 5 MHz, 10 MHz</p> <p>Data: 1.544 Mbit/s (BITS), 2.048 Mbit/s</p> <p>Input Range: ±50 ppm</p> <p>Level/Code</p> <p>1.544 Mbit/s: ANSI T1.403 (B8ZS)</p> <p>2.048 Mbit/s: ITU-T G.703 Table 10 (HDB3)</p> <p>1.544 MHz, 2.048 MHz, 5 MHz, 10 MHz: TTL (Rectangular, Sine Wave)</p> <p>64 kHz + 8 kHz: 0.63 to 1.1 Vo-p (AMI, 8 kHz violation)</p>	<p>Connector</p> <p>1.544 MHz, 2.048 MHz, 2.048 Mbit/s, 5 MHz, 10 MHz: BNC (75 Ω)</p> <p>2.048 MHz, 2.048 Mbit/s, 64 kHz + 8 kHz: Siemens (120 Ω)</p> <p>1.544 Mbit/s: BANTAM (100 Ω)</p> <p>Effective SDH/SONET/OTN Bit Rate.</p>
	Reference Clock Output	<p>Frequency</p> <p>Clock: 1.544 MHz, 2.048 MHz, 5 MHz, 10 MHz</p> <p>Data: 1.544 Mbit/s (BITS), 2.048 Mbit/s</p> <p>Level/Code</p> <p>1.544 Mbit/s: ANSI T1.403 (B8ZS)</p> <p>2.048 Mbit/s: ITU-T G.703 Table 10 (HDB3)</p> <p>1.544 MHz, 2.048 MHz, 5 MHz, 10 MHz: TTL (Rectangular)</p>	<p>Connector</p> <p>1.544 MHz, 2.048 MHz, 2.048 Mbit/s, 5 MHz, 10 MHz: BNC (75 Ω)</p> <p>1.544 Mbit/s: BANTAM (100 Ω)</p> <p>Effective SDH/SONET/OTN Bit Rate.</p>
	Trigger	<p>Trigger Input: For capture/APS Measurement</p> <p>Trigger Output: Transmit error/alarm, Receive error/alarm, Capture trigger</p>	<p>Level: TTL (Active High)</p> <p>Connector: BNC (75 Ω)</p>
	DCC/GCC	<p>Data Input/Output: D1-D3 (192 kbit/s), D4-D12 (576 kbit/s), GCC0-2 (1312.4 kbit/s, 326.7 kbit/s)</p> <p>Clock Output: 192 kHz, 576 kHz, 1312.4 kHz, 326.7 kHz</p> <p>Level: V.11</p> <p>Connector: 9-pin D-sub</p>	
Remote Control		<p>Remote control using MX159001B via LAN (10BASE-T/100BASE-TX)</p> <p>In addition, remote command control supported using any of GPIB (Option-02), LAN (Option-03), RS-232C (Option-01)</p>	
Input Device		Pointing device, front keys	
Power		100 V(ac) to 120 V(ac)/200 V(ac) to 240 V(ac) (autoswitching), 50 Hz to 60 Hz	
Power Consumption		≤500 VA	
Operational Temperature and Humidity		5° to 40°C, 20 to 80%	
Dimensions and Mass		320 (W) × 177 (H) × 350 (D) mm, ≤13 kg (excluding options and plug-in units)	
EMC		EN61326-1, EN61000-3-2	
LVD		EN61010-1	
Laser Safety		Depends on installed module. Refer to the safety standards for each module.	
Number of Slots		6	

• MP1590B-30 High Precision Jitter Analysis

Overview	Option for performing calibration of main frame using Phase Analysis calibration method outlined in ITU-T O.172 2005 April Appendix VIII standard with following specifications
Jitter Generation Measurement Accuracy	Accuracy: ± 20 mUIp-p (Approaches transmitter jitter (≤ 100 mUIp-p) standardized by phase analysis calibration method) Bit Rate: 9953.28 Mbit/s Interface: Optical Measurement Condition Optical Input Power: -12 to -10 dBm Measurement Period: 60 s/1 time Measurement Method: phase analysis calibration method (Appendix VIII) Accuracy Calculation: Measured 5 times at 60 s/time to calculate mean of measurement results Mean value accuracy of ± 20 mUIp-p for Tx jitter of 100 mUIp-p max. standardized by phase analysis method Filters: 20 kHz to 80 MHz/50 kHz to 80 MHz (9953 M) Tx Unit: MU150121A/B (9953 M) Frame: Appendix VIII compliant (margin reference format)
Jitter Generation Measurement Repeatability	Accuracy: ± 5 mUIp-p (Average of five measurements under constant measurement condition) Bit Rate: 9953.28 Mbit/s Interface: Optical Measurement Condition Optical Input Power: -12 to -10 dBm Measurement Period: 60 s/1 time Measurement Method: Loop-back Filters: 20 kHz to 80 MHz, 50 kHz to 80 MHz/4 MHz to 80 MHz (9953 M) Tx Unit: MU150121A/B (9953 M) Mapping: STS192c/STM-64c-Bulk (PRBS $2^{23} - 1$ Inv.) (9953 M)
Transmitter Output Jitter	Jitter Value: < 60 mUIp-p (MU150121A/B) Bit Rate: 9953.28 Mbit/s Interface: Optical Measurement Condition Measurement Method: Phase analysis calibration method (Appendix VIII) Accuracy Calculation: Mean of three measurements Filters: 20 kHz to 80 MHz/50 kHz to 80 MHz (9953 M) Tx Unit: MU150121A/B (9953 M) Sampling Oscilloscope: > 20 GHz bandwidth Frame: Appendix VIII compliant (margin reference format)
General Specification	Operating Temperature: 20° to 30° C Recommended Calibration Interval: 1 year after shipment and annually thereafter

Precautions for Option-30

This option can only be installed in the following configurations. Other combinations cannot be installed. (The MU150101A is not supported.)
 This option is managed by equipment model and serial number. Accordingly, if it is installed in a unit with the same model number but different serial number, it will be disabled. When changing to a configuration that is different from the configuration with the option installed, the MP1590B functions and performance operate normally based on the switched configuration.

- MP1590B: Network Performance Tester
- MU150110A: Multirate Unit
- MU150121A/B: 10/10.7G Optical (/Electrical) Transmitter Unit (Install either one.)
- MU150123A/B: 10/10.7G Optical (/Electrical) Receiver Unit (Wide) (Install either one.)
- MU150125A: 10/10.7G Jitter Unit

The Transmission Output Jitter is specified in the certificate attached to the option.
 The recommended calibration interval for Option-30 is 1 year after shipment and annually thereafter.

Frame Format

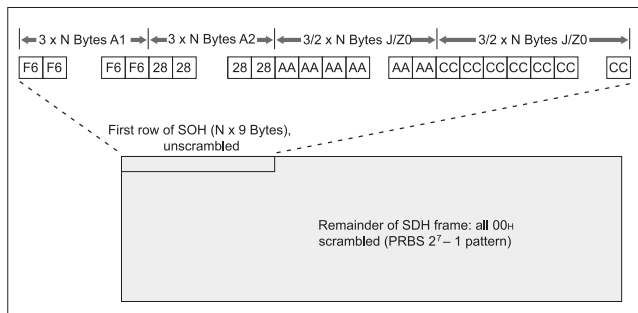

- MU150110A Multirate Unit
- MU150101A 2.5/2.6G EoS Unit

Model	MU150110A	MU150101A*1
Electrical Interface (1.544 Mbit/s to 155.52 Mbit/s)	Bit Rate PDH/DSn: 1.544 Mbit/s, 2.048 Mbit/s, 8.448 Mbit/s, 34.368 Mbit/s, 44.736 Mbit/s, 139.264 Mbit/s SDH/SONET: 51.84 Mbit/s, 155.52 Mbit/s Code 1.544 Mbit/s: AMI/B8ZS 2.048 Mbit/s, 8.448 Mbit/s, 34.368 Mbit/s: HDB3 44.736 Mbit/s, 51.84 Mbit/s: B3ZS 139.264 Mbit/s, 155.52 Mbit/s: CMI	
	Connector 1.544 Mbit/s: RJ-45 100 Ω Balanced 2.048 Mbit/s: RJ-45 120 Ω Balanced 2.048 Mbit/s, 8.448 Mbit/s, 34.368 Mbit/s, 44.736 Mbit/s, 51.84 Mbit/s, 139.264 Mbit/s, 155.52 Mbit/s: BNC 75 Ω	Connector 1.544 Mbit/s: BANTAM 100 Ω Balanced 2.048 Mbit/s: 3 pin Siemens 120 Ω Balanced 2.048 Mbit/s, 8.448 Mbit/s, 34.368 Mbit/s, 44.736 Mbit/s, 51.84 Mbit/s, 139.264 Mbit/s, 155.52 Mbit/s: BNC 75 Ω
	Level ANSI T1.102 (1.544 Mbit/s, 44.736 Mbit/s) ITU-T G.703 (2.048 Mbit/s, 8.448 Mbit/s, 34.368 Mbit/s, 139.264 Mbit/s) DSX Output (1.544 Mbit/s): 0/655 feet DSX Output (44.736 Mbit/s, 51.84 Mbit/s): 0/450/900 feet Monitor Gain 20 dB, 26 dB: 1.544 Mbit/s, 2.048 Mbit/s, 8.448 Mbit/s, 34.368 Mbit/s, 44.736 Mbit/s, 51.84 Mbit/s 20 dB: 139.264 Mbit/s, 155.52 Mbit/s	

Model	MU150110A	MU150101A*1
Electrical Interface (9953.28 M, 10312.5 M, 10709.225 Mbit/s)	Bit Rate SDH/SONET: 9953.28 Mbit/s 10.3 G: 10312.5 Mbit/s (Option-008 installed) OTN: 10709.225 Mbit/s (Option-005 installed) Code: NRZ Connector: SMA 50Ω Level Clock Output: 0.6 to 1.3 Vp-p Data Output: -0.2 to 0 V (High), -1.5 to -0.85 V (Low) Data Input: 0.3 to 1.5 Vp-p	—
Optical Interface (51.84 Mbit/s to 2666.057 Mbit/s)	Bit Rate SDH/SONET: 51.84 Mbit/s, 155.52 Mbit/s, 622.08 Mbit/s, 2488.32 Mbit/s OTN: 2666.057 Mbit/s (Option-005 installed) Code: NRZ Connector: FC-PC (SMF), Replaceable	
Optical Output (51.84 Mbit/s to 2666.057 Mbit/s)*4	Level: -1 to +3 dBm (ATT = 0 dB, Option-04/004) Extinction Ratio: ≥10 dB SMSR: ≥30 dB Peak Wavelength: 1550 nm ±20 nm (Option-02, 03 for MU150101A), 1310 nm ±20 nm (Option-01, 03 for MU150101A) Spectrum Width: ≤1 nm (@ -20 dB)	
Optical Input (51.84 Mbit/s to 2666.057 Mbit/s)	Optical Input Level: -33 to -8 dBm (51.84 Mbit/s, 155.52 Mbit/s), -29 to -8 dBm (622.08 Mbit/s, 2488.32 Mbit/s, 2666.057 Mbit/s) Wavelength: 1260 nm to 1610 nm Overload: +3 dBm (average)	
Optical Interface (9953.28 Mbit/s to 11095.727 Mbit/s)	Bit Rate SDH/SONET: 9953.28 Mbit/s 10.3G: 10312.5 Mbit/s (Option-008 installed) OTN: 10709.225 Mbit/s (Option-005 installed) 11049.107 Mbit/s (Option-006 installed) 11095.727 Mbit/s (Option-006 installed) Code: NRZ Connector: LC-PC (XFP module)	—
Optical Output (9953.28 Mbit/s to 11095.727 Mbit/s)	G0194A 1310 nm XFP Module Level: -6 to -1 dBm Extinction Ratio: ≥6 dB SMSR: ≥30 dB Peak Wavelength: 1290 nm to 1330 nm (1310 nm typ.) Spectrum Width: ≤1 nm (@ -20 dB)	—
	G0195A 1550 nm XFP Module Level: -1 to +2 dBm Extinction Ratio: ≥8.2 dB SMSR: ≥30 dB Peak Wavelength: 1530 nm to 1565 nm (1550 nm typ.) Spectrum Width: ≤1 nm (@ -20 dB)	
Optical Input (9953.28 Mbit/s to 11095.727 Mbit/s)	G0194A 1310 nm XFP Module Sensitivity: -11 dBm (9953.28 Mbit/s, 10709.225 Mbit/s), -10.3 dBm (10312.5 Mbit/s, 11049.107 Mbit/s, 11095.727 Mbit/s) Wavelength: 1260 nm to 1355 nm Absolute Maximum Optical Input: +0.5 dBm (average)	—
	G0195A 1550 nm XFP Module Sensitivity: -14 dBm (9953.28 Mbit/s, 10709.225 Mbit/s), -11.3 dBm (10312.5 Mbit/s, 11049.107 Mbit/s, 11095.727 Mbit/s) Wavelength: 1260 nm to 1580 nm Absolute Maximum Optical Input: -1 dBm (average)	
Clock	Internal, External (Reference Input, 1/1 Input), Receive Internal Accuracy: ±0.1 ppm (After power-on, calibrated after 24 hours, warm-up at 23° ±5°C, aging rate (Max.): ±0.05 ppm/day, ±0.5 ppm/year) Offset Range: ±100 ppm/0.1 ppm step	
Frame	1.544 Mbit/s: D4/ESF/Japan ESF 2.048 Mbit/s: 30, 31ch with or without CRC4 8.448 Mbit/s: G.742 34.368 Mbit/s: G.751 44.736 Mbit/s: M13/C-bit 139.264 Mbit/s: G.751	51.84 Mbit/s: SDH/SONET 155.52 Mbit/s: SDH/SONET 622.08 Mbit/s: SDH/SONET 2488.32 Mbit/s: SDH/SONET 9953.28 Mbit/s: SDH/SONET*2
No Frame	1.544, 2.048, 8.448, 34.368, 44.736, 139.264 Mbit/s 51.84, 155.52, 622.08, 2488.32, 9953.28*2 Mbit/s	
Test Pattern	PRBS, Word, All 0, All 1, 3 in 24 (1.544 Mbit/s only) PRBS (SDH/SONET) No Frame: 2 ¹⁵ - 1 (51.84 Mbit/s, 155.52 Mbit/s only), 2 ²³ - 1, 2 ³¹ - 1 Concatenation Mapping: 2 ¹⁵ - 1 (1c/4c), 2 ²³ - 1, 2 ³¹ - 1 Other Mapping: 2 ¹¹ - 1, 2 ¹⁵ - 1, 2 ²⁰ - 1, 2 ²⁰ - 1z (1.5M/45M only), 2 ²³ - 1 Invert On/Off PRBS (PDH/DSn) 2 ¹¹ - 1, 2 ¹⁵ - 1, 2 ²⁰ - 1, 2 ²⁰ - 1z (1.544 Mbit/s, 44.736 Mbit/s only), 2 ²³ - 1 Invert On/Off Word: 16-bit Programmable (Mark Ratio 1/2 at No Frame) Transmit/Receive: Independent setup supported	
Overhead Preset	SOH/TOH/POH: All Bytes (except Parity Byte, K1/K2 Byte and H1/H2/H3 Byte) Dummy Channel POH: All Bytes (except Parity Byte)	

Model	MU150110A	MU150101A*1
Error Addition/ Measurement	PDH/DSn: Bit All (Only Addition), Code, Bit Info, Bit 1.5M, Bit 2M, Bit 8M, Bit 34M, Bit 45M, Bit 139M, FAS 1.5M, FAS 2M, FAS 8M, FAS 34M, FAS 45M, FAS 139M, EXZ, CRC6, Ebit, Parity, Cbit, REI SDH: FAS, Frame (Measurement only), B1, B2, HP-B3, LP-B3, BIP-2, MS-REI (M0/M1), HP-REI, LP-REI, Bit All (Only Addition), Bit Info, OH Bit, HP-IEC, LP-IEC, N2 BIP-2, HP-TC-REI, LP-TC-REI, HP-OEI, LP-OEI SONET: FAS, Frame (Measurement only), B1, B2, HP-B3, LP-B3, BIP-2, REI-L (M0/M1), REI-P, REI-V, Bit All (Only Addition), Bit Info, OH Bit, HP-IEC, LP-IEC, N2 BIP-2, HP-TC-REI, LP-TC-REI, HP-OEI, LP-OEI	
Error Addition Timing	Rate, Alternative, Single, Burst, All, Frame Rate Fix Rate: 1×10^{-n} (n: 3 to 9), User Program: $A \times 10^{-B}$ (A: 0.1 to 9.9, step 0.1, B: 2 to 10) Alternative Error Frame: 0 to 64000, Normal Frame: 1 to 64000 Frame (only at PDH/DSn): Insert n Error Frames (n: 1 to 4) in 16 frames Specify insertion bit position at B1, B2, B3, BIP-2 error insertion	
Alarm Addition/ Measurement	PDH/DSn: LOS, LOF, AIS, RDI, RDI (MF) SDH: LOS, Generic-AIS (Measurement only)*2, LOF, OOF (Measurement only), RS-TIM, MS-AIS, MS-RDI, AU-AIS, AU-LOP, HP-RDI, HP-ERDIP, HP-ERDIS, HP-ERDIC, HP-TIM, HP-UNEQ, HP-SLM, TU-AIS, TU-LOP, TU-LOM, LP-RDI, LP-ERDIP, LP-ERDIS, LP-ERDIC, ISF, LP-RFI, LP-TIM, LP-UNEQ, LP-SLM, Sync., OH Sync., HP-VC-AIS, LP-VC-AIS, HP-FAS, LP-FAS, HP-Incoming AIS, LP-Incoming AIS, HP-TC-RDI, LP-TC-RDI, HP-ODI, LP-ODI, HP-TC-TIM, LP-TC-TIM, HP-LTC, LP-LTC SONET: LOS, Generic-AIS (Measurement only)*2, LOF, OOF (Measurement only), RS-TIM, AIS-L, RDI-L, AIS-P, LOP-P, RDI-P, ERDIP-P, ERDIS-P, ERDIC-P, TIM-P, UNEQ-P, PLM-P, AIS-V, LOP-V, LOM-V, RDI-V, ERDIP-V, ERDIS-V, ERDIC-V, ISF, RFI-V, TIM-V, UNEQ-V, PLM-V, Sync., OH Sync., HP-VC-AIS, LP-VC-AIS, HP-FAS, LP-FAS, HP-Incoming AIS, LP-Incoming AIS, HP-TC-RDI, LP-TC-RDI, HP-ODI, LP-ODI, HP-TC-TIM, LP-TCTIM, HP-LTC, LP-LTC	
Alarm Addition Timing	Single, Burst, Alternative, All Alternative Error Frame = 0 to 64000, Normal Frame = 1 to 64000	
Monitor	PDH/DSn: FAS 1.5M, FW 2M, NFW 2M, MFW 2M, FAS 8M, FAS 34M, FAS 45M, FAS 139M, Info Byte (2M only) SDH/SONET: SOH/TOH/POH, Path Trace, Tandem Byte, K1/K2 Byte, AU/STS, TU/VT Pointer, Payload	
Through	Transparent, Overhead Overwrite (SDH/SONET/OTN only)	
MUX/DEMUX	MUX/DEMUX supported to 64 k units in PDH and DSn	
Add/Drop	PDH/DSn signal added to or dropped from SDH/SONET mapping Bit Rate: 1.5 Mbit/s, 2 Mbit/s, 34 Mbit/s, 45 Mbit/s, 139 Mbit/s STM-0/1/4/16 or OC-1/3/12/48 signal added to or dropped from STM-64 or OC-192 signal (Option-009 installed)*2	
Delay Measurement	Measurement Period: 0.5, 1, 2, 5, 10 s Measurement Range: 0 to 999 μ s (1 μ s step), 1.0 ms to 999.9 ms (0.1 ms step), 1.0 s to 10.0 s (0.1 s step), >Time Out	
Dummy Channel	Mode: Copy/Dummy Dummy Pattern: All 0, All 1, PRBS 2 ¹¹ - 1, PRBS 2 ¹⁵ - 1 (Invert)	
Path Trace	J0, J1, J2 Byte set arbitrarily 16 bytes (CRC On), 64 bytes (CRC Off, J1 only)	
Tandem Connection	N1/Z5, N2 Byte set arbitrarily Set On/Off	
Pointer Generation	AU/STS, TU/VT Pointer Action: NDF, \pm PJ (Pointer Justification), Inc./Dec. PJC Timing: Manual, Burst (2 to 64), Inc./Dec. Timing: 4 to 8000 Frames	
Pointer Measurement	AU/STS, TU/VT Pointer, C Bit Measurement Item: NDF, + PJC, -PJC, Cons, C, C1/C2	
Payload Offset	Offset Range: \pm 100 ppm/0.1 ppm step set at Async Mapping	
APS Test	Switching Time Measurement Measurement Time: 0.1 ms to 2000.0 ms, Timeout (exclude Time for Frame/Pointer Synchronization) APS Sequence Generator Generator Timing: 2 to 64 words, Max. 8000 frames/words Set for K1/K2, K3, K4 Byte	
Overhead Sequence Capture	Capture Byte: K1/K2, K3, K4, AU/STS Pointer, TU/VT Pointer Size: 64 Sequence Repeat: Max. 8000 Frame/Sequence	
Overhead Test	SOH/TOH/POH 1 Byte, A1/A2, K1/K2, RSOH, MSOH, SOH, POH (except Parity Byte, K1/K2 Byte and H1/H2/H3 Byte) Timing: Alternative (A: 1 to 8000 Times, B: 1 to 8000 Times), A and B can be set up to 256 frames.	
Overhead BERT Test	Test Byte: SOH/TOH/POH 1 Byte, D1-D3, D4-D12 (except Parity Byte, K1/K2 Byte and H1/H2/H3 Byte) Pattern: PRBS 2 ¹¹ - 1, PRBS 2 ¹⁵ - 1 (Invert) Error Addition: Bit (Only Single) Measurement: Bit Error, Sync Loss	
Overhead Add/Drop	Test Byte: D1-D3, D4-D12	
Error Performance	G.821, G.826, G.828, G.829, M.2100, M.2101, M.2110, M.2120, GR.820	
Optical Power Meter	51.84 Mbit/s to 2666.057 Mbit/s Wavelength: 1310 nm/1550 nm Measurement Range: -40 to -7 dBm Measurement Accuracy: \pm 1 dB (-30 to -10 dBm), \pm 2 dB (-9.9 to -7 dBm, -40 to -30.1 dBm)	
	9953.28 Mbit/s to 11095.727 Mbit/s Wavelength: 1310 nm/1550 nm Measurement Range: -20 to +3 dBm Measurement Accuracy: \pm 2 dB	
Frequency Counter	Measurement Frequency (f0): 1.544, 2.048, 8.448, 34.368, 44.736, 51.84, 139.264, 155.52, 622.08, 2488.320, 2666.057 (Option-05/005 installed), 9953.28*2, 10312.5 (Option-008 installed)*2, 10709.225 (Option-005 installed)*2, 11049.107 (Option-006 installed)*2, 11095.727 (Option-006 installed)*2 MHz Measurement Range: f0 \pm 100 ppm Accuracy: \pm 0.2 ppm	
Auxiliary Interface	External Clock Input, Receive Clock Output, Clock/Frame Sync. Output	

Model	MU150110A	MU150101A*1																																																												
Optical Output Power Adjustable (Option-04/004)	Bit Rate: 51.84 Mbit/s to 2666.057 Mbit/s Variable Range: 0 to 30 dB Accuracy: ± 0.5 dB (0 to 10 dB), ± 1.0 dB (10.1 to 30 dB) Setting Resolution: 0.1 dB																																																													
Jitter Tolerance (52M to 2.5G/2.6G)	<table border="1"> <thead> <tr> <th>Bit Rate (Mbit/s)</th> <th>A1 (UIp-p)</th> <th>A2 (UIp-p)</th> <th>A3 (UIp-p)</th> <th>f6 (Hz)</th> <th>f7 (Hz)</th> <th>f1 (Hz)</th> <th>f2 (Hz)</th> <th>f3 (Hz)</th> <th>f4 (Hz)</th> </tr> </thead> <tbody> <tr> <td>51.84</td> <td>0.2</td> <td>2</td> <td>20</td> <td>10</td> <td>30</td> <td>300</td> <td>2k</td> <td>20k</td> <td>400k</td> </tr> <tr> <td>155.52</td> <td>0.2</td> <td>2</td> <td>50</td> <td>10</td> <td>19.3</td> <td>500</td> <td>6.5k</td> <td>65k</td> <td>1.3M</td> </tr> <tr> <td>622.08</td> <td>0.2</td> <td>2</td> <td>200</td> <td>10</td> <td>10</td> <td>1k</td> <td>25k</td> <td>250k</td> <td>5M</td> </tr> <tr> <td>2488.32</td> <td>0.2</td> <td>2</td> <td>800</td> <td>10</td> <td>12.1</td> <td>5k</td> <td>100k</td> <td>1M</td> <td>20M</td> </tr> <tr> <td>2666.05*</td> <td>0.2</td> <td>2</td> <td>800</td> <td>10</td> <td>12.1</td> <td>5k</td> <td>100k</td> <td>1M</td> <td>20M</td> </tr> </tbody> </table> <p style="text-align: right;">*: When MU150125A-05 installed.</p> <p>Measurement Condition: MU150110A/MU150101A Loop-back Measurement Temperature Condition: 10° to 40°C Optical Input Level: -12 to -10 dBm (2488 M, 2666 M), -20 to -10 dBm (52 M, 156 M, 622 M) Error Threshold: 10⁻⁸ (52 M), 10⁻⁹ (156 M, 622 M), 10⁻¹⁰ (2488 M, 2666 M) Optical Input Wavelength: 1310 nm/1550 nm Mapping SDH: VC3-Bulk (52 M), VC4-nc (n = 1, 4, 16) (156 M/622 M/2488 M) SONET: STSnc (n = 1, 3, 12, 48) OTU1: ODU1-OPU1-PRBS Test Pattern: PRBS 2²³ - 1 (Inv.) (SDH/SONET), PRBS 2²³ - 1 (OTU1), Mark Ratio 1/2, Scramble On Clock: Internal</p>	Bit Rate (Mbit/s)	A1 (UIp-p)	A2 (UIp-p)	A3 (UIp-p)	f6 (Hz)	f7 (Hz)	f1 (Hz)	f2 (Hz)	f3 (Hz)	f4 (Hz)	51.84	0.2	2	20	10	30	300	2k	20k	400k	155.52	0.2	2	50	10	19.3	500	6.5k	65k	1.3M	622.08	0.2	2	200	10	10	1k	25k	250k	5M	2488.32	0.2	2	800	10	12.1	5k	100k	1M	20M	2666.05*	0.2	2	800	10	12.1	5k	100k	1M	20M	
Bit Rate (Mbit/s)	A1 (UIp-p)	A2 (UIp-p)	A3 (UIp-p)	f6 (Hz)	f7 (Hz)	f1 (Hz)	f2 (Hz)	f3 (Hz)	f4 (Hz)																																																					
51.84	0.2	2	20	10	30	300	2k	20k	400k																																																					
155.52	0.2	2	50	10	19.3	500	6.5k	65k	1.3M																																																					
622.08	0.2	2	200	10	10	1k	25k	250k	5M																																																					
2488.32	0.2	2	800	10	12.1	5k	100k	1M	20M																																																					
2666.05*	0.2	2	800	10	12.1	5k	100k	1M	20M																																																					
Jitter Tolerance*2 (9.9G/10.7G)	<table border="1"> <thead> <tr> <th>Bit Rate (Mbit/s)</th> <th>A1 (UIp-p)</th> <th>A2 (UIp-p)</th> <th>A3 (UIp-p)</th> </tr> </thead> <tbody> <tr> <td>9953</td> <td>0.2</td> <td>2</td> <td>3200</td> </tr> <tr> <td>10709*</td> <td>0.2</td> <td>2</td> <td>3200</td> </tr> </tbody> </table> <table border="1"> <thead> <tr> <th>Bit Rate (Mbit/s)</th> <th>f6 (Hz)</th> <th>f7 (Hz)</th> <th>f1 (Hz)</th> <th>f2 (Hz)</th> <th>f3 (Hz)</th> <th>f4 (Hz)</th> </tr> </thead> <tbody> <tr> <td>9953</td> <td>10</td> <td>12.1</td> <td>20k</td> <td>400k</td> <td>4M</td> <td>80M</td> </tr> <tr> <td>10709*</td> <td>10</td> <td>12.1</td> <td>20k</td> <td>400k</td> <td>4M</td> <td>80M</td> </tr> </tbody> </table> <p style="text-align: right;">*: When MU150125A-05 installed.</p> <p>Measurement Condition: MU150110A, MU150121A/B, MU150123A/B Loop-back Measurement Temperature Condition: 10° to 40°C Optical Input Level: -12 to -10 dBm Optical Input Wavelength: 1310 nm/1550 nm Mapping SDH: VC4-64c (9953 M) SONET: STS192c (9953 M) OTU2: ODU2-OPU2-PRBS Test Pattern: PRBS 2²³ - 1 (Inv.) (SDH/SONET), PRBS 2³¹ - 1 (OTU2), Mark Ratio 1/2, Scramble On Clock: Internal</p>	Bit Rate (Mbit/s)	A1 (UIp-p)	A2 (UIp-p)	A3 (UIp-p)	9953	0.2	2	3200	10709*	0.2	2	3200	Bit Rate (Mbit/s)	f6 (Hz)	f7 (Hz)	f1 (Hz)	f2 (Hz)	f3 (Hz)	f4 (Hz)	9953	10	12.1	20k	400k	4M	80M	10709*	10	12.1	20k	400k	4M	80M																												
Bit Rate (Mbit/s)	A1 (UIp-p)	A2 (UIp-p)	A3 (UIp-p)																																																											
9953	0.2	2	3200																																																											
10709*	0.2	2	3200																																																											
Bit Rate (Mbit/s)	f6 (Hz)	f7 (Hz)	f1 (Hz)	f2 (Hz)	f3 (Hz)	f4 (Hz)																																																								
9953	10	12.1	20k	400k	4M	80M																																																								
10709*	10	12.1	20k	400k	4M	80M																																																								
Laser Safety	IEC 60825-1: 2007: CLASS 1 21CFR1040.10*3																																																													

*1: For the specifications when using the EoS mode with the MU150101A, see the items for MU150101A-06, and MU150101A-07 options.

*2: Not supported with MU150101A.

*3: Excludes deviations caused by conformance to Laser Notice No. 50 dated June 24, 2007

*4: To use the optical output (51.84 Mbit/s to 2666.057 Mbit/s) attach a 50-Ω terminator (J0994) to the SMA connector used for the data output of the electrical interface (9953.28M, 10312.5M, 10709.225 Mbit/s).

Safety measures for laser products

This product complies with optical safety standards in 21CFR1040.10 and IEC 60825-1; the following descriptive labels are affixed to the product.



- MU150110A-005 OTU1/OTU2
- MU150110A-006 11.1G (OTN specification only)
- MU150101A-05 OTU1

Option	MU150110A-005	MU150110A-006	MU150101A-05*1
Bite Rate	10709.225 Mbit/s, 2666.057 Mbit/s	11049.107 Mbit/s, 11095.727 Mbit/s	2666.057 Mbit/s
Frame	10709.225 Mbit/s: OTU2 2666.057 Mbit/s: OTU1	11049.107 Mbit/s: OTU1e 11095.727 Mbit/s: OTU2e	2666.057 Mbit/s: OTU1
No Frame	10709.225 Mbit/s, 2666.057 Mbit/s	11049.107 Mbit/s, 11095.727 Mbit/s	2666.057 Mbit/s
Test Pattern	PRBS, Word, All 0, All 1 PRBS No Frame: $2^{15} - 1$, $2^{23} - 1$, $2^{31} - 1$ PRBS Mapping: $2^{15} - 1$, $2^{23} - 1$, $2^{31} - 1$ SDH/SONET Mapping: According to SDH/SONET Mapping Invert On/Off Word: 16-bit Programmable (Mark Ratio 1/2 at No Frame) Transmit/Receive: An independent setup is possible		
Overhead Preset	OTU, ODU, OPU, FAS (except Parity Byte, MFAS and JC Byte) TTI (SPAI [1] - [15], DAPI [1] - [15]) can be set character. PT is set automatically according to mapping (can be edit).		
FEC	G.709, RS (255, 239) On/Off		
Justification	Generation Action: \pm Justification Timing: Single, Burst (2 to 64)	Measurement Item: + JC, -JC	
Payload Offset	Offset Range: ± 65.9 ppm/0.1 ppm step set at Async. Mapping.		
Error Addition/Measurement	FAS, BIP-8 (SM, PM, TCM1-6), BEI (SM, PM, TCM1-6), Bit All (Addition for OTN Frame only), Bit, Corrected Error Bit (Measurement only), Uncorrectable FEC Block (Measurement only)		
Error Addition Timing	Single, Rate, All, Alternate, Random (Only Bit All) Rate Fix Rate: 1×10^{-n} (n: 3 to 9), User Program: $A \times 10^{-B}$ (A: 1.0 to 9.9, B: 2 to 10) Alternative Error Frame: 0 to 64000, Normal Frame: 1 to 64000 Random: Poisson distributed error insertion (only at Bit all) Specify insertion bit position at parity error insertion		
Alarm Addition/Measurement	LOF, OOF (Measurement only), LOM, OOM (Measurement only), BDI (SM, PM, TCM1-6), AIS (OTU, ODU, Client*2), ODU-OCI, ODU-LCK, ODU-PLM (Measurement only), IAE (SM, TCM1-6), TIM (SM, PM, TCM1-6), LTC (TCM1-6), BIAE (SM, TCM1-6)		
Alarm Addition Timing	Alternative, All, Burst, Single Alternative Error Frame: 0 to 64000, Normal Frame: 1 to 64000		
Monitor	All OH (OTU, ODU, OPU), TTI, FTFL, Payload Multi-frame supported of TTI and FTFL.		
Overhead Sequence Capture	Capture Byte: APS/PCC Size: 64 Sequence Repeat: Max. 8000 Frames/Sequence		
Overhead Test	OTU/ODU/OPU 1 Byte, FAS, APS/PCC, TCM1-6, SM, PM, GCC0-2, EXP (except Parity Byte, MFAS and JC Byte) Timing: Alternative (A: 1 to 8000 times, B: 1 to 8000 times), A and B set up to 256 frames		
Overhead BERT Test	GCC0-2, OH 1 Byte (except Parity Byte) Pattern: PRBS $2^{11} - 1$, PRBS $2^{15} - 1$ (Invert)	Error Addition: Bit (Only Single) Measurement: Bit Error, Sync Loss	
Overhead Add/Drop	Test Byte: GCC0-2		

*1: MU150101A does not support OTN measurement in EoS mode.

*2: Not supported with MU150101A-05.

- MU150110A-006 11.1G (10G Ethernet specification only)
- MU150110A-008 10.3G

Option	MU150110A-006	MU150110A-008
Bit Rate	11049.107 Mbit/s, 11095.727 Mbit/s	10312.5 Mbit/s
Frame	11049.107 Mbit/s: OTU1e 11095.727 Mbit/s: OTU2e	10312.5 Mbit/s: 10G Ethernet
No Frame	11049.107 Mbit/s, 11095.727 Mbit/s	10312.5 Mbit/s
Ethernet Settings (General)	Maximum Frame Size: 64 bytes to 16,384 bytes IPG Violation Threshold: 5 to 12 bytes Link Fault Signaling Reply: On/Off Flow Control Receive: On/Off	
Ethernet Settings (Frame)	Frame Length: 48 bytes to 16,384 bytes Auto, Fixed, Increment, Random selectable *Only Auto or Fixed when test frame selected in data field VLAN: On/Off TPID, User Priority, CFI editable VLAN ID settable (Fixed, Increment, Decrement, Random) Background Data: All 0, All 1 Preamble Size: 4 bytes to 255 bytes (can edit all bytes except 1-byte header) MAC Address: Separate source and destination address settings Type: Fixed, Increment, Decrement, Random Mask: Set in 4-bit units (when Increment, Decrement, Random selected) Ethernet Type: Editable Data Field: All 0, All 1, Word 16, Increment, Decrement, Programmable, Test Frame Offset: 0 to 16,365 bytes Error Insertion: FCS Error, Fragments, Undersize, Oversize, Oversize & FCS Error	
User Defined Counter Settings	Separate User Defined Counter 1, 2 settings Pattern 1: Don't care, Match, Mismatch Pattern 2: Don't care, Match, Mismatch Error: Don't care, Match, Mismatch User Defined Counter 1, 2 common setting Pattern 1, 2: Pattern: 128 bits Mask: Byte units Base Position: Top of Frame Offset: 0 to 16,368 bytes Preset Pattern: MAC DA, MAC SA, Ethernet Type Error Type: Good frame, FCS error, Undersize, Fragments, Oversize, Oversize & FCS error, Sequence error	
Stream Control	Tx Mode: Repeat, Burst (Repeat only at Latency and BER measurements) Burst Length: 1 to 65,536 frames Gap Insertion Type: Fixed, Random Value: 7.2 ns to 120 s (0.8 ns resolution)	
Error Insertion (PCS)	Type: Sync header, Block type Timing: Single, Burst, Rate, Alternate, All Burst: 1 to 64,000 Rate: 1.0E-3 to 0.1E-11 Alternate: Error: 1 to 64,000, Normal: 0 to 64,000	
BER Test	Type: Framed, No frame Test Pattern: All 0, All 1, Word 16, PRBS23 (Invert On/Off), PRBS31 (Invert On/Off), CJPAT (fixed gap and frame length), CRPAT (fixed gap and frame length) Error Insertion Type: Bit Timing: Single, Rate Rate: 1.0E-4 to 1.0E-9 MAC Address (only Framed mode) Separate source and destination address settings Type: Fixed, Increment, Decrement, Random Mask: Set in 4-bit units (when Increment, Decrement, Random selected) Gap Insertion Type: Fixed, Random Value: 7.2 ns to 120 s (0.8 ns resolution) Frame Length: 48 bytes to 16,384 bytes Fixed, Increment, Random selectable	

Option	MU150110A-006	MU150110A-008
PCS Test	<p>Test Mode: Pattern, 66B programmable data</p> <p>Pattern Pattern: Pseudo-random, Square wave, PRBS31 Seed: Seed A, Seed B (editable) Data: LF, All 0</p> <p>66B Programmable Data Size: 1 to 256 Block</p> <p>Error Insertion (only Pattern mode) Type: Bit Timing: Single, Rate Rate: 1.0E-3 to 1.0E-11</p> <p>PCS Capture Block No.: 4,096 max. (decode)</p> <p>Filter/Trigger Settings On/Off Sync header: Don't care, Match, Mismatch Block type: Don't care, Match, Mismatch Error: Don't care, Match, Mismatch Alarm: Don't care, Match, Mismatch (trigger only) External: Don't care, Match, Mismatch (trigger only)</p> <p>Filter/Trigger Condition Sync header: Data (01), Control (10) Block type: IEEE802.3, Start, Terminate, Ordered_set, Programmable Error: No error, Sync header, Errored block, Block type, IPG violation Alarm: No alarm, Unlock Combination: And Trigger Position: Top, Middle, Bottom</p>	
Latency	<p>MAC Address Separate source and destination address settings Type: Fixed, Increment, Decrement, Random Mask: Set in 4-bit units (when Increment, Decrement, Random selected)</p> <p>Gap Insertion Type: Fixed, Random Value: 7.2 ns to 120 s (0.8 ns resolution)</p> <p>Frame Length: 48 bytes to 16,384 bytes Selectable at Fixed</p> <p>Measurement Result Display: Current, Maximum, Minimum, Average, Frame Count Current, Average, Frame Count: Test frame at 1 sec sampling Maximum, Minimum: All received test frames</p>	
Link Fault Signaling	<p>Send Data Signal Pattern: Remote fault signal, Local fault signal, Edit signal (only Lane 1, 2, 3 editable)</p> <p>LFS Capture Column No.: 512 max. (decode) Trigger Setting: On/Off (settable pattern) Display Filter: All, Sequence only</p>	
Counters	<p>Error/Alarm PCS: Link down, Unlock, Hi-BER, Pattern sync, Sync header, Errored block, Code, Block type, IPG violation, Pattern block, Pattern bit Ethernet: Oversize, Oversize & FCS error, Undersize, Fragments, FCS error, Sequence error BER: Sync., Bit</p> <p>Count: Transmitted/Received Frame, Transmitted/Received Byte, Transmitted/Received Test Frame, Transmitted/Received RF Signal, Transmitted/Received LF Signal, Received User Defined 1, Received User Defined 2, Received Pause, Received Capture Filter, Received Capture Trigger</p> <p>Rate: Transmitted/Received Frame (fps), Transmitted/Received Bit (%), Transmitted/Received Bit (bit/s), Transmitted/Received Rate (%), Received User Defined 1 (fps), Received User Defined 2 (fps)</p>	

• MU150110A-010 Multichannel Measurement*1

Bit Rate	51.84 Mbit/s, 155.52 Mbit/s, 622.08 Mbit/s, 2488.32 Mbit/s, 9953.28 Mbit/s
Frame	51.84 Mbit/s: SDH/SONET 155.52 Mbit/s: SDH/SONET 622.08 Mbit/s: SDH/SONET 2488.32 Mbit/s: SDH/SONET 9953.28 Mbit/s: SDH/SONET
Mapping	Auto-search: Auto-detect Rx mapping Unequipped: Selectable for each channel (On/Off) Measurement: Selectable for each channel (On/Off)
Test Pattern	PRBS, Word 16, All 0, All 1 PRBS: 2 ¹⁵ - 1, 2 ²³ - 1, 2 ³¹ - 1, Invert On/Off Independent setting for each channel but Word 16 pattern shared by all channels
Overhead Preset	SOH/TOH/POH: All bytes (except Parity, K1/K2, and H1/H2/H3) Independent setting for all channels
Error Addition	Simultaneous insertion into multichannels Selectable On/Off addition to each channel Shared Type and Timing for all channels PDH/DSn: Bit info SDH: FAS, B1, B2, HP-B3, LP-B3, BIP-2, MS-REI (M0/M1), HP-REI, LP-REI, Bit all, Bit info SONET: FAS, B1, B2, HP-B3, LP-B3, BIP-2, REI-L (M0/M1), REI-P, REI-V, Bit all, Bit info Timing: Rate, Alternative, Single, Burst Rate: Fix Rate: 1 × 10 ⁻ⁿ (n: 3 to 9), User Program: A × 10 ^{-B} (A: 1.0 to 9.9, step 0.1, B: 2 to 10) Alternative: Error Frame: 0 to 64,000, Normal Frame: 1 to 64,000 Specify insertion bit position at B1, B2, B3, BIP-2 error insertionple
Error Measurement	Simultaneous measurement of multiple channels PDH/DSn: Bit SDH: Frame, B1, B2, HP-B3, LP-B3, BIP-2, MS-REI (M0/M1), HP-REI, LP-REI, Bit SONET: Frame, B1, B2, HP-B3, LP-B3, BIP-2, REI-L (M0/M1), REI-P, REI-V, Bit
Alarm Addition	Simultaneous insertion into multiple channels Selectable On/Off addition to each channel Shared Type and Timing for all channels PDH/DSn: LOF, AIS SDH: LOS, LOF, RS-TIM, MS-AIS, MS-RDI, AU-AIS, AU-LOP, HP-RDI, HP-ERDIP, HP-ERDIS, HP-ERDIC, HP-TIM, HP-UNEQ, HP-SLM, TU-AIS, TU-LOP, TU-LOM, LP-RDI, LP-ERDIP, LP-ERDIC, LP-ERDIC, LP-RFI, LP-TIM, LP-UNEQ, LP-SLM SONET: LOS, LOF, RS-TIM, AIS-L, RDI-L, AIS-P, LOP-P, RDI-P, ERDIP-P, ERDIS-P, ERDIC-P, TIM-P, UNEQ-P, PLM-P, AIS-V, LOP-V, LOM-V, RDI-V, ERDIP-V, ERDIC-V, ERDIC-V, RFI-V, TIM-V, UNEQ-V, PLM-V Timing: Single, Burst, Alternative, All (only All for PDH) Alternative: Error Frame: 0 to 64,000, Normal Frame: 1 to 64,000
Alarm Measurement	Simultaneous measurement of multiple channels PDH/DSn: LOF, AIS (only status display) Sync. SDH: LOS, Generic-AIS, LOF, OOF, RS-TIM, MS-AIS, MS-RDI, AU-AIS, AU-LOP, HP-RDI, HP-ERDIP, HP-ERDIS, HP-ERDIC, HP-TIM, HP-UNEQ, HP-SLM, TU-AIS, TU-LOP, TU-LOM, LP-RDI, LP-ERDIP, LP-ERDIC, LP-ERDIC, LP-RFI, LP-TIM, LP-UNEQ, LP-SLM, Sync. loss SONET: LOS, Generic-AIS, LOF, OOF, RS-TIM, AIS-L, RDI-L, AIS-P, LOP-P, RDI-P, ERDIP-P, ERDIS-P, ERDIC-P, TIM-P, UNEQ-P, PLM-P, AIS-V, LOP-V, LOM-V, RDI-V, ERDIP-V, ERDIC-V, ERDIC-V, RFI-V, TIM-V, UNEQ-V, PLM-V, Sync. loss
Monitor	SOH/TOH/POH, Path Trace, K1/K2 Byte, AU/STS, TU/VT Pointer, Payload
Path Monitor	Displays errors and alarms at each channel
Through	Transparent, OH Overwrite
Delay Measurement	Simultaneous measurement of multiple channels Measurement Period: 0.5, 1, 2, 5, 10 s Measurement Range: 0 to 10,000,000.0 μs (0.1 μs step), >Timeout
Path Trace	Independent setting for all channels but CRC On/Off shared by all channels J0, J1, J2 byte set arbitrarily 16 bytes (CRC On), 64 bytes (CRC Off, J1 only) Auto-detection of path trace pattern
Pointer Generation	Independent setting for all channels AU/STS, TU/VT Pointer Action: NDF, ±PJ (Pointer Justification) PJC Timing: Manual, Burst (2 to 64)
Pointer Measurement	Independent setting for all channels AU/STS, TU/VT Pointer, C Bit Measurement Item: NDF, +PJC, -PJC, Cons, C, C1/C2
APS Test	Switching Time Measurement Simultaneous measurement of multiple channels Measurement Time: 0.1 ms to 2000.0 ms, Timeout (exclude Time for Frame/Pointer Synchronization) Threshold: 1 ms to 100 ms (1-ms steps) Measurement Result: Current, Maximum, Minimum, Average (ms) OK (Pass), NG (Fail) (Count)
Log Function	Log Period: 1 s Target: Events (selectable items), APS Test

*1: This option and the Ethernet unit (MU120XXXX) cannot be used simultaneously.

Set the Multichannel Option setting of the Setup Utility to On when using this option with the MU150110A and Ethernet unit installed in the MP1590B.

- MU150101A-06 GFP-F/LEX/LAPS
- MU150101A-07 POS

Option	MU150101A-06	MU150101A-07
Optical Interface	Bit Rate: 155.52 Mbit/s, 622.08 Mbit/s, 2488.32 Mbit/s	
Encapsulation	GFP-F, LEX, LAPS (X.86)	PPP, CiscoHDLC, MAPOS version1, MAPOS 16
Encapsulation Setting	<p>GFP</p> <p>Scramble: On/Off (supports independent Core Header and Payload Area setup)</p> <p>Descramble: On/Off (supports independent Core Header and Payload Area setup)</p> <p>FCS: 32 Bit</p> <p>Receive Conditions</p> <p>Extension Header Size</p> <p>Extension Header Size other than NULL or Linear 2 Byte to 58 Byte (except eHEC)</p> <p>cHEC Presync Times: 1 to 16</p> <p>CSF Recovery: 1 to 16 Payload Header Checking: On/Off</p> <p>Ethernet MAC Address</p> <p>Ethernet Maximum Frame Size (64 Byte to 65535 Byte)</p> <p>LAPS</p> <p>Scramble/Descramble: On Only</p> <p>Minimum Flag Length: 1 Byte/2 Byte</p> <p>FCS: 32 Bit</p> <p>Rate Adaptation X/Y (Add X Byte Every Y Frame Byte)</p> <p>X: 0 to 1024 Byte/16 Byte</p> <p>Y: 4096/8192/16384/32768/65536</p> <p>Ethernet MAC Address</p> <p>Ethernet Maximum Frame Size (64 Byte to 65535 Byte)</p> <p>LEX</p> <p>Scramble/Descramble: On/Off</p> <p>Minimum Flag Length: 1 Byte/2 Byte</p> <p>FCS: 16 Bit</p> <p>Negotiation</p> <p>On/Off, Restart, Retry, Abort, Max-Receive-Unit (MRU: Default 1500), Magic-Number (Random), IPCP (Send this port IP Address) Retry (1 to 10), Time Out (1 to 180)</p> <p>PPP-LEX: Send Startup Command Opt On/Off, MAC Address</p>	<p>PPP/CiscoHDLC/MAPOS version1/MAPOS 16:</p> <p>Scramble: On/Off</p> <p>Descramble: On/Off</p> <p>Minimum Flag Length: 1 Byte/2 Byte</p> <p>FCS: 16 Bit/32 Bit</p> <p>Negotiation: (PPP only; MRU enabled for all) On/Off, Restart, Retry, Abort, Max-Receive-Unit (MRU: default1500), Magic-number (random), IPCP (Send this port IP address) Retry (1 to 10), Time Out (1 to 180)</p>
Frame Setting	<p>FCS (LEX): 16 Bit</p> <p>MAC Address: Fixed, Increment, Decrement, Random (Changeable parts specified in 4 Bit units)</p> <p>IP Address: Fixed, Increment, Decrement, Random</p> <p>VLAN Tag*1: Fixed, Increment, Decrement, Random</p> <p>Protocol Editing:</p> <p>GFP, LEX, LAPS, Ethernet, ARP, IPv4, IGMP/IPv4, ICMP/IPv4, TCP/IPv4, UDP/IPv4, RIP/UDP/IPv4, DHCP/UDP/IPv4, IPv6, IPX, IS-IS, MAC Control Frame, LEX Control Packet</p>	<p>FCS: CRC32, CRC16</p> <p>IP Address: Fixed, Increment, Decrement, Random</p> <p>Protocol Editing:</p> <p>PPP, CiscoHDLC, MAPOS v1, MAPOS 16, ARP, IPv4, IGMP/IPv4, ICMP/IPv4, TCP/IPv4, UDP/IPv4, RIP/UDP/IPv4, DHCP/UDP/IPv4, IPv6, IS-IS</p>
Frame Length	<p>MPLS Label*1: Up to 10 MPLS labels appended.</p> <p>Data Field: All1, All0, Alternate1/0 (by bit, 2 bit, nibble, byte, 2 byte) Increment by byte*2, Decrement by byte*2, Random by bytes*2, PRBS9*2, [Only Data field 1] Time Stamp*2, Sequence Number*2, Programmable, Test frame, Test Frame for MU120101A</p> <p>Fixed: GFP 8,12,16 Byte to 65535 Byte PPP/LEX/LAPS 8 Byte to 65535 Byte (Packet Length + IFG ≥16 Byte)</p> <p>Random: 64 Byte to 65535 Byte (IFG ≥16 Byte)*3</p> <p>Increment: 64 Byte to 65535 Byte (IFG ≥16 Byte)*3</p> <p>Auto: Sets frame size to minimum required for selected protocols.</p>	
Stream Setting	<p>Distribution Patterns: Continuous, Continuous Burst, Stop after this Stream, Next Stream, Jump to Stream, Jump to Stream for count (Jump to stream No.1 to 256, Loop count: 1 to 16000000, Frames per burst: 1 to 16000000)</p> <p>Bursts per stream: 1 to 16000000)</p> <p>Inter Frame Gap: GFP 0 ns to 2 minutes (13.4 ns step), PPP/LEX/LAPS 3.3 ns to 2 minutes (3.3 ns step)</p> <p>Random*4: 53.5 ns to 2 minutes (Frame Length ≥64 Byte)</p> <p>Inter Burst Gap: GFP 53.5 ns to 2 minutes (13.4 ns step), PPP/LEX/LAPS 3.3 ns to 2 minutes (3.3 ns step)</p> <p>Inter Stream Gap: GFP 53.5 ns to 2 minutes (13.4 ns step), PPP/LEX/LAPS 3.3 ns to 2 minutes (3.3 ns step)</p>	
Error Addition	<p>GFP: cHEC error, correctable cHEC error, tHEC error, correctable tHEC error, eHEC error, correctable eHEC error, FCS error</p> <p>LAPS (X.86): FCS error, Aborted Sequence</p> <p>LEX: FCS error, Fragments error, Undersize error, Oversize error, Oversize & FCS error, Aborted Sequence</p> <p>Ethernet: FCS error, Fragments error, Undersize error, Oversize error, Oversize & FCS error</p>	<p>PPP: FCS Error, Undersize, Oversize, Fragments Error, Oversize & FCS Error, Aborted Frame</p>
	Network layer: IP header checksum Error, TCP/UDP checksum error, PRBS9 Error (option-11)	

Option	MU150101A-06	MU150101A-07
Counter	GFP: Transmitted Frame (frames and fps), Transmitted Byte, Transmitted Bit Rate (% and bit/s), Received Frame (frames and fps), Received Byte, Received Bit Rate (% and bit/s), Transmitted Rate (%) Received Rate (%), cHEC Error, correctable cHEC Error, tHEC Error, correctable tHEC Error, eHEC Error, FCS Error, Server Signal Fail Interval, Client Loss of Sync Frame, Client Loss of Sync Interval, Client Loss of Signal Frame, Client Loss of Signal Interval	PPP: Transmitted Bit Rate (bit/s and %), Transmitted Rate (%), Transmitted Bytes After Stuffing, Transmitted Byte, Transmitted Frame(frames and fps), Received Bit Rate (bit/s and %), Received Rate (%), Received Bytes Before Destuffing, Received Byte, Received Frame (frames and fps), Oversize, Oversize & FCS Error, Undersize, Fragments, FCS Error, Aborted Frame
	LAPS (X.86): Transmitted Frame (frames and fps), Received Frame (frames and fps), Transmitted Byte, Transmitted Bytes After Stuffing, Transmitted Bit Rate (% and bit/s), Received Byte, Received Bytes Before Destuffing, Received Bit Rate (% and bit/s), Transmitted Rate (%), Received Rate (%), FCS error, Fragments, Undersize, Oversize, Oversize & FCS Error, Aborted frame	—
	LEX : Transmitted Frame (frames and fps), Transmitted Byte, Transmitted Byte After Adaptation, Transmitted Bytes After Stuffing, Transmitted Bit Rate (% and bit/s), Received Frame (frames and fps), Received Byte, Received Byte Before Adaptation, Received Bytes Before Destuffing, Received Bit Rate (% and bit/s), Transmitted Rate (%), Received Rate (%), FCS error, Aborted frame	—
	SDH/SONET: B1, B2, MS-REI, Bit Info [Count/Rate] LOS, LOF, OOF, MS-AIS, MS-RDI [Count/Second] B3, BIP2, HP-REI, LP-REI, SQM [Count/Rate]: (with HO/LO VCAT Option) AU-AIS, AU-LOP, HP-SLM, HP-RDI, HP-UNEQ, VCAT-LOM, OOM1 (HO), OOM2 (HO) [Count/Second]: (with HO VCAT Option) TU-AIS, TU-LOP, TU-LOM, LP-RDI, LP-SLM, LP-UNEQ, Pattern Sync. Loss, VCAT-LOM, OOM (LO) [Count/Second]: (with LOVCAT Option) GID, CRC8 (HO), CRC3 (LO) [Count/Rate] LOA [Count/Second]: (with LCAS Option) Justification: NDF, +PJC, - PJC, Consecutive [Count/Rate], PPM Bulk: Bit Info [Count/Rate], Pattern Sync. Loss [Second]	—
	Ethernet: Transmitted Ethernet Frame (packets and fps), Transmitted Ethernet Byte, Received Ethernet Frame (packets and fps), Received Ethernet Byte, Transmitted Ethernet Bit Rate (%), Received Ethernet Bit Rate (%), Ethernet FCS error, Ethernet Fragments error, Ethernet Undersize error, Ethernet Oversize error, Ethernet Oversize & FCS error, Transmitted ARP Reply, Transmitted ARP Request, Received ARP Reply, Received ARP Request	—
Other: Transmitted IPv4 Packet (packets and pps), Received IPv4 Packet (packets and pps), IPv4 Header Checksum Error, Received UDP Packet (packets and pps), Received TCP Packet (packets and pps), TCP Checksum Error, UDP Checksum Error Capture Trigger, Capture Filter, Transmitted Ping Reply, Transmitted Ping Request, Received Ping Reply, Received Ping Request, QoS 0 to 7 (packets and fps), User defined × 2 (packets and fps), Transmitted Test Pattern, Received Test Pattern Packet Error: Sequence Error, PRBS Frame Error [Count/Rate], PRBS Bit Error (with MP1590B-11)	—	
Frame Arrival Time	Time Resolution: 1 μs, 10 μs, 100 μs, 1 ms, 10 ms, 100 ms, 1 s	
QoS Counter	Using QoS described below, 8-level Priority Frame Count: IEEE802.1D VLAN Tag User Priority Field or IPv4 ToS Field	
Unframed BER Test	Test Pattern: PRBS (2 ²³ - 1, 2 ³¹ - 1) Error Insertion: Bit Unit Error Insertion Timing: Single Error, Fix Rate, User Program Fix Rate: 1 × 10 ⁻ⁿ (n: 3 to 9), User Program: A × 10 ^{-B} (A: 1.0 to 9.9, B: 2 to 10)	
Capture Buffer	256 Mbyte	
Capture Filter	At following conditions, Capture Filter Condition Settings: Destination MAC Address*5, Source MAC Address*5, Destination IP Address, Source IP Address, 32-bit Pattern (settable Bit Length and Offset) × 2, Error Conditions	
Capture Trigger	At following conditions, Capture Trigger Condition Settings: Destination MAC Address*5, Source MAC Address*5, Destination IP Address, Source IP Address, 32-bit Pattern (settable Bit Length and Offset) × 2, Error Conditions, Traffic Over, Latency Over, External Trigger Input	
Protocol Decode	ARP, CiscoHDLC, DHCP, DVMRP, Ethernet, GFP, ICMP, ICMPv6, IGAP, IGMP, IPCP, IPv4, IPv6, IPv6CP, IPX, IS-IS, LAPS (X.86), LCP, LDP, LEX, LLC, MAC Control Frame, MAPOS, MPLS, MPLSCP, OSPFv2, PPP, PPP-LEX, RIP, RSVP, SNAP, TCP, UDP, VLAN, Test Frame	
Protocol Emulation	ARP, PPP, ICMPv4 (PING), IGMP	
Traffic Monitor	Switch IP packet count for 64 streams max. and 64 protocols max.	
Traffic Map	Switch IP flow for 256 streams max.	
Service Disruption Time	Measure time when frames not received; resolution depends on Tx signal frame length and IFG	

- *1: VLAN tag and MPLS labels cannot be used simultaneously.
- *2: This function causes a TCP/UDP checksum error when using TCP/ UDP frames.
- *3: Increment and random frame length can be used only when none chosen as protocol.
- *4: Random setting is enabled only when frame length is more than 64 bytes.
- *5: Supported only at GFP/LAPS/LEX mapping

- MU150101A-11 HO Virtual Concatenation
- MU150101A-12 LO Virtual Concatenation

Option	MU150101A-11	MU150101A-12
Contiguous Concatenation Mapping	VC4 - Nc (N = 16, 8, 4, 3, 2), VC4, VC3, VC4-Xc (X = 1 to 16) Size: VC4-Xc: 1 to 16 (2488.320 Mbit/s), VC4-Xc: 1 to 4 (622.080 Mbit/s)	
Virtual Concatenation Mapping	AU4-VC4-Xv (STS3c-Xv) AU3-VC3-Xv (STS1-Xv)	AU4-TUG3-VC3-Xv AU4-TUG3-TUG2-VC12-Xv AU3-TUG2-VC12-Xv AU4-TUG3-TUG2-TU11-VC11-Xv AU3-TUG2-TU11-VC11-Xv
Virtual Concatenation Group	2488.320 Mbit/s AU4-VC4-Xv: 1 to 16, AU4/3-VC3-Xv: 1 to 48 622.080 Mbit/s AU4-VC4-Xv: 1 to 4, AU4/3-VC3-Xv: 1 to 12 155.520 Mbit/s AU4/3-VC3-Xv: 1 to 3	2488.320 Mbit/s TU12-VC12-Xv: 1 to 63, TU11-VC11-Xv: 1 to 64* 622.080 Mbit/s TU12-VC12-Xv: 1 to 63, TU11-VC11-Xv: 1 to 64* 155.520 Mbit/s TU12-VC12-Xv: 1 to 63, TU11-VC11-Xv: 1 to 64* (*: VCG Size is 1 to 84, Provisioned Size is 1 to 64 at LCAS On)
	Ch: Set Ch position as VCG member; set any Ch sequence. For AU4-VC3-Xv, VC12-Xv, VC11-Xv, set all AUch as range and Ch position and Ch sequence across AU-Ch	
Detect VCG (Require MU150101A-13)	Rx signal analysis and VCG group detection IDLE evaluated based on Ctrl value. For AU4-VC3-Xv, VC11-Xv, VC12-Xv, detect VCG across AU-Ch Function supported for LCAS connection	
Error Addition	Contiguous Concatenation: FAS, Bit all, B1, B2, MS-REI, Bit info. Error, HP-B3, HP-REI Virtual Concatenation: FAS, Bit all, B1, B2, MS-REI, Bit info. Error, HP-B3, HP-REI, SQM, SQ Change, GID (LCAS) AU4-VC4-Xv, AU3-VC3-Xv: 1st MFI, 2nd MFI, CRC8 (LCAS On) AU4-VC3-Xv: LP-B3, LP-REI, 1st MFI, 2nd MFI, CRC8 (LCAS On) VC12-Xv, VC11-Xv: BIP2, LP-REI, MFI, CRC3 (LCAS On) Insert into multiple specified members at HO/LO VCAT	
Error Addition Timing	Single, Rate, All, Alternate, Rate: Fix Rate: 1×10^{-n} (n: 3 to 9), User Program: A $\times 10^{-B}$ (A: 1.0 to 9.9, B: 2 to 10) Alternative: Error Frame: 0 to 64000, Normal Frame: 1 to 64000	
Alarm Addition	Contiguous Concatenation LOS, LOF, MS-AIS, MS-RDI, AU-AIS, AU-LOP, HP-RDI, HP-UNEQ, HP-SLM Virtual Concatenation LOS, LOF, RS-TIM, MS-AIS, MS-RDI, AU-AIS, AU-LOP, HP-RDI, HP-SLM, HP-TIM, HP-UNEQ, HP-SLM, VCAT-LOM, SQNC: (HOVCAT) AU4-VC3-Xv: TU-AIS, TU-LOP, LP-RID, LP-TIM, LP-UNEQ, LP-SLM VC12-Xv, VC11-Xv: TU-AIS, TU-LOP, TU-LOM, LP-RDI, LP-SLM, LP-UNEQ, VCAT-LOM: (LOVCAT) Insert into multiple specified members at HO/LO VCAT	
Alarm Addition Timing	Alternative, All, Burst (1 to 64000), Single Alternative: Error Frame: 0 to 64000, Normal Frame: 1 to 64000	
Path Monitor	Monitor errors, alarms and other states of each VCG member Summary Window: CH, HP (AU), AU PJC, LP (TU), TU PJC, VCAT, VCAT/LCAS (LCAS On), LCAS/State (LCAS On: OK, FAIL, IDLE, Unknown) Detail window for each VCG member HP (AU): AIS, LOP, RDI, UNEQ, SLM, B3, REI AU PJC: NDF, +PJC, -PJC VCAT/LCAS: LOM, SQM, GID (LCAS On), AU4-VC4-Xv/AU3-VC3-Xv: VCAT, VCAT/LCAS: OOM1, OOM2, CRC8 (LCAS On) AU4-VC3-Xv: LP (TU): AIS, LOP, RDI, UNEQ, SLM, B3, REI TU PJC: NDF, +PJC, -PJC VCAT/LCAS: OOM1, OOM2, CRC8 (LCAS On) VC12-Xv, VC11-Xv: LP (TU): LOM, AIS, LOP, RDI, RFI, UNEQ, SLM, BIP2, REI TU PJC: NDF, +PJC, -PJC VCAT/LCAS: OOM, CRC3 (LCAS On) Detail window for All Ch VCAT: LOA VCAT/LCAS (LCAS On): MND, PLCT, TLCT, PLCR, TLCR, SQNC Following Mapping display items for different alarms and errors • Frame Mapped GFP GFP: Server Signal Fail, Client Loss of Sync, Client Loss of Signal, cHEC Error, tHEC Error, eHEC Error, GFP FCS Error Ethernet/IP: Ethernet Size or FCS Error, IPv4 Header Checksum Error, TCP Checksum Error, UDP Checksum Error • PPP, CiscoHDLC, MAPOS Version 1, MAPOS16 PPP: Aborted Frame, PPP Size or FCS Error Ethernet/IP: IPv4 Header Checksum Error, TCP Checksum Error, UDP Checksum Error • LEX LEX: Aborted Frame, PPP Size or FCS Error Ethernet/IP: Ethernet Size or FCS Error, IPv4 Header Checksum Error, TCP Checksum Error, UDP Checksum Error • LAPS (X.86): LAPS: Aborted Frame, LAPS FCS Error • Bulk: Pattern Sync. Loss, Bit Info.	

• MU150101A-13 LCAS

Sequence Generation	Number of sequence: 64 Command (Title): ADD, Remove, Tmp. Remove, User CTRL value: IDEL, ADD, NORM, DNU, REMOVE, EOS	Timing: Seq. Gap, Send time Time out: 1 to 8,000 multi frames Send Time: 1 to 8,000 multi frames Two or more channels selected as command target channels
Negotiation Setting	MST and RS-Ack values set in USER command mode On/Off On: Wait Time (1 to 8000 Multi-frames) At MST-Fail Rx, either can select convert Tx CTRL signal to DNU or send IDLE as is Select Available/Unavailable for each member Off: Select OK/Fail at Tx MST at each member	
Source/Sink Summary	Displays LCAS status and differential delay for source and sink sides on one screen. Mode: Detail/State Scope: VCG Member Display Item Source Side Detail/State: PLCT, TLCT, XMT, XPT, XAT, Rs-Ack (for Rx) UMST Detail: Ch, State, SQ, Ctrl, MST (For Rx) Differential Delay State: Channel position and state (CTRL) of Tx VCG members Sink Side Detail/State: PLCR, TLCR, MND, SQNC, XMR, XPR, XAR, Rs-Ack (For Tx) Detail: Ch, State, SQ, Ctrl, Differential Delay, LOM, SQM, GID State: Channel position and state (CTRL) of Rx VCG members Alarm Signal: PLCT, TLCT, UMST, PLCR, TLCR, MND, SQNC, LOM, SQM, GID	
Monitor	SQ, CH, CTRL, RS-Ack (Invert or Not), MST condition (can select SQ)	
Capture	OH: H4/K4 Trigger: Change value of SQ/CTRL/MST/RS-Ack, External Trigger Position: 1 to 64 Display: SQ, CTRL, RS-Ack, MST Sequence: Move to next sequence when detect change of CTRL value, MST value, RS-Ack value of selected member Maximum Number of Sequence: 64 (1 to 8000 Multi-frames per sequence)	

• MU150101A-14 Differential Delay

Differential Delay Measurement	Group Delay (ms), Path Trace Table View : CH, SQ, MF, Pointer, Δt (ms), State (Earliest, Latest) Sort by CH or SQ or Δt (ms) is possible. Chart View : Display Δt as graph and zoom and output as bitmap or metafile Sort by CH or SQ or Δt (ms) is possible.	
Differential Delay Addition	Generation range: 0 to 512 ms Equalization range: 0 to 256 ms NDF (MFI, Pointer), +PJC and -PJC set independently for each VCG member Sweep Function Target: Set two A and B points at each VCG member Target Delay Setting: MFI, Pointer Sweep Sequence: Sequentially for each specified VCG member or simultaneously for specified VCG members Sweep Mode: to A, to B, to A to B, to A to B to A Repeat: 1 to 99 (to A to B to A mode only) PJC Interval: 4 to 8000 frames Sweep Priority: AU or TU (AU4-VC3-Xv, AU4/3-VC12-Xv, AU4/3-VC11-Xv only) Estimated Time, Elapsed Time displays Tx Delay Parameters (Present Value): Ch, MFI, Pointer (AU, TU), Δt, Group Delay Rx Delay Parameters: Ch, SQ, MFI, Pointer (AU, TU), Δt, Group Delay, State (Earliest, Latest) NDF, SS: Set shared NDF value and SS values for all members	

• MU150121A 10/10.7G Optical Unit (Tx)

• MU150121B 10/10.7G Optical/Electrical Unit (Tx)

Bit Rate	9953.28 Mbit/s, 10312.5 Mbit/s (MU150121B Only), 10709.225 Mbit/s Accuracy: Depends on frequency accuracy of MU150110A and external input frequency Requires MU150110A-008 at 10312.5 Mbit/s	
Optical Output	Peak Wavelength: 1310 nm ±20 nm (Option-01, 03) 1550 nm ±20 nm (Option-02, 03) Spectrum Range: ≤0.5 nm (@-20 dB) Side Mode Suppression Ratio: ≥30 dB Extinction Ratio: ≥10 dB	Output Power MU150121A: 0 to +3 dBm MU150121B: -1 to +3 dBm Code: NRZ Connector: FC-PC (SMF) Replaceable
Electrical Input (Data, Clock)	Input Level Data H: -0.2 to 0 V, L: -1.5 to -0.85 V Clock 0.6 to 1.3 Vp-p	Code: NRZ Impedance: 50 Ω Connector: SMA
Electrical Differential Output (Data, /Data) (MU150121B Only)	Output Level: Variable (See next item.) Tr/Tf: 25 ps (typ.) Compliant with SDH VC4-64c, SONET STS192c, PRBS 2 ²³ - 1 patterns	Data, /Data Phase Difference: ≤10 psec Code: NRZ Impedance: 50 Ω Connector: SMA
Variable Electrical Differential Output (MU150121B Only)	Variable Range: 150 to 550 mVp-p (Single) Simultaneously variable Data, and /Data	Step: 10 mV Voh: 0 V
Variable Optical Attenuator (Option-04)	Variable Range: 0 to 20 dB Accuracy: ≤±0.5 dB (0 to 10 dB), ≤±1.0 dB (10.1 to 20 dB) Setting Resolution: 0.1 dB	
Laser Safety	IEC 60825-1: 2007: CLASS 1, 21CFR1040.10*	

*: Excludes deviations caused by conformance to Laser Notice No. 50 dated June 24, 2007

Safety measures for laser products

This product complies with optical safety standards in 21CFR1040.10 and IEC 60825-1; the following descriptive labels are affixed to the product.



- MU150123A 10/10.7G Optical Unit (Rx Wide)
- MU150123B 10/10.7G Optical/Electrical Unit (Rx Wide)

Bit Rate	9953.28 Mbit/s ±100 ppm, 10312.5 Mbit/s ±100 ppm*1 (only BER measurement), 10709.225 Mbit/s ±100 ppm*2									
Optical Input	Wavelength: 1260 nm to 1610 nm Sensitivity: -14 to 0 dBm Absolute Maximum Optical Input: +3 dBm (average) Code: NRZ Return Loss: ≥27 dB Connector: FC-PC (SMF), Replaceable									
Electrical Output (for BER, Jitter Measurement)	Data Output: Output Level: MU150123A: 1.0 ±0.25 Vp-p MU150123B: H: -0.2 to 0 V, L: -1.25 to -0.75 V Connector: SMA, 50 Ω Code: NRZ Clock Output Output Level: 0.8 ±0.25 Vp-p Connector: SMA, 50 Ω (AC)									
Electrical Output*1 (for O/E Data)	Output Level: 0.35 Vp-p ±0.15 V (@Optical Input Power: -12 to -10 dBm) Connector: SMA, 50 Ω (AC)									
Electrical Differential Input*1 (Data, /Data)	Input Level (BER Measurement): Differential: 50 to 550 mVp-p Single End: 100 to 550 mVp-p (Jitter Measurement): Differs with measurement conditions. See each item. Phase Difference Tolerance of Data, /Data: ±15 psec Measurement Condition MU150110A/MU150121B (Differential Loop-back Measurement)*2 Jitter Off Test Pattern: SDH VC4-64c, SONET STS192c, Test Pattern 2 ²³ - 1 OTU2-ODU2-OPU2-PRBS (2 ³¹ - 1) Connector: SMA, 50 Ω (AC)									
Variable Electrical Input Threshold*1	Variable H/L evaluation threshold value for electrical differential input data Only valid for single-end use Variable Range: ±50 mV Step: 1 mV									
Intrinsic Jitter	System Measurement (with MU150121A/B)									
	Bit Rate (Mbit/s)	Interface	Jitter Amplitude						UIrms	
			HP1+LP		HP'+LP		HP2+LP		HP'+LP	
		Framed	Unframed*1	Framed	Unframed*1	Framed	Unframed*1	Framed	Unframed*1	
9953.28	Optical Electrical*1	0.08	0.09	0.08	0.09	0.06	0.075	0.006*1/0.009	0.006	
10709.23*2	Optical Electrical*2	0.045		0.045		0.045		0.006		
	Measurement Condition Temperature Range: 10° to 40°C Optical Input Level: -12 to -10 dBm Electrical Input Level: 200 to 500 mVp-p Measurement Time: 60 s Unit Configuration: Optical Interface (Loop-back Measurement)*2 Electrical Interface (Differential Loop-back Measurement)*2 MU150123A + MU150110A/MU150121A/MU150125A MU150123B + MU150110A/MU150121B/MU150125A Optical Input Wavelength: 1310 nm/1550 nm Test Pattern: SDH VC4-64c, SONET STS192c, Test Pattern PRBS 2 ²³ - 1 OTU2-ODU2-OPU2-PRBS (PRBS 2 ³¹ - 1) No Frame (PRBS 2 ²³ - 1) Extinction Ratio: ≥8.2 dB									
	Receiver Measurement					Measurement Condition Temperature Range: 20° to 30°C Electrical Input Amplitude: 200 to 500 mVp-p Measurement time: 60 s Transmitter: Anritsu Reference Transmitter Test Pattern: O.172 Appendix VIII See page 20 for frame formats				
	Bit Rate (Mbit/s)	Interface	Jitter Amplitude			UIrms				
			UIp-p		UIrms					
			HP1+LP	HP'+LP	HP2+LP	HP'+LP				
9953.28	Electrical*1		0.02		0.004					
10709.225*2	Electrical*2									
Random Jitter	Measurement Condition Temperature Range: 10° to 40°C Optical Input Level: -12 to -10 dBm Measurement Time: 60 s Unit Configuration: Optical Interface (Loop-back Measurement)*2, MU150123A/B + MU150110A/MU150121A/B/MU150125A Optical Input Wavelength: 1550 nm Test Pattern: Word16 ""1010101010101010"" (binary) Calculation Method (1) Set filter to HP1+LP and measure for 60 s by MU150125A Clock Loop-back. (2) Set filter to HP1+LP and measure for 60 s by MU150123A/B + MU150110A/MU150121A/B or MU150125A Optical Interface Loop-back. (3) Find difference of measurement results of (1) and (2). The value Obtained by (3) is Value of Random Jitter.									
		Bit Rate (Mbit/s)	Interface	Jitter Amplitude						
				UIp-p						
			HP1+LP							
9953.28		Optical								
10709.225*2		Optical					≤0.010			

Jitter Tolerance	<table border="1"> <tr> <th rowspan="2">Bit Rate (Mbit/s)</th> <th>A1</th> <th>A2</th> <th>A3</th> <th>f6</th> <th>f7</th> <th>f1</th> <th>f2</th> <th>f3</th> <th>f4</th> </tr> <tr> <th colspan="3">Ulp-p</th> <th colspan="6">Hz</th> </tr> <tr> <td>9953.28</td> <td>0.2</td> <td>2</td> <td>3200</td> <td>10</td> <td>12.1</td> <td>20k</td> <td>400k</td> <td>4M</td> <td>80M</td> </tr> <tr> <td>10709.225*2</td> <td></td> <td></td> <td></td> <td></td> <td></td> <td></td> <td></td> <td></td> <td></td> </tr> </table>	Bit Rate (Mbit/s)	A1	A2	A3	f6	f7	f1	f2	f3	f4	Ulp-p			Hz						9953.28	0.2	2	3200	10	12.1	20k	400k	4M	80M	10709.225*2										
	Bit Rate (Mbit/s)		A1	A2	A3	f6	f7	f1	f2	f3	f4																														
Ulp-p			Hz																																						
9953.28	0.2	2	3200	10	12.1	20k	400k	4M	80M																																
10709.225*2																																									
<p>Measurement Condition</p> <p>Temperature Range: 10° to 40°C</p> <p>Optical Input Level: -12 to -10 dBm</p> <p>Electrical Input Level: 150 to 500 mVp-p</p> <p>Measurement Time: 60 s</p> <p>Unit Configuration: Optical Interface (Loop-back Measurement)*2</p> <p>Electrical Interface (Differential Loop-back Measurement)*2</p> <p>MU150123B + MU150110A/MU150121B/MU150125A</p> <p>Optical Input Wavelength: 1310 nm/1550 nm</p> <p>Test Pattern: SDH VC4-64c, SONET STS192c, Test Pattern PRBS 2²³ - 1</p> <p>OTU2-ODU2-OPU2-PRBS (PRBS 2²³ - 1)</p>																																									
Optical Input Power Measurement	<p>Measurement Range: -20 to +2 dBm</p> <p>Measurement Accuracy</p> <p>MU150123A: ≤±0.5 dB (-10 to +2 dBm), ≤±1.0 dB (-20 to -10.1 dBm)</p> <p>MU150123B: ≤±0.5 dB (-10 to -1.1 dBm), ≤±1.0 dB (-1.0 to +2 dBm, -20 to -10.1 dBm)</p>																																								

*1: MU150123B only

*2: Requires MU150123A/B Option-05 for 10709M.

• MU150124B 10.3G Optical/Electrical Unit (Rx Wide)

Bit Rate	9953.28 Mbit/s ±100 ppm (BER measurement only), 10312.5 Mbit/s ±100 ppm, 10709.225 Mbit/s ±100 ppm (BER measurement only)																														
Optical Input	<p>Wavelength: 1260 nm to 1610 nm</p> <p>Sensitivity: -14 to 0 dBm</p> <p>Absolute Maximum Optical Input: +3 dBm (average)</p> <p>Code: NRZ</p> <p>Return Loss: ≥27 dB</p> <p>Connector: FC-PC (SMF), Replaceable</p>																														
Electrical Output (for BER, Jitter Measurement)	<p>Data Output</p> <p>Output Level: H: -0.2 to 0 V, L: -1.25 to -0.75 V</p> <p>Connector: SMA, 50 Ω</p> <p>Code: NRZ</p> <p>Clock Output (Wide/Narrow)</p> <p>At 10312.5 MHz ±100 ppm.</p> <p>Output Level: 0.8 ±0.25 Vp-p</p> <p>Connector: SMA, 50 Ω (AC)</p>																														
Electrical Output (O/E Data)	Output Level: 0.35 Vp-p ±0.15 V (Optical Input Power: -12 to -10 dBm) Connector: SMA, 50 Ω (AC)																														
Electrical Differential Input (Data, $\sqrt{\text{Data}}$)	<p>Input Level (BER measurement): Differential: 50 to 550 mVp-p (× 2)</p> <p>Single End Use: 100 to 550 mVp-p</p> <p>(Jitter measurement): Varies with measurement conditions. See each item.</p> <p>Data, $\sqrt{\text{Data}}$ Phase Difference Tolerance: ±15 ps</p> <p>Measurement Condition</p> <p>MU150110A/MU150121B (Differential Loop-back Measurement)</p> <p>Jitter Off</p> <p>Test Pattern: No Frame (PRBS 2³¹ - 1)</p> <p>Connector: SMA, 50 Ω (AC)</p>																														
Variable Electrical Input Threshold	<p>Variable Electrical Differential Input Data H/L Evaluation Threshold Value</p> <p>Single End only</p> <p>Variable Range: ±50 mV</p> <p>Step: 1 mV</p>																														
Intrinsic Jitter	<table border="1"> <tr> <th rowspan="3">Bit Rate (Mbit/s)</th> <th rowspan="3">Interface</th> <th colspan="4">Jitter Amplitude</th> </tr> <tr> <th colspan="4">Ulp-p</th> </tr> <tr> <th>HP1+LP</th> <th>HP'+LP</th> <th>HP2+LP</th> <th>HP'+LP</th> </tr> <tr> <td>10312.5 Wide</td> <td>Optical</td> <td>0.09</td> <td></td> <td>0.075</td> <td>0.006</td> </tr> <tr> <td>10312.5 Narrow</td> <td>Optical</td> <td>0.04</td> <td></td> <td>0.03</td> <td>0.005</td> </tr> </table>	Bit Rate (Mbit/s)	Interface	Jitter Amplitude				Ulp-p				HP1+LP	HP'+LP	HP2+LP	HP'+LP	10312.5 Wide	Optical	0.09		0.075	0.006	10312.5 Narrow	Optical	0.04		0.03	0.005	<p>Measurement Condition</p> <p>Temperature Range: 10° to 40°C</p> <p>Optical Input Level: -12 to -10 dBm</p> <p>Electrical Input Level: 200 to 500 mVp-p</p> <p>Measurement Time: 60 s</p> <p>Unit Configuration: Optical Interface (Loop-back Measurement), Electrical interface (Differential Loop-back Measurement)</p> <p>MU150124B + MU150110A/MU150121B/MU150125A</p> <p>Optical Input Wavelength: 1310 nm/1550 nm</p> <p>Test Pattern: No Frame (PRBS 2²³ - 1)</p> <p>Extinction Ratio: ≥8.2 dB</p>			
Bit Rate (Mbit/s)	Interface			Jitter Amplitude																											
				Ulp-p																											
		HP1+LP	HP'+LP	HP2+LP	HP'+LP																										
10312.5 Wide	Optical	0.09		0.075	0.006																										
10312.5 Narrow	Optical	0.04		0.03	0.005																										
Jitter Tolerance	<table border="1"> <tr> <th rowspan="2">Bit Rate (Mbit/s)</th> <th>A1</th> <th>A2</th> <th>A3</th> <th>f6</th> <th>f7</th> <th>f1</th> <th>f2</th> <th>f3</th> <th>f4</th> </tr> <tr> <th colspan="3">Ulp-p</th> <th colspan="6">Hz</th> </tr> <tr> <td>10312.5</td> <td>0.2</td> <td>2</td> <td>3200</td> <td>10</td> <td>12.1</td> <td>20k</td> <td>400k</td> <td>4M</td> <td>80M</td> </tr> </table>	Bit Rate (Mbit/s)	A1	A2	A3	f6	f7	f1	f2	f3	f4	Ulp-p			Hz						10312.5	0.2	2	3200	10	12.1	20k	400k	4M	80M	
Bit Rate (Mbit/s)	A1		A2	A3	f6	f7	f1	f2	f3	f4																					
	Ulp-p			Hz																											
10312.5	0.2	2	3200	10	12.1	20k	400k	4M	80M																						
<p>Measurement Condition</p> <p>Temperature Range: 10° to 40°C</p> <p>Optical Input Level: -12 to -10 dBm</p> <p>Electrical Input Level: 150 to 500 mVp-p</p> <p>Measurement Time: 60 s</p> <p>Unit Configuration: Optical Interface (Loop-back Measurement), Electrical interface (Differential Loop-back Measurement)</p> <p>MU150124B + MU150110A/MU150121B/MU150125A</p> <p>Optical Input Wavelength: 1310 nm/1550 nm</p> <p>Test Pattern: No Frame (PRBS 2²³ - 1)</p>																															
Optical Input Power Measurement	<p>Measurement Range: -20 to +2 dBm</p> <p>Measurement Accuracy: ≤±0.5 dB (-10 to -1.1 dBm), ≤±1.0 dB (-1.0 to +2 dBm, -20 to -10.1 dBm)</p>																														

• MU150125A 10/10.7G Jitter Unit

Jitter Generation/ Measurement Frequency	51.84 MHz, 155.52 MHz, 622.08 MHz, 2488.32 MHz, 9953.28 MHz, 2666.06 MHz (MU150125A-05), 10709.225 MHz (MU150125A-05), 10312.5 MHz (MU150125A-06)
10/10.3/10.7G Clock Output 52 MHz to 2.66 GHz Clock Output	Frequency: 51.84 MHz ±100 ppm, 155.52 MHz ±100 ppm, 622.08 MHz ±100 ppm, 2488.32 MHz ±100 ppm, 2666.057 MHz ±100 ppm, 9953.28 MHz ±100 ppm, 10312.5 MHz ±100 ppm, 10709.225 MHz ±100 ppm Accuracy: ±0.1 ppm [After power-on, calibrated after 24 hours at, warm-up of 23' ±5' C, aging rate (max.): ±0.05 ppm/day, ±0.5 ppm/year] Level: 0.8 Vp-p ±0.25 V Connector: SMA, 50 Ω (AC)

Modulation Frequency: 0.1 Hz to 80 MHz
Amplitude: 0 to 4040 Ulp-p
Modulation Value:
52M, 156M, 622M

Frequency (Hz)	f0 (Hz)	f1 (kHz)	f2 (kHz)	f3 (kHz)	f4 (kHz)	f5 (MHz)	A0 (Ulp-p)	A1 (Ulp-p)	A2 (Ulp-p)	A3 (Ulp-p)	A4 (Ulp-p)
52M	0.1	—	—	50	500	1.3	0.776	2.02	20.20	80.8	253.0
155M		38	150	1500	3.8	0.797					
622M		4.8	15	60	600	5	0.242				

2488M, 2666M

Frequency (Hz)	f0 (Hz)	f1 (Hz)	f2 (kHz)	f3 (kHz)	f4 (kHz)	f5 (MHz)	f6 (MHz)	f7 (MHz)	A1 (Ulp-p)	A2 (Ulp-p)	A3 (Ulp-p)	A4 (Ulp-p)	A5 (Ulp-p)
2488M	0.1	15	600	100	500	1	4	20	0.505	2.02	20.2	25	1010
2666M													

9953M, 10.3G, 10.7G

Frequency (Hz)	f0 (Hz)	f1 (Hz)	f2 (kHz)	f3 (kHz)	f4 (kHz)	f5 (MHz)	f6 (MHz)	f7 (MHz)	A1 (Ulp-p)	A2 (Ulp-p)	A3 (Ulp-p)	A4 (Ulp-p)	A5 (Ulp-p)	A6 (Ulp-p)
9953M	0.1	15	600	100	500	1	4	80	0.505	2.02	8.08	80.8	110	4040
10.3G														
10.7G														

Frequency	Variable Error Q	Frequency Range
52 MHz	±8%	0.1 kHz to 500 kHz
	±12%	500 kHz to 1.3 MHz
156 MHz	±8%	0.1 kHz to 500 kHz
	±12%	500 kHz to 1.5 MHz
	±15%	1.5 MHz to 3.8 MHz
622 MHz	±8%	0.1 kHz to 500 kHz
	±12%	500 kHz to 2 MHz
	±15%	2 MHz to 5 MHz
2488 MHz 2666 MHz	±8%	0.1 kHz to 500 kHz
	±12%	500 kHz to 2 MHz
	±15%	2 MHz to 20 MHz
9953 MHz 10.3 GHz 10.7 GHz	±8%	0.1 kHz to 500 kHz
	±12%	500 kHz to 2 MHz
	±15%	2 MHz to 80 MHz

Accuracy:
0.5 UI Range: ±Q% of Setting ±0.02 Ulp-p
2 UI Range: ±Q% of Setting ±0.02 Ulp-p
8 UI Range: ±Q% of Setting ±0.08 Ulp-p
20 UI Range: ±Q% of Setting ±0.2 Ulp-p
80 UI Range: ±Q% of Setting ±0.8 Ulp-p
250 UI Range: ±Q% of Setting ±2.5 Ulp-p
1000 UI Range: ±Q% of Setting ±10 Ulp-p
4000 UI Range: ±Q% of Setting ±40 Ulp-p

10/10.3/10.7G Clock Input 52 MHz to 2.66 GHz Clock Input	Frequency: 51.84 MHz ±100 ppm, 155.52 MHz ±100 ppm, 622.08 MHz ±100 ppm, 2488.32 MHz ±100 ppm, 2666.057 MHz ±100 ppm, 9953.28 MHz ±100 ppm, 10312.5 MHz ±100 ppm, 10709.225 MHz ±100 ppm Level: 0.8 Vp-p ±0.3 V (52 MHz to 2.6 GHz), 0.8 Vp-p ±0.25 V (10/10.3/10.7 GHz) Connector: SMA, 50Ω (AC)																																																																																																				
Jitter Measurement	Manual Jitter Measurement: Ulp-p, UI+p, UI-p/Urms Ulp-p Measurement: 2 UI Range (-1.010 to 1.010 Ulp-p/Step 0.001 Ulp-p) 20 UI Range (-10.10 to 10.10 Ulp-p/Step 0.01 Ulp-p) 80 UI Range (-40.4 to 40.4 Ulp-p/Step 0.25 Ulp-p) 250 UI Range (-123.0 to 123.0 Ulp-p/Step 0.5 Ulp-p) 1000 UI Range (-510.0 to 510.0 Ulp-p/Step 1 Ulp-p) 4000 UI Range (-2020 to 2020 Ulp-p/Step 2 Ulp-p) Urms Measurement: 2 UI Range (0.000 to 0.714 Urms/Step 0.001 Urms) 20 UI Range (0.00 to 7.14 Urms/Step 0.01 Urms) Measurement Filter <table border="1" data-bbox="901 346 1468 567"> <thead> <tr> <th>Frequency (Hz)</th> <th>HP0 (Hz)</th> <th>HP1 (Hz)</th> <th>HP1' (Hz)</th> <th>HP2 (Hz)</th> <th>HP' (Hz)</th> <th>HP (Hz)</th> <th>LP (Hz)</th> <th>LP' (Hz)</th> </tr> </thead> <tbody> <tr> <td>52M</td> <td rowspan="6">10</td> <td>100</td> <td></td> <td>20k</td> <td></td> <td rowspan="6">12k</td> <td>400k</td> <td>-</td> </tr> <tr> <td>156M</td> <td>500</td> <td></td> <td>65k</td> <td></td> <td>1.3M</td> <td>500</td> </tr> <tr> <td>622M</td> <td>1k</td> <td>-</td> <td>250k</td> <td>-</td> <td>5M</td> <td>1k</td> </tr> <tr> <td>2488M</td> <td>5k</td> <td></td> <td>1M</td> <td></td> <td>20M</td> <td>5k</td> </tr> <tr> <td>2666M</td> <td></td> <td></td> <td></td> <td></td> <td></td> <td></td> </tr> <tr> <td>9953M</td> <td>20k</td> <td>10k</td> <td>4M</td> <td>50k</td> <td>80M</td> <td>20k</td> </tr> <tr> <td>10.3G</td> <td></td> <td></td> <td></td> <td></td> <td></td> <td></td> </tr> <tr> <td>10.7G</td> <td></td> <td></td> <td></td> <td></td> <td></td> <td></td> </tr> </tbody> </table>	Frequency (Hz)	HP0 (Hz)	HP1 (Hz)	HP1' (Hz)	HP2 (Hz)	HP' (Hz)	HP (Hz)	LP (Hz)	LP' (Hz)	52M	10	100		20k		12k	400k	-	156M	500		65k		1.3M	500	622M	1k	-	250k	-	5M	1k	2488M	5k		1M		20M	5k	2666M							9953M	20k	10k	4M	50k	80M	20k	10.3G							10.7G																																							
	Frequency (Hz)	HP0 (Hz)	HP1 (Hz)	HP1' (Hz)	HP2 (Hz)	HP' (Hz)	HP (Hz)	LP (Hz)	LP' (Hz)																																																																																												
	52M	10	100		20k		12k	400k	-																																																																																												
156M	500			65k		1.3M		500																																																																																													
622M	1k		-	250k	-	5M		1k																																																																																													
2488M	5k			1M		20M		5k																																																																																													
2666M																																																																																																					
9953M	20k		10k	4M	50k	80M		20k																																																																																													
10.3G																																																																																																					
10.7G																																																																																																					
Accuracy (Ulp-p, UI+p, UI-p) 2 UI Range: ±R% ±W Ulp-p 20 UI Range: ±R% ±W Ulp-p 80 UI Range: ±R% ±W Ulp-p 250 UI Range: ±R% ±W Ulp-p 1000 UI Range: ±R% ±W Ulp-p 4000 UI Range: ±R% ±W Ulp-p Accuracy (Urms) 2 UI range: ±R% ±Y UI rms 20 UI range: ±R% ±Y UI rms *: Using HP'+LP at 9953M, 10.3G, 10.7G <table border="1" data-bbox="774 598 1468 945"> <thead> <tr> <th rowspan="3">Frequency (Hz)</th> <th colspan="6">W Clock Signal</th> <th colspan="2">Y Clock Signal</th> </tr> <tr> <th colspan="8">Ulp-p</th> </tr> <tr> <th colspan="2">HP1+LP</th> <th colspan="2">HP2+LP</th> <th colspan="2">HP+LP*</th> <th colspan="2">HP0+LP'</th> </tr> <tr> <td></td> <td>2 UI</td> <td>20 UI</td> <td>2 UI</td> <td>20 UI</td> <td>2 UI</td> <td>20 UI</td> <td>80UI 250 UI 1000 UI 4000 UI</td> <td>2 UI</td> <td>20 UI</td> </tr> </thead> <tbody> <tr> <td>52M</td> <td>0.035</td> <td>0.5</td> <td>0.03</td> <td>0.3</td> <td rowspan="6">0.03</td> <td rowspan="6">0.3</td> <td>-</td> <td>0.08</td> <td>0.04</td> </tr> <tr> <td>156M</td> <td>0.035</td> <td>0.5</td> <td>0.02</td> <td>0.2</td> <td>2</td> <td>0.08</td> <td>0.04</td> </tr> <tr> <td>622M</td> <td>0.035</td> <td>0.5</td> <td></td> <td></td> <td>8</td> <td>0.08</td> <td>0.04</td> </tr> <tr> <td>2488M</td> <td>0.035</td> <td>0.5</td> <td>0.03</td> <td>0.3</td> <td>20</td> <td>0.08</td> <td>0.04</td> </tr> <tr> <td>2666M</td> <td></td> <td></td> <td></td> <td></td> <td></td> <td></td> <td></td> </tr> <tr> <td>9953M</td> <td>0.035</td> <td>0.5</td> <td></td> <td></td> <td>80</td> <td>0.01</td> <td>0.05</td> </tr> <tr> <td>10.3G</td> <td></td> <td></td> <td></td> <td></td> <td></td> <td></td> <td></td> </tr> <tr> <td>10.7G</td> <td></td> <td></td> <td></td> <td></td> <td></td> <td></td> <td></td> </tr> </tbody> </table>	Frequency (Hz)	W Clock Signal						Y Clock Signal		Ulp-p								HP1+LP		HP2+LP		HP+LP*		HP0+LP'			2 UI	20 UI	2 UI	20 UI	2 UI	20 UI	80UI 250 UI 1000 UI 4000 UI	2 UI	20 UI	52M	0.035	0.5	0.03	0.3	0.03	0.3	-	0.08	0.04	156M	0.035	0.5	0.02	0.2	2	0.08	0.04	622M	0.035	0.5			8	0.08	0.04	2488M	0.035	0.5	0.03	0.3	20	0.08	0.04	2666M								9953M	0.035	0.5			80	0.01	0.05	10.3G								10.7G							
Frequency (Hz)		W Clock Signal						Y Clock Signal																																																																																													
		Ulp-p																																																																																																			
	HP1+LP		HP2+LP		HP+LP*		HP0+LP'																																																																																														
	2 UI	20 UI	2 UI	20 UI	2 UI	20 UI	80UI 250 UI 1000 UI 4000 UI	2 UI	20 UI																																																																																												
52M	0.035	0.5	0.03	0.3	0.03	0.3	-	0.08	0.04																																																																																												
156M	0.035	0.5	0.02	0.2			2	0.08	0.04																																																																																												
622M	0.035	0.5					8	0.08	0.04																																																																																												
2488M	0.035	0.5	0.03	0.3			20	0.08	0.04																																																																																												
2666M																																																																																																					
9953M	0.035	0.5					80	0.01	0.05																																																																																												
10.3G																																																																																																					
10.7G																																																																																																					
MU150110A Loop-back Measurement (*: MU150125A-05 installed) Measurement Condition Temperature Condition: 10° to 40°C Optical Input Level: -12 to -10 dBm Measurement Time: 60 s Optical Input Wavelength: 1310 nm/1550 nm Mapping SDH: VC3-Bulk (52M), VC4-nc (n = 1, 4, 16) (156M/622M/2488M) SONET: STSnc (n = 1, 3, 12, 48) OTU1: ODU1-OPU1-PRBS Test Pattern: PRBS 2 ²³ - 1 (Inv.) (SDH/SONET), PRBS 2 ³¹ - 1 (OTU1), Mark Ratio 1/2, Scramble On Clock: Internal <table border="1" data-bbox="893 1018 1468 1291"> <thead> <tr> <th rowspan="3">Bit Rate (Mbit/s)</th> <th colspan="3">W Data Signal</th> <th>Y Data Signal</th> </tr> <tr> <th colspan="4">Ulp-p</th> </tr> <tr> <th>HP1+LP</th> <th>HP+LP</th> <th>HP2+LP</th> <th>HP+LP</th> </tr> <tr> <td></td> <td colspan="4">2 UI</td> </tr> </thead> <tbody> <tr> <td>51.84 (Optical)</td> <td rowspan="6">0.070</td> <td rowspan="6">0.035</td> <td rowspan="6">0.010</td> <td rowspan="6">0.010</td> </tr> <tr> <td>51.84 (Electrical)</td> </tr> <tr> <td>155.52 (Optical)</td> </tr> <tr> <td>155.52 (Electrical)</td> </tr> <tr> <td>622.08 (Optical)</td> </tr> <tr> <td>2488.32 (Optical)</td> </tr> <tr> <td>2666.05 (Optical)*</td> <td>0.080</td> <td>0.060</td> <td></td> <td></td> </tr> </tbody> </table>	Bit Rate (Mbit/s)	W Data Signal			Y Data Signal	Ulp-p				HP1+LP	HP+LP	HP2+LP	HP+LP		2 UI				51.84 (Optical)	0.070	0.035	0.010	0.010	51.84 (Electrical)	155.52 (Optical)	155.52 (Electrical)	622.08 (Optical)	2488.32 (Optical)	2666.05 (Optical)*	0.080	0.060																																																																						
Bit Rate (Mbit/s)		W Data Signal			Y Data Signal																																																																																																
		Ulp-p																																																																																																			
	HP1+LP	HP+LP	HP2+LP	HP+LP																																																																																																	
	2 UI																																																																																																				
51.84 (Optical)	0.070	0.035	0.010	0.010																																																																																																	
51.84 (Electrical)																																																																																																					
155.52 (Optical)																																																																																																					
155.52 (Electrical)																																																																																																					
622.08 (Optical)																																																																																																					
2488.32 (Optical)																																																																																																					
2666.05 (Optical)*	0.080	0.060																																																																																																			
MU150110A with MU150125A Receiver Only (*: MU150125A-05 installed) Measurement Condition Temperature Condition: 10° to 40°C Optical Input Level: -12 to -10 dBm Measurement Time: 60 s Optical Input Wavelength: 1310 nm/1550 nm Mapping SDH: VC3-Bulk (52M), VC4-nc (n = 1, 4, 16) (156M/622M/2488M) SONET: STSnc (n = 1, 3, 12, 48) OTU1: ODU1-OPU1-PRBS Test Pattern: PRBS 2 ²³ - 1 (Inv.) (SDH/SONET), PRBS 2 ³¹ - 1 (OTU1), Mark Ratio 1/2, Scramble On <table border="1" data-bbox="893 1365 1468 1627"> <thead> <tr> <th rowspan="3">Bit Rate (Mbit/s)</th> <th colspan="3">W Data Signal (Typical)</th> <th>Y Data Signal</th> </tr> <tr> <th colspan="4">Ulp-p</th> </tr> <tr> <th>HP1+LP</th> <th>HP+LP</th> <th>HP2+LP</th> <th>HP+LP</th> </tr> <tr> <td></td> <td colspan="4">2 UI</td> </tr> </thead> <tbody> <tr> <td>51.84 (Optical)</td> <td rowspan="6">0.035</td> <td rowspan="6">0.009</td> <td rowspan="6">0.009</td> <td rowspan="6">0.009</td> </tr> <tr> <td>51.84 (Electrical)</td> </tr> <tr> <td>155.52 (Optical)</td> </tr> <tr> <td>155.52 (Electrical)</td> </tr> <tr> <td>622.08</td> </tr> <tr> <td>2488.32</td> </tr> <tr> <td>2666.05*</td> <td></td> <td></td> <td></td> <td></td> </tr> </tbody> </table>	Bit Rate (Mbit/s)	W Data Signal (Typical)			Y Data Signal	Ulp-p				HP1+LP	HP+LP	HP2+LP	HP+LP		2 UI				51.84 (Optical)	0.035	0.009	0.009	0.009	51.84 (Electrical)	155.52 (Optical)	155.52 (Electrical)	622.08	2488.32	2666.05*																																																																								
Bit Rate (Mbit/s)		W Data Signal (Typical)			Y Data Signal																																																																																																
		Ulp-p																																																																																																			
	HP1+LP	HP+LP	HP2+LP	HP+LP																																																																																																	
	2 UI																																																																																																				
51.84 (Optical)	0.035	0.009	0.009	0.009																																																																																																	
51.84 (Electrical)																																																																																																					
155.52 (Optical)																																																																																																					
155.52 (Electrical)																																																																																																					
622.08																																																																																																					
2488.32																																																																																																					
2666.05*																																																																																																					

Jitter Measurement	MU150110A, MU150121A, MU150123A Loop-back Measurement (*: MU150125A-05 installed) Measurement Condition Temperature Condition: 10° to 40°C Optical Input Level: -12 to -10 dBm Measurement Time: 60 s Optical Input Wavelength: 1310 nm/1550 nm Mapping SDH: VC4-64c (9953M) SONET: STS192c (9953M) OTU2: ODU2-OPU2-PRBS	Test Pattern: PRBS 2 ²³ - 1 (Inv.) (SDH/SONET), PRBS 2 ³¹ - 1 (OTU2), Mark Ratio 1/2, Scramble On Clock: Internal																										
	<table border="1"> <thead> <tr> <th rowspan="3">Bit Rate (Mbit/s)</th> <th colspan="2">W Data Signal</th> <th>Y Data Signal</th> </tr> <tr> <th colspan="3">Ulp-p</th> </tr> <tr> <th>HP1+LP</th> <th>HP'+LP</th> <th>HP2+LP</th> </tr> </thead> <tbody> <tr> <td colspan="4" style="text-align: center;">2 UI</td> </tr> <tr> <td>9953.280</td> <td colspan="2" style="text-align: center;">0.080</td> <td style="text-align: center;">0.009</td> </tr> <tr> <td>10709.225*</td> <td colspan="2"></td> <td></td> </tr> </tbody> </table>	Bit Rate (Mbit/s)	W Data Signal		Y Data Signal	Ulp-p			HP1+LP	HP'+LP	HP2+LP	2 UI				9953.280	0.080		0.009	10709.225*								
	Bit Rate (Mbit/s)		W Data Signal		Y Data Signal																							
Ulp-p																												
HP1+LP		HP'+LP	HP2+LP																									
2 UI																												
9953.280	0.080		0.009																									
10709.225*																												
MU150123A with MU150125A Receiver Only (*: MU150125A-05 installed) Measurement Condition Temperature Condition: 10° to 40°C Optical Input Level: -12 to -10 dBm Measurement Time: 60 s Optical Input Wavelength: 1310 nm/1550 nm Mapping SDH: VC4-64c (9953M) SONET: STS192c (9953M) OTU2: ODU2-OPU2-PRBS	Test Pattern: PRBS 2 ²³ - 1 (Inv.) (SDH/SONET), PRBS 2 ³¹ - 1 (OTU2), Mark Ratio 1/2, Scramble On																											
<table border="1"> <thead> <tr> <th rowspan="3">Bit Rate (Mbit/s)</th> <th colspan="2">W Data Signal</th> <th>Y Data Signal</th> </tr> <tr> <th colspan="3">Ulp-p</th> </tr> <tr> <th>HP1+LP</th> <th>HP'+LP</th> <th>HP2+LP</th> </tr> </thead> <tbody> <tr> <td colspan="4" style="text-align: center;">2 UI</td> </tr> <tr> <td>9953.280</td> <td colspan="2" style="text-align: center;">0.035</td> <td style="text-align: center;">0.009</td> </tr> <tr> <td>10709.225*</td> <td colspan="2"></td> <td></td> </tr> </tbody> </table>	Bit Rate (Mbit/s)	W Data Signal		Y Data Signal	Ulp-p			HP1+LP	HP'+LP	HP2+LP	2 UI				9953.280	0.035		0.009	10709.225*									
Bit Rate (Mbit/s)		W Data Signal		Y Data Signal																								
		Ulp-p																										
	HP1+LP	HP'+LP	HP2+LP																									
2 UI																												
9953.280	0.035		0.009																									
10709.225*																												
Frequency Error [R]	<table border="1"> <thead> <tr> <th>Additional Error</th> <th>Frequency Range</th> </tr> </thead> <tbody> <tr> <td rowspan="5">±15%</td> <td><100 Hz (52M)</td> </tr> <tr> <td><500 Hz (156M)</td> </tr> <tr> <td><1 kHz (622M)</td> </tr> <tr> <td><5 kHz (2488M, 2666M)</td> </tr> <tr> <td><20 kHz (9953M/10.3G/10.7G)</td> </tr> <tr> <td rowspan="4">±7%</td> <td>100 Hz to 300 kHz (52M)</td> </tr> <tr> <td>500 Hz to 300 kHz (156M)</td> </tr> <tr> <td>1 kHz to 300 kHz (622M)</td> </tr> <tr> <td>5 kHz to 300 kHz (2488M, 2666M)</td> </tr> <tr> <td rowspan="2">±8%</td> <td>20 kHz to 300 kHz (9953M/10.3G/10.7G)</td> </tr> <tr> <td>300 kHz to 400 kHz (52M)</td> </tr> <tr> <td rowspan="2">±10%</td> <td>300 kHz to 1 MHz (≥156M)</td> </tr> <tr> <td>1 MHz to 1.3 MHz (156M)</td> </tr> <tr> <td rowspan="2">±15%</td> <td>1 MHz to 3 MHz (≥622M)</td> </tr> <tr> <td>3 MHz to 5 MHz (622M)</td> </tr> <tr> <td rowspan="2">±20%</td> <td>3 MHz to 10 MHz (≥2488M)</td> </tr> <tr> <td>10 MHz to 20 MHz (2488M, 2666M)</td> </tr> <tr> <td></td> <td>10 MHz to 80 MHz (9953M/10.3G/10.7G)</td> </tr> </tbody> </table>	Additional Error	Frequency Range	±15%	<100 Hz (52M)	<500 Hz (156M)	<1 kHz (622M)	<5 kHz (2488M, 2666M)	<20 kHz (9953M/10.3G/10.7G)	±7%	100 Hz to 300 kHz (52M)	500 Hz to 300 kHz (156M)	1 kHz to 300 kHz (622M)	5 kHz to 300 kHz (2488M, 2666M)	±8%	20 kHz to 300 kHz (9953M/10.3G/10.7G)	300 kHz to 400 kHz (52M)	±10%	300 kHz to 1 MHz (≥156M)	1 MHz to 1.3 MHz (156M)	±15%	1 MHz to 3 MHz (≥622M)	3 MHz to 5 MHz (622M)	±20%	3 MHz to 10 MHz (≥2488M)	10 MHz to 20 MHz (2488M, 2666M)		10 MHz to 80 MHz (9953M/10.3G/10.7G)
Additional Error	Frequency Range																											
±15%	<100 Hz (52M)																											
	<500 Hz (156M)																											
	<1 kHz (622M)																											
	<5 kHz (2488M, 2666M)																											
	<20 kHz (9953M/10.3G/10.7G)																											
±7%	100 Hz to 300 kHz (52M)																											
	500 Hz to 300 kHz (156M)																											
	1 kHz to 300 kHz (622M)																											
	5 kHz to 300 kHz (2488M, 2666M)																											
±8%	20 kHz to 300 kHz (9953M/10.3G/10.7G)																											
	300 kHz to 400 kHz (52M)																											
±10%	300 kHz to 1 MHz (≥156M)																											
	1 MHz to 1.3 MHz (156M)																											
±15%	1 MHz to 3 MHz (≥622M)																											
	3 MHz to 5 MHz (622M)																											
±20%	3 MHz to 10 MHz (≥2488M)																											
	10 MHz to 20 MHz (2488M, 2666M)																											
	10 MHz to 80 MHz (9953M/10.3G/10.7G)																											

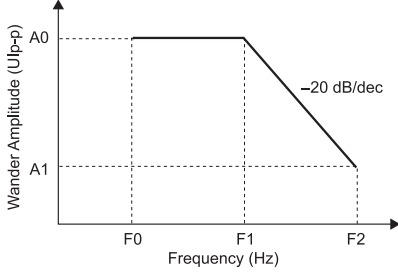
Hit Measurement	Count, Hit Seconds, % Free Seconds																											
Jitter Tolerance	Evaluate Jitter Tolerance by Selected Mask Mask Selection: Telcordia GR-253, ANSI T1.105.03 ITU-T G.783, G.825, G.813, G.8251 ETSI EN 302 084 User																											
Jitter Transfer	Evaluate Jitter Transfer by Selected Mask Accuracy: ± 0.05 dB $\pm 0.12 \times g$ Applicable Frequency Range: 0.01 \times fc to 100 \times fc, or Maximum Frequency Setting Value Maximum Frequency Setting Value used for 100 \times fc g: Transfer Gain (dB) for Every Frequency Point fc: Cut-off Frequency of Transfer Mask Measurement Condition Average Level: Fine Waiting Time: 20 s Input Jitter Value: ≥ 0.15 Ulp-p Jitter Modulation Frequency: ≥ 300 Hz Dynamic Range: ≤ -40 dB (at the above Measurement Condition)	Mask Selection [Modulation frequency of 100 times break point (fc) of mask upper limit]: Telcordia GR-253 ANSI T1.105.03 ITU-T G.783, G.8251 ETSI 300 417-1-1 User																										
Reference Clock Output	Frequency: 52M: 51.84 MHz ± 100 ppm 156M: 155.52 MHz ± 100 ppm 622M: 622.08 MHz ± 100 ppm 2488M/9953M: 155.52 MHz ± 100 ppm or 622.08 MHz ± 100 ppm 2666M: 166.629 MHz ± 100 ppm or 666.514 MHz ± 100 ppm 10.3G: 161.133 MHz ± 100 ppm or 644.531 MHz ± 100 ppm 10.7G: 167.332 MHz ± 100 ppm or 669.327 MHz ± 100 ppm Output Voltage: 0.8 Vp-p ± 0.25 V Connector: SMA, 50 Ω (AC)																											
External Clock Input	Frequency: 52M: 51.84 MHz ± 100 ppm 156M: 155.52 MHz ± 100 ppm 622M: 622.08 MHz ± 100 ppm 2488M/9953M: 155.52 MHz ± 100 ppm or 622.08 MHz ± 100 ppm 2666M: 166.629 MHz ± 100 ppm or 666.514 MHz ± 100 ppm 10.3G: 161.133 MHz ± 100 ppm or 644.531 MHz ± 100 ppm 10.7G: 167.332 MHz ± 100 ppm or 669.327 MHz ± 100 ppm	Level: 0.8 Vp-p ± 0.25 V Connector: SMA, 50 Ω (AC)																										
External Jitter Modulation Signal Input	Frequency: 0.1 Hz to 80 MHz Sensitivity: 0.5 UI range: 2488M/2666M 0.5 Ulp-p/1 Vp-p, 9953M/10.3G/10.7G 0.5 Ulp-p/0.25 Vp-p 2 UI range: 2 Ulp-p/1 Vp-p 20 UI range: 20 Ulp-p/1 Vp-p 80 UI range: 80 Ulp-p/1 Vp-p 250 UI range: 250 Ulp-p/1 Vp-p 1000 UI range: 1000 Ulp-p/1 Vp-p 4000 UI range: 4000 Ulp-p/1 Vp-p	Connector: BNC, 50 Ω (GND)																										
Jitter Recovery Signal Output	Frequency: 10 Hz to 80 MHz (Supports Jitter Demodulation Only) Sensitivity: 2 UI range: 2 Ulp-p/1 Vp-p 20 UI range: 20 Ulp-p/1 Vp-p 80 UI range: 80 Ulp-p/1 Vp-p 250 UI range: 250 Ulp-p/1 Vp-p 1000 UI range: 1000 Ulp-p/1 Vp-p 4000 UI range: 4000 Ulp-p/1 Vp-p	Connector: BNC, 50 Ω (GND)																										
Wander Generation	Modulation Frequency: 10 μ Hz to 10 Hz Amplitude: 0 to 400,000 UI/Step 1 Ulp-p <table border="1" data-bbox="327 1312 949 1465"> <thead> <tr> <th>Frequency (Hz)</th> <th>F0 (Hz)</th> <th>F1 (Hz)</th> <th>F2 (Hz)</th> <th>A0 (Ulp-p)</th> <th>A1 (Ulp-p)</th> <th>Step (Ulp-p)</th> </tr> </thead> <tbody> <tr> <td>52</td> <td rowspan="5">10 μ</td> <td rowspan="5">400 m</td> <td rowspan="5">10</td> <td rowspan="5">400000</td> <td rowspan="5">16000</td> <td rowspan="5">1</td> </tr> <tr><td>156</td></tr> <tr><td>622</td></tr> <tr><td>2488</td></tr> <tr><td>9953</td></tr> </tbody> </table> Accuracy: $\pm Q\%$ of setting ± 100 Ulp-p <table border="1" data-bbox="606 1486 949 1581"> <thead> <tr> <th>Variable Error Q</th> <th>Frequency Range</th> </tr> </thead> <tbody> <tr> <td>$\pm 8\%$</td> <td>10 μHz to 0.125 Hz</td> </tr> <tr> <td>$\pm 12\%$</td> <td>0.125 Hz to 1 Hz</td> </tr> <tr> <td>$\pm 15\%$</td> <td>1 Hz to 10 Hz</td> </tr> </tbody> </table>	Frequency (Hz)	F0 (Hz)	F1 (Hz)	F2 (Hz)	A0 (Ulp-p)	A1 (Ulp-p)	Step (Ulp-p)	52	10 μ	400 m	10	400000	16000	1	156	622	2488	9953	Variable Error Q	Frequency Range	$\pm 8\%$	10 μ Hz to 0.125 Hz	$\pm 12\%$	0.125 Hz to 1 Hz	$\pm 15\%$	1 Hz to 10 Hz	
Frequency (Hz)	F0 (Hz)	F1 (Hz)	F2 (Hz)	A0 (Ulp-p)	A1 (Ulp-p)	Step (Ulp-p)																						
52	10 μ	400 m	10	400000	16000	1																						
156																												
622																												
2488																												
9953																												
Variable Error Q	Frequency Range																											
$\pm 8\%$	10 μ Hz to 0.125 Hz																											
$\pm 12\%$	0.125 Hz to 1 Hz																											
$\pm 15\%$	1 Hz to 10 Hz																											
Wander Measurement (MU150125A-01)	Bit Rate (bit/s): 52M, 156M, 622M, 2488M, 9953M Evaluation Mode: TIE (P-P, +P, -P) Range p-p: 0.0 to 2E10 ns +p, -p: 0.0 to 1E10 ns	Resolution: 0.1 ns Accuracy: TIE $\pm 0.5\% \pm Z0$ (t) Filter Selection: DC to 10 Hz, DC to 0.01 Hz, 0.01 Hz to 10 Hz <table border="1" data-bbox="973 1696 1364 1770"> <thead> <tr> <th>Z0 (t) (ns)</th> <th>Observation Time t (s)</th> </tr> </thead> <tbody> <tr> <td>2.5 + 0.0275 t</td> <td>0.05 \leq t \leq 1000</td> </tr> <tr> <td>29 + 0.001 t</td> <td>t > 1000</td> </tr> </tbody> </table>	Z0 (t) (ns)	Observation Time t (s)	2.5 + 0.0275 t	0.05 \leq t \leq 1000	29 + 0.001 t	t > 1000																				
Z0 (t) (ns)	Observation Time t (s)																											
2.5 + 0.0275 t	0.05 \leq t \leq 1000																											
29 + 0.001 t	t > 1000																											



Ordering Information

Please specify the model/order number, name and quantity when ordering.
The names listed in the chart below are Order Names. The actual name of the item may differ from the Order Name.

Model/Order No.	Name
Main Frame	
MP1590B	Network Performance Tester
Standard Accessories	
J0491	Shield Power Cord, 2.6 m*1: 1 pc
F0105	Fuse, 10 A*1: 2 pcs
E0010	Side Cover*1: 1 pc
B0329G	Front Cover (for 3/4MW4U)*1: 1 pc
Z0847A	MD1230/MP1590 Family Software CD*1, *2: 1 pc
J0617B	Replaceable Optical Connector (FC-PC)*3, *4: 1 pc/2 pcs
J0747B	Fixed Optical Attenuator (10 dB, FC connector)*5: 1 pc
J0747C	Fixed Optical Attenuator (15 dB, FC connector)*6: 1 pc
J1003N	Semi-rigid Cable (136.6 mm)*7: 2 pcs
J1003P	Semi-rigid Cable (96 mm)*7: 1 pc
J1003Q	Semi-rigid Cable (75.6 mm) *8, *9: 1 pc/2 pcs
J1003R	Semi-rigid Cable (55.3 mm)*7: 1 pc
J1003S	Semi-rigid Cable (56.5 mm)*10: 1 pc
J1003T	Semi-rigid Cable (67 mm)*11: 2 pcs
J0500A	Semi-rigid Cable 50 cm*11: 1 pc
J0994	Terminator (50 Ω) *11, *12: 1 pc
Plug-in Units	
MU150110A	Multirate Unit*13, *14
MU150101A	2.5/2.6G Eos Unit*15
MU150121A	10/10.7G Optical Unit (Tx)*15
MU150121B	10/10.7G Optical/Electrical Unit (Tx)*15
MU150123A	10/10.7G Optical Unit (Rx Wide)
MU150123B	10/10.7G Optical/Electrical Unit (Rx Wide)
MU150124B	10.3G Optical/Electrical Unit (Rx Wide)
MU150125A	10/10.7G Jitter Unit
MU120111A	10/100M Ethernet Module*16
MU120112A	Gigabit Ethernet Module*16, *17
MU120118B	10 Gigabit Ethernet Module*16, *18
MU120118C	10 Gigabit Ethernet Module*16, *18
MU120121A	10/100/1000M Ethernet Module*16
MU120122A	Gigabit Ethernet Module*16, *19
MU120131A	10/100/1000M Ethernet Module*16
MU120132A	Gigabit Ethernet Module*16, *19
MU120138A	10 Gigabit Ethernet Module*16, *20
Options	
MP1590B-01	RS-232C
MP1590B-02	GPIO
MP1590B-03	LAN
MP1590B-07	OSPF Protocol
MP1590B-08	MPLS (LDP/CR-LDP) Protocol
MP1590B-09	MPLS (RSVP) Protocol
MP1590B-10	RFC2899 Benchmarking Test
MP1590B-11	Packet BER Test
MP1590B-12	IPv6 Expansion
MP1590B-13	XENPAK Test
MP1590B-14	IGAP Protocol
MP1590B-15	Auto Negotiation Analysis
MP1590B-16	Link Fault Signalling*21
MP1590B-17	Traffic Impairment Emulator*22
MP1590B-20	Application Traffic Monitor
MP1590B-28	Ethernet OAM
MP1590B-30	High Precision Jitter Analysis*23
MU150110A-004	Optical Output Power Adjustable*24
MU150110A-005	OTU1/OTU2
MU150110A-006	11.1G
MU150110A-008	10.3G
MU150110A-009	Insert/Extract
MU150110A-010	Multichannel Measurement
MU150110A-038	ST Connector*25
MU150110A-039	DIN Connector*25
MU150110A-040	SC Connector*25
MU150110A-043	HMS-10/A Connector*25
MU150101A-01	Wavelength 1.31 μm
MU150101A-02	Wavelength 1.55 μm
MU150101A-03	Wavelength 1.31/1.55 μm
MU150101A-04	Optical Output Power Adjustable

Model/Order No.	Name
MU150101A-05	OTU1
MU150101A-06	GFP-F/LEX/LAPS
MU150101A-07	POS
MU150101A-11	HO Virtual Concatenation
MU150101A-12	LO Virtual Concatenation
MU150101A-13	LCAS
MU150101A-14	Differential Delay*26
MU150101A-38	ST Connector*25
MU150101A-39	DIN Connector*25
MU150101A-40	SC Connector*25
MU150101A-43	HMS-10/A Connector*25
MU150121A-01	Wavelength 1.31 μm
MU150121A-02	Wavelength 1.55 μm
MU150121A-03	Wavelength 1.31 /1.55 μm
MU150121A-04	Optical Output Power Adjustable
MU150121A-38	ST Connector*25
MU150121A-39	DIN Connector*25
MU150121A-40	SC Connector*25
MU150121A-43	HMS-10/A Connector*25
MU150121B-01	Wavelength 1.31 μm
MU150121B-02	Wavelength 1.55 μm
MU150121B-03	Wavelength 1.31 /1.55 μm
MU150121B-04	Optical Output Power Adjustable
MU150121B-38	ST Connector*25
MU150121B-39	DIN Connector*25
MU150121B-40	SC Connector*25
MU150121B-43	HMS-10/A Connector*25
MU150123A-05	OTU2
MU150123A-38	ST Connector*25
MU150123A-39	DIN Connector*25
MU150123A-40	SC Connector*25
MU150123A-43	HMS-10/A Connector*25
MU150123B-05	OTU2
MU150123B-38	ST Connector*25
MU150123B-39	DIN Connector*25
MU150123B-40	SC Connector*25
MU150123B-43	HMS-10/A Connector*25
MU150124B-38	ST Connector*25
MU150124B-39	DIN Connector*25
MU150124B-40	SC Connector*25
MU150124B-43	HMS-10/A Connector*25
MU150125A-01	Wander Measurement
MU150125A-05	OTU1/OTU2
MU150125A-06	10.3G
MU120131A-01	Clock Measurement
MU120131A-02	PoE
MU120131A-12	PoE Retrofit
MU120132A-01	Clock Measurement
MU120138A-01	Clock Measurement
MU120138A-03	Link Fault Signalling*21
Software	
MX159001B	Network Performance Tester Control Software*27
MX159001B-05	Network Performance Tester Control Software (5 licenses)
MX159001B-08	Network Performance Tester Control Software (8 licenses)
Software Options	
MX159001B-01	RS-232C Control
MX159001B-02	GPIO Control
MX159001B-03	Ethernet Control
Optional Accessories	
G0105A	GBIC SX 850 nm*28
G0106A	GBIC LX 1310 nm*28
G0107A	GBIC LH 1310 nm*28
G0108A	GBIC ZX 1550 nm*28
G0124A	GBIC T (1000 BASE-T)*28
G0181A	SFP SX 850 nm*29
G0182A	SFP LX 1310 nm*29
G0183A	SFP LE 1310 nm*29
G0184A	SFP LR 1550 nm*29
G0277A	XENPAK (10 GBASE-SR)*30

Model/Order No.	Name
G0192A	XENPAK (10 GBASE-LR)*30
G0193A	XENPAK (10 GBASE-ER)*30
G0238A	SFP+ SR 850 nm*31
G0239A	SFP+ LR 1310 nm*31
G0271A	SFP+ ER 1550 nm*31
G0194A	1310 nm XFP Module*32
G0195A	1550 nm XFP Module*32
J0796A	ST Connector (replaceable, with protective caps, 1 set)
J0796B	DIN Connector (replaceable, with protective caps, 1 set)
J0796C	SC Connector (replaceable, with protective caps, 1 set)
J0796D	HMS-10/A Connector (replaceable, with protective caps, 1 set)
J0796E	FC Connector (replaceable, with protective caps, 1 set)
J0617B	Replaceable Optical Connector (FC-PC)
J0747B	Fixed Optical Attenuator (10 dB, FC Connector)
J0747C	Fixed Optical Attenuator (15 dB, FC Connector)
J0747D	Fixed Optical Attenuator (20 dB, FC Connector)
J1049A	Fixed Optical Attenuator (SC, 5 dB)
J1049B	Fixed Optical Attenuator (SC, 10 dB)
J1049C	Fixed Optical Attenuator (SC, 15 dB)
J1376A	Fixed Optical Attenuator (5 dB, LC connector)
MZ1221A	XAUI Extender*33
MZ1222A	XENPAK Interface*34
J1163A	XAUI Cable, 0.5 m
J1164A	MDIO Cable, 0.5 m
J0635A	Optical Fiber Cable (SM, FC-SPC connector both ends), 1 m
J0635B	Optical Fiber Cable (SM, FC-SPC connector both ends), 2 m
J0635C	Optical Fiber Cable (SM, FC-SPC connector both ends), 3 m
J0660B	Optical Fiber Cord (SM, SC-SC connector), 2 m
J0773B	Optical Fiber Cord (GI, SC-SC connector), 2 m
J1344A	Optical Fiber Cord (Simplex, SM, LC-LC connector), 1 m
J1327B	Optical Fiber Cord (Simplex, SM, LC-LC connector), 2 m
J1119B	Optical Fiber Cord (Duplex, MM), 2 m
J1271	Optical Fiber Cord (Duplex, SM, LC-LC connector), 2 m
J1272	Optical Fiber Cord (Duplex, SM, LC-SC connector), 2 m
J1273	Optical Fiber Cord (Duplex, GI, LC-LC connector), 2 m
J1274	Optical Fiber Cord (Duplex, GI, LC-SC connector), 2 m
J1139A	Optical Fiber Cord (Simplex, SM, LC-FC connector), 1 m
J1003N	Semi-rigid Cable (136.6 mm)
J1003P	Semi-rigid Cable (96 mm)
J1003Q	Semi-rigid Cable (75.6 mm)
J1003R	Semi-rigid Cable (55.3 mm)
J1003S	Semi-rigid Cable (56.5 mm)
J0776D	Coaxial Cable (BNC-P-3W · 3D-2W · BNC-P-3W, 50 Ω), 2 m
J0322B	Coaxial Cable (11SMA · SUCOFLEX104 · 11SMA), 1 m
J0696A	Coaxial Cable (AA-165-500), 0.5 m
J1268	Semiflexible Coaxial Cable
J1349A	Coaxial Cable, 0.3 m
J1173	6020180 Power Divider
J1059B	Balanced Cable (RJ-45/Siemens 3P), 2 m
J1060B	Balanced Cable (RJ-45/BANTAM 3P), 2 m
J0008	GPIB Cable, 2 m
J1109B	LAN Cable (CAT5, cross), 5 m
J1110B	LAN Cable (CAT5, straight), 5 m
J1275	LAN Cable (CAT5E, straight), 1 m
J1275B	LAN Cable (CAT5E, straight), 5 m
J1275C	LAN Cable (CAT5E, cross), 1 m
J1275D	LAN Cable (CAT5E, cross), 5 m
Z0989A	1310 nm XFP Kit*35
Z0990A	1550 nm XFP Kit*36
Z0321A	Keyboard (PS/2)
Z0541A	USB Mouse
Z0282	Ferrule Cleaner
Z0283	Ferrule Cleaner Replacement Tape
Z0284	Adapter Cleaner
Z0838A	Stick Cleaner 1.25 mm (250 pcs/set)
B0336C	Carrying Case (3/4MW4U, 350D)
B0530	Carrying Case caster for B0336C
B0448	Soft Case
B0593A	Blank Panel
B0588A	Rack Mount Kit*37

Model/Order No.	Name
Z0849A	MD1230/MP1590 Family Manual CD
W2420AE	MP1590B Operation Manual
W2421AE	MX159001B Operation SDH Edition Manual
W2422AE	MX159001B Operation SONET Edition Manual
W2423AE	MP1590B/MP1591A Remote Control Operation Manual
W2134AE	Application Traffic Monitor Operation Manual
W1931AE	Ethernet Module Operation Manual
W3218AE	MU150110A Specifications Operation Manual
W2425AE	MU150101A Specifications Operation Manual
W2426AE	MU150125A Specifications Operation Manual
W2427AE	MU150121/2/3/34A Specifications Operation Manual
W2589AE	MU150121B/123B Specifications Operation Manual
W2590AE	MU150124B Specifications Operation Manual

- *1: Supplied with main frame.
- *2: CD includes installer, release notes and operation manual.
- *3: Supplied with MU150110A, MU150101A, MU150121A/B, MU150123A/B, and MU150124B.
- *4: Two pieces of MU150110A, and MU150101A.
- *5: Supplied with MU150123A/B, and MU150124A.
- *6: Supplied with MU150101A.
- *7: Supplied with MU150125A.
- *8: Supplied with MU150121A/B, MU150123A/B, and MU150124B.
- *9: One piece of MU150123A/B, and MU150124B, and two pieces of MU150121A/B.
- *10: Supplied with MU150110A, and MU150101A.
- *11: Supplied with MU150121B.
- *12: Supplied with MU150110A.
- *13: Requires XFP module (sold separately). In addition, operation with non-Anritsu modules not guaranteed.
- *14: An XFP module (G0194A/G0195A) and fixed optical attenuator (J0747C, J1376A) are required when performing the self-test.
- *15: One of Option-01, 02, 03 required.
- *16: Order additional J1349A when Ethernet unit is installed simultaneously in SDH/SONET/OTN/PDH/DSn unit and jitter unit configurations.
- *17: Requires GBIC module (sold separately). In addition, operation with non-Anritsu modules not guaranteed.
- *18: Requires XENPAK module (sold separately). In addition, operation with non-Anritsu modules not guaranteed.
- *19: Requires SFP module (sold separately). In addition, operation with non-Anritsu modules not guaranteed.
- *20: Requires SFP+ module (sold separately). In addition, operation with non-Anritsu modules not guaranteed.
- *21: The MP1590B-16 is supported by the MU120118B/C. The MU120138A-03 is supported by the MU120138A.
- *22: Only ports 1 and 2 of the the MU120121A/122A support the MP1590B-17 Traffic Impairment Emulator option. Moreover, only MU120121A/122A models shipped after March 7, 2008 with the "Supports Opt.17" sticker support the option.
- *23: MP1590B-30 option can be added to the main frame before delivery. But it cannot be added after.
- *24: Only enabled for optical output signals up to 2.6G.
- *25: Exchangeable.
- *26: Requires one of MU150101A-11 or MU150101A-12.
- *27: MP1590B-03 not required. However, the maximum number of MP1590B units that can be controlled simultaneously with one licence is limited o 8.
- *28: GBIC modules sold as single units. Two can be mounted in MU120112A.
- *29: SFP modules sold as single units. Two can be mounted in MU120122A and eight in MU120132A.
- *30: XENPAK modules sold as single units. Two can be mounted in MU120118B and one in MU120118C. G0277A, G0192A and G0193A only supported by MU120118A/B/C units with "With APS" sticker. DO NOT install in MU120118A/B/C units without "With APS" sticker. G0277A, G0192A and G0193A have "Only for APS" stickers attached.
- *31: SFP+ modules sold as single units. Four can be mounted in MU120138A.
- *32: XFP modules sold as single units. One can be mounted in MU150110A.
- *33: When using XAUI extender, MZ1222A XENPAK interface, J1163A XAUI cable, and J1164A MDIO cable required along with separate external power supply (5 V, 4 A)
- *34: MZ1222A supplied by 1.8-V APS.
- *35: G0194A and J1344A included in Z0989A.
- *36: G0195A, J1344A, and J1376A included in Z0990A.
- *37: Rack mount Kit for MP1590B.



B0336C Carrying Case



B0448 Soft Case

• Other

Software Upgrade Service

Model/Order No.	Name
	Software Upgrade Service
MP1590B-40	Annual Software Upgrade Service

*: Option for latest versions of main frame, plug-in units and software. Purchased annually; no multi-year contracts. Can also be purchased at any time after main-frame purchase.

Maintenance Service

Model/Order No.	Name
	Maintenance Service
***-ES210	2 Years Extended Warranty Service
***-ES310	3 Years Extended Warranty Service
***-ES510	5 Years Extended Warranty Service

*: Extends standard 1-year warranty service period on new main frame and plug-in units to 2, 3, or 5 years. Purchased separately at new purchase. (Cannot be purchased mid-contract, at contract renewal or in multi-year combinations.)

***-ES210: MP1590B-ES210, MU150110A-ES210, MU150101A-ES210, MU150121A-ES210, MU150121B-ES210, MU150123A-ES210, MU150123B-ES210, MU150124B-ES210, MU150125A-ES210, MU120111A-ES210, MU120112A-ES210, MU120118B-ES210, MU120118C-ES210, MU120121A-ES210, MU120122A-ES210, MU120131A-ES210, MU120132A-ES210, MU120138A-ES210

***-ES310: MP1590B-ES310, MU150110A-ES310, MU150101A-ES310, MU150121A-ES310, MU150121B-ES310, MU150123A-ES310, MU150123B-ES310, MU150124B-ES310, MU150125A-ES310, MU120111A-ES310, MU120112A-ES310, MU120118B-ES310, MU120118C-ES310, MU120121A-ES310, MU120122A-ES310, MU120131A-ES310, MU120132A-ES310, MU120138A-ES310

***-ES510: MP1590B-ES510, MU150110A-ES510, MU150101A-ES510, MU150121A-ES510, MU150121B-ES510, MU150123A-ES510, MU150123B-ES510, MU150124B-ES510, MU150125A-ES510, MU120111A-ES510, MU120112A-ES510, MU120118B-ES510, MU120118C-ES510, MU120121A-ES510, MU120122A-ES510, MU120131A-ES510, MU120132A-ES510, MU120138A-ES510



Specifications are subject to change without notice.

• **United States**

Anritsu Company
1155 East Collins Blvd., Suite 100, Richardson, TX 75081, U.S.A.
Toll Free: 1-800-267-4878
Phone: +1-972-644-1777
Fax: +1-972-671-1877

• **Canada**

Anritsu Electronics Ltd.
700 Silver Seven Road, Suite 120, Kanata, Ontario K2V 1C3, Canada
Phone: +1-613-591-2003
Fax: +1-613-591-1006

• **Brazil**

Anritsu Eletrônica Ltda.
Praça Amadeu Amaral, 27 - 1 Andar
01327-010 - Bela Vista - São Paulo - SP - Brazil
Phone: +55-11-3283-2511
Fax: +55-11-3288-6940

• **Mexico**

Anritsu Company, S.A. de C.V.
Av. Ejército Nacional No. 579 Piso 9, Col. Granada
11520 México, D.F., México
Phone: +52-55-1101-2370
Fax: +52-55-5254-3147

• **United Kingdom**

Anritsu EMEA Ltd.
200 Capability Green, Luton, Bedfordshire, LU1 3LU, U.K.
Phone: +44-1582-433200
Fax: +44-1582-731303

• **France**

Anritsu S.A.
12 avenue du Québec, Bâtiment Iris 1- Silic 612,
91140 VILLEBON SUR YVETTE, France
Phone: +33-1-60-92-15-50
Fax: +33-1-64-46-10-65

• **Germany**

Anritsu GmbH
Nemetschek Haus, Konrad-Zuse-Platz 1
81829 München, Germany
Phone: +49-89-442308-0
Fax: +49-89-442308-55

• **Italy**

Anritsu S.r.l.
Via Elio Vittorini 129, 00144 Roma, Italy
Phone: +39-6-509-9711
Fax: +39-6-502-2425

• **Sweden**

Anritsu AB
Borgarfjordsgatan 13A, 164 40 KISTA, Sweden
Phone: +46-8-534-707-00
Fax: +46-8-534-707-30

• **Finland**

Anritsu AB
Teknobulevardi 3-5, FI-01530 VANTAA, Finland
Phone: +358-20-741-8100
Fax: +358-20-741-8111

• **Denmark**

Anritsu A/S (Service Assurance)
Anritsu AB (Test & Measurement)
Kay Fiskers Plads 9, 2300 Copenhagen S, Denmark
Phone: +45-7211-2200
Fax: +45-7211-2210

• **Russia**

Anritsu EMEA Ltd.
Representation Office in Russia
Tverskaya str. 16/2, bld. 1, 7th floor.
Russia, 125009, Moscow
Phone: +7-495-363-1694
Fax: +7-495-935-8962

• **United Arab Emirates**

Anritsu EMEA Ltd.
Dubai Liaison Office
P O Box 500413 - Dubai Internet City
Al Thuraya Building, Tower 1, Suit 701, 7th Floor
Dubai, United Arab Emirates
Phone: +971-4-3670352
Fax: +971-4-3688460

• **Singapore**

Anritsu Pte. Ltd.
60 Alexandra Terrace, #02-08, The Comtech (Lobby A)
Singapore 118502
Phone: +65-6282-2400
Fax: +65-6282-2533

• **India**

Anritsu Pte. Ltd.
India Branch Office
3rd Floor, Shri Lakshminarayan Niwas, #2726, 80 ft Road,
HAL 3rd Stage, Bangalore - 560 075, India
Phone: +91-80-4058-1300
Fax: +91-80-4058-1301

• **P.R. China (Shanghai)**

Anritsu (China) Co., Ltd.
Room 1715, Tower A CITY CENTER of Shanghai,
No.100 Zunyi Road, Chang Ning District,
Shanghai 200051, P.R. China
Phone: +86-21-6237-0898
Fax: +86-21-6237-0899

• **P.R. China (Hong Kong)**

Anritsu Company Ltd.
Units 4 & 5, 28th Floor, Greenfield Tower, Concordia Plaza,
No. 1 Science Museum Road, Tsim Sha Tsui East,
Kowloon, Hong Kong, P.R. China
Phone: +852-2301-4980
Fax: +852-2301-3545

• **Japan**

Anritsu Corporation
8-5, Tamura-cho, Atsugi-shi, Kanagawa, 243-0016 Japan
Phone: +81-46-296-1221
Fax: +81-46-296-1238

• **Korea**

Anritsu Corporation, Ltd.
502, 5FL H-Square N B/D, 681
Sampyeong-dong, Bundang-gu, Seongnam-si,
Gyeonggi-do, 463-400 Korea
Phone: +82-31-696-7750
Fax: +82-31-696-7751

• **Australia**

Anritsu Pty. Ltd.
Unit 21/270 Ferntree Gully Road, Notting Hill,
Victoria 3168, Australia
Phone: +61-3-9558-8177
Fax: +61-3-9558-8255

• **Taiwan**

Anritsu Company Inc.
7F, No. 316, Sec. 1, NeiHu Rd., Taipei 114, Taiwan
Phone: +886-2-8751-1816
Fax: +886-2-8751-1817