

ADVANTEST

R3765CG/3767CG
Network Analyzer

From Evaluation and Analysis to Inspection of High-Frequency Multi-Port and Balanced Devices



R3765CG/3767CG

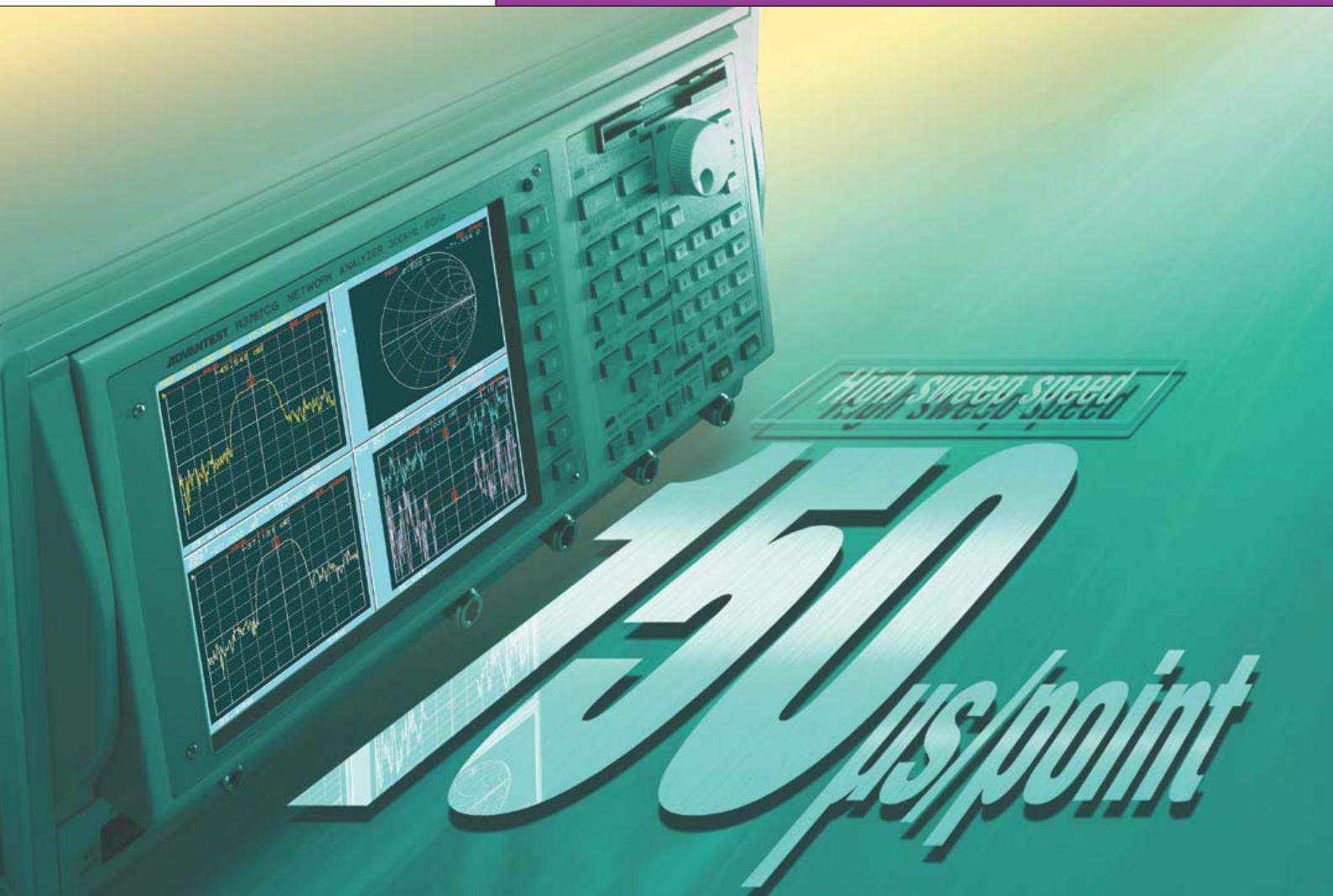

Vector Network Analyzers in the R3765CG/3767CG propose a new RF circuit analysis procedure. Range of measurement frequency is 300 kHz to 3.8 GHz (R3765CG) or 300 kHz to 8 GHz (R3767CG). A unique high-speed signal processing technology adopted to the R3765CG/3767CG has realized enhanced measuring speed. The R3765CG/3767CG are a model with a built-in S parameter test set to deal with forward/reverse directions measurements. Further, lined up, as optional, are a model with a built-in 3-port test set and a model with a built-in 4-port test set. Additional installation of input channels to the receptor assembly of these multi-port models will make them capable of performing simultaneous measurement of 2 different paths to be tested. Adopting this method will result in substantial improvement to measuring efficiency of multi-port devices. Adopted is 8.4-inch TFT color LC monitor that is capable of displaying 4-sectioned screens at a time, thus making possible of choosing independently one measuring path in each section, realizing simultaneous display of a maximum of 4 paths and 8 parameters that results in an instantaneous analysis of variety of items subject to measurements. Sweep time is as short as 150 μ s/point, thus realizing a further high speed.

An optional software fixture makes ease of measurement of standardized impedance other than 50 Ω system. This function performs impedance conversion by use of software, reducing the need to prepare hardware such as an impedance converter, which previously was required. Measurements of balanced circuits and matching networks such as filters, amplifiers, etc. can be simulated by means of the network analyzer, thus making it possible to deal with variety of applications.

An existing well-reputed built-in BASIC controller option is also incorporated as a standard function, thus offering expansibility to deal with variety of automated measurement applications.





High-speed, High-accuracy Measurements

- 150 μs /point (with 2-port Full Calibration)
- 3-port or 4-port full calibration
- High-speed data transfer rate
- Extended resolutions (10 Hz to 20 kHz) set by IF RBW

Wide View Multi Screen

- Uses 8.4-inch TFT color LC monitor
- Enhanced visibility to waveforms
- Varieties of displaying layouts

Extended Analysis Functions

- New system, built-in 3-port test set
- 4-channel independent paths displaying function
- CDMA IF filter analysis
- Time domain analysis

Superior Operability

- Verification
- Limit-line function
- Automatic calibration

PC Friendly

- Built-in BASIC Controller
- Built-in programming editor
- Varieties of interfaces for external devices

Software Fixture

- Impedance conversion function
- Matching networking function
- Port conversion function
- Balance parameter measurement function
- Data storage function

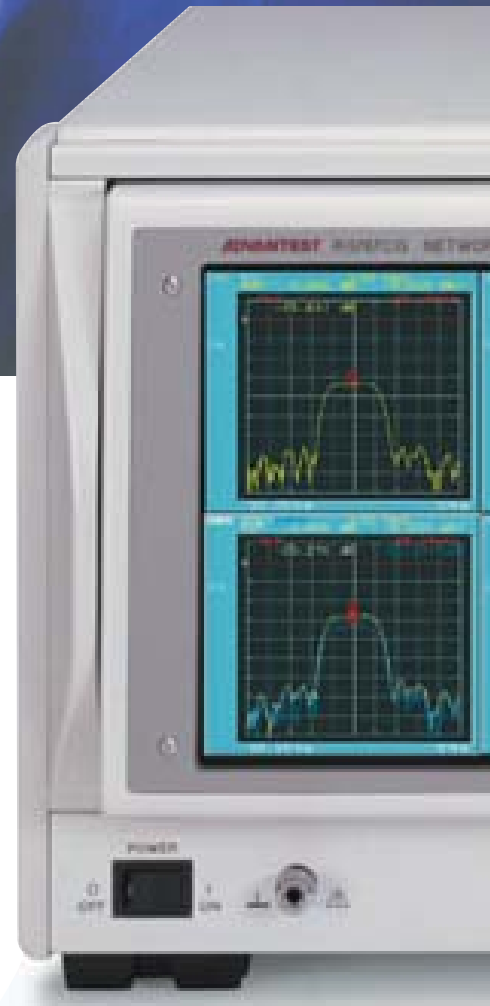

High-speed, High-accuracy Measurements

R3765CG: 300 kHz to 3.8 GHz
R3767CG: 300 kHz to 8.0 GHz

OPT.11: Model with a built-in 3-port test set

OPT.14: Model with a built-in 4-port test set

Superior Basic Performance

- Sweep Time: 150 μ s/point (with 2-port full calibration)
- RBW: 10 Hz to 20 kHz (Variable steps – 1, 1.5, 2, 3, 4, 5, 7)
- Tracing Noise: 0.003 dB (typical)

Wide View Multi Screen

- 8.4-inch TFT color LC monitor
- Enhanced visibility to waveforms
- Varieties of displaying layouts

Balanced Device Analysis Function (optional)

- Balanced devices measurements: Software Fixture
- Multi-port Measurement:
 - Built-in type (3 or 4 port)
 - Test Adapter type (5 or 6 port)

- Built-in BASIC Controller Function – provided as a standard function
- Built-in Programming Editor
- VGA Output
- Printer Interface – provided as a standard function



Wide View Multi Screen.....Variety of layouts for displaying waveforms

For all applications such as designing RF circuits, test manufacture, or on production lines, instantaneous analysis of variety of items to be measured is the important matter that cannot be missed for shortening time of product development and reducing production costs. For testing multi-port devices,

analysis of S parameter becomes necessary and all items displayed must be identified at instance. The 8.4-inch TFT color LC monitor introduced this time and its various display layouts function is help to enhancing work efficiency.

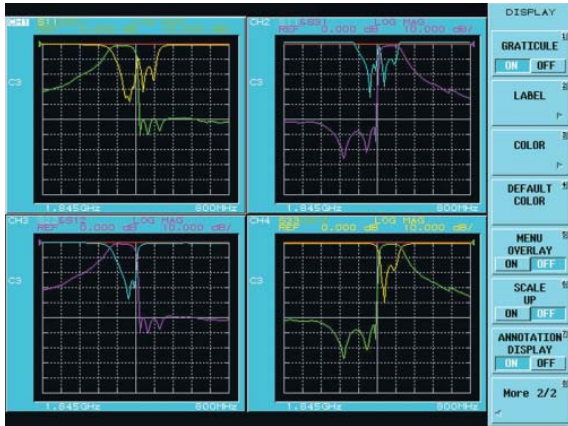

Simultaneous Analysis of transmission/reception of duplexer

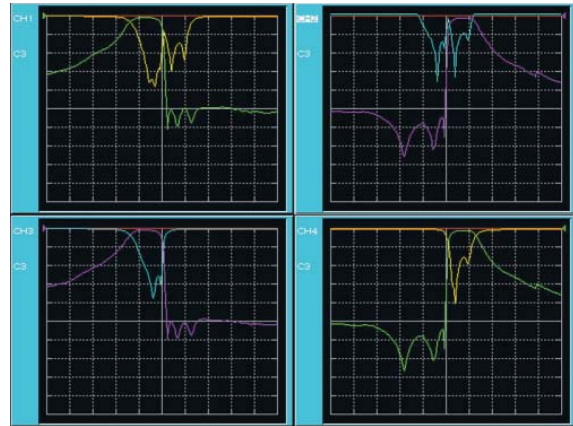

Simultaneous Analysis of transmission/reception in a duplexer with ANNOTATION OFF

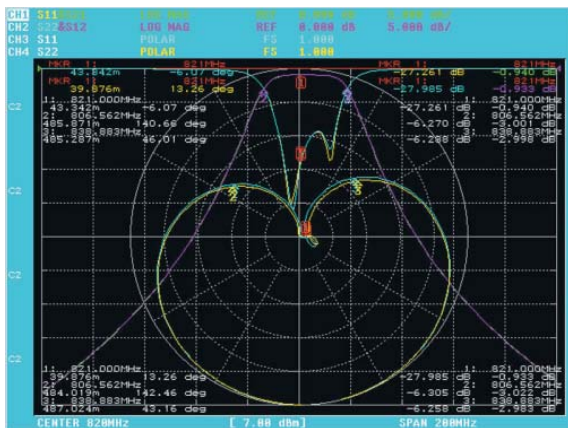

4-channel, 6-trace display with ANNOTATION ON, MENU OVERLAY OFF, SCALE UP OFF

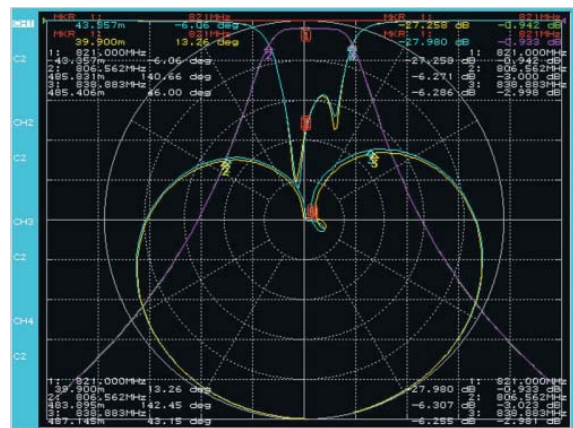

4-channel, 6-trace display with ANNOTATION OFF, MENU OVERLAY OFF, SCALE UP ON



4-channel, 6-trace display with MARKER LIST SPLIT ON

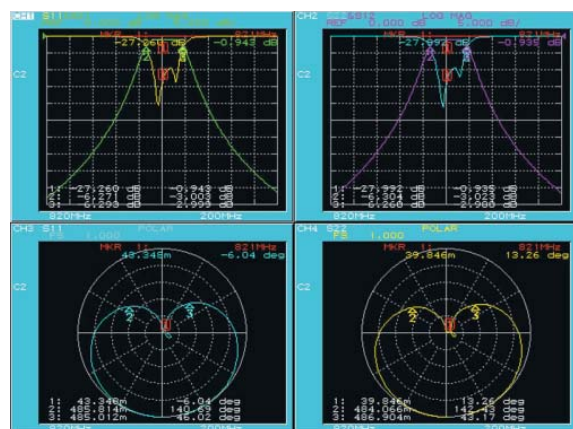

4-channel, 6-trace display with MARKER LIST SPLIT OFF

Extended Analysis Function 3-port measurements

3-port Test Set, a New system

For 3765CG/3767CG provided, as optional, is a built-in 3-port test set. Saving space is not only the advantage of building in this test set. ADVANTEST has always been leading the trade in the field of enhancing testing efficiency of 3-port devices. The new 3-port device testing function has adopted a new system that is capable of reducing measuring time to a maximum of one half as compared with that required by existing system. In the new system, 1 channel was added to the received signal processing assembly, thus making it to have a total of 4-channels. Duplexer, for example, completes acquisition of all parameters by 3 sweeps, while existing system using switches requires 6 sweeps for the same job. Thus, the improved system enables measuring time to be reduced to a maximum of one half.

①ANT Reflection	ANT→Tx Transmission	ANT→Rx Transmission
②Tx Reflection	Tx→ANT Transmission	Tx→Rx Transmission
③Rx Reflection	Rx→ANT Transmission	Rx→Tx Transmission

For Measuring Paths Display Function with 4 Independent Channels

Every channels are independent each other, thus making possible of selecting each measuring path. In a duplexer measurement, following parameters for 3 paths can be displayed at a time.

①ANT→Tx	Transmission/Reflection
②Rx→ANT	Transmission/Reflection
③Tx→Rx	Transmission (isolation)
④ANT	Reflection

4-port Full Calibration

By 4-port device testing, it is not possible to remove thoroughly error factors from a system tested by a 2-port full calibration. For high accuracy testing of 4-port devices, error factors other than those in the paths being tested must be taken into consideration. Models having built-in 4-port test set are also equipped with 4-port full calibration function that solves such a problem. When measuring a 4-port device, full 4-port calibration thoroughly corrects errors from measurement system of 4-port networks. Accordingly, when measurements on the path between port 1 and 2 are performed, measurements on the paths between all ports are performed. In other words, the measurement on all possible six paths between 4 ports (1-2, 1-3, 1-4, 2-3, 2-4, and 3-4) are performed, thus all of sixteen S parameters have been obtained.

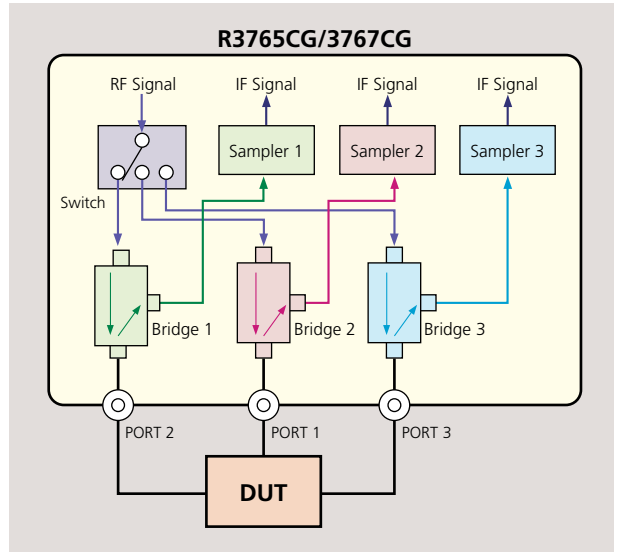

Block Diagram of New built-in 3-port Test Set System

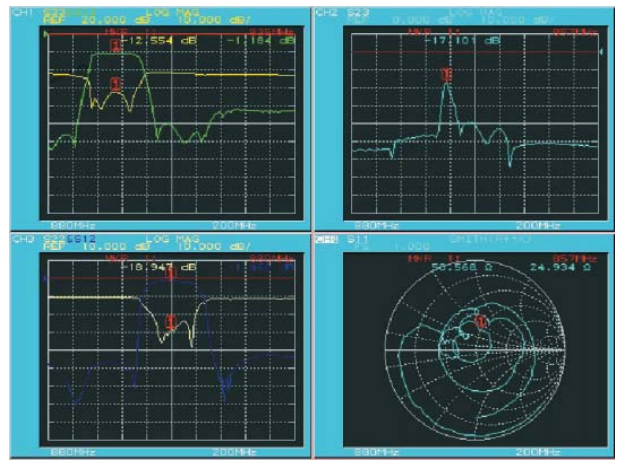

Simultaneous Display of Tx, Rx Isolation characteristics for Duplexer

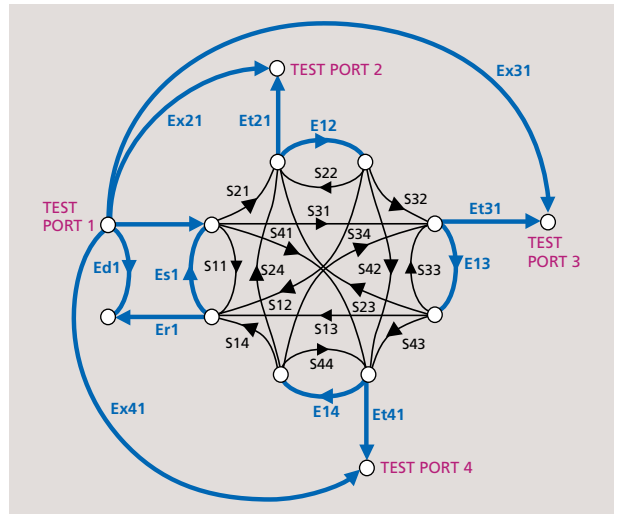

Error Model of 4-port Device

Extended Analysis FunctionCDMA Filter Analysis, TDR Analysis

CDMA IF Filter Analysis Function

An amplitude characteristic analysis function needed for the CDMA IF filter is now actuated through direct key operation. Thus, GATE function is now able to perform measurements being not bothered by affects of multi-reflection. This GATE function performs high-speed analysis because it is processed on the frequency domain.

- CF: Center frequency between 2 points of X dB down from the peak.
- BW: Frequency bandwidth between 2 points of X dB down from the peak.
- IL: Peak level value.
- RPL: Difference between the lowest value and the peak within a pass band.
- ATTN1: Level difference between the peak and lower value among 2 points by the specified frequency #1 apart from the peak.
- ATTN2: Level difference between the peak and lower value among 2 points by the specified frequency #2 apart from the peak.
- PL: Phase linearity.

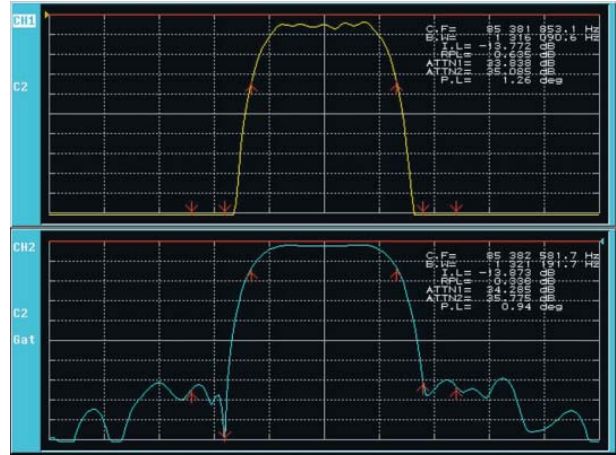

Comparative Measurements between GATE ON and GATE OFF at CDMA IF Filter Analysis

Time Domain Analysis Function

Using time domain analysis function makes possible to analyze the affection of multiple reflection on time axis domain. Using the time domain analysis function in couple with GATE function makes possible of simultaneous analysis of affects of a multiple reflection signal to the phase linearity and the like.

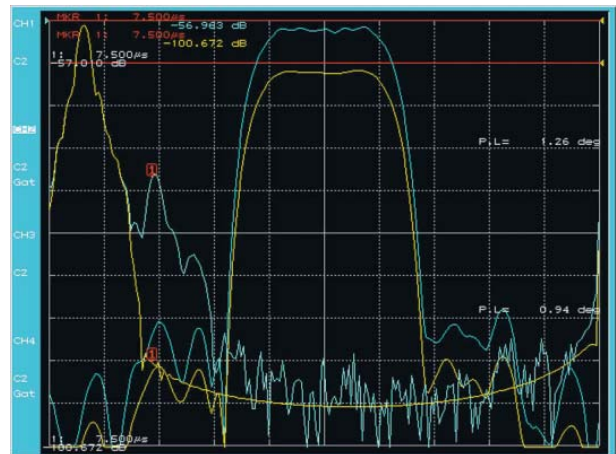

Comparison of GATE ON and GATE OFF at Frequency Axis and Time Axis

Joint Use of Time Domain Analysis and GATE Function

Using jointly the time domain analysis and GATE function makes possible of simultaneous analysis of affects of multiple reflections at both frequency domain and time domain. Each individual waveform divided into 4-channels are updated in real time.

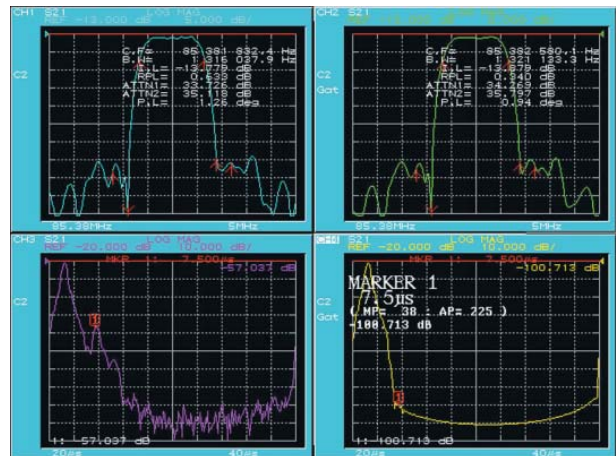

Joint Use of CDMA IF Filter analysis and Time Domain Analysis

Superior Operability

Verification

Verification function is automatically executed on completion of automatic calibration. It verifies quickly whether correction of errors was done a target area by the calibration function. It generates error-warning announcement if any of such corrections exceeded a limit. Ranges of such the limit are of user defined, so users can select a verification criterion meeting the purpose of testing.

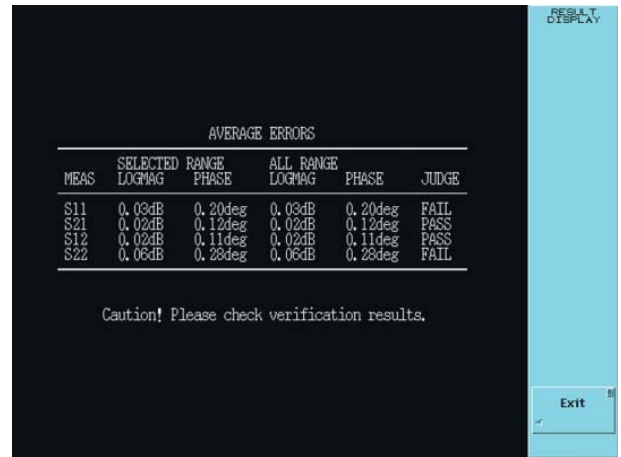

Limit Line Function

This function determines PASS or FAIL of items tested, by making reference to a standard value set by means of limit line editor. Results of judgment are reported by means of PASS/FAIL displays and buzzer (selectable for PASS or FAIL). In addition, such the results of judgment can be transmitted to an external device. On polar and smith chart, standard value setting on phase axis is possible. Limit lines can be set for each individual trace.

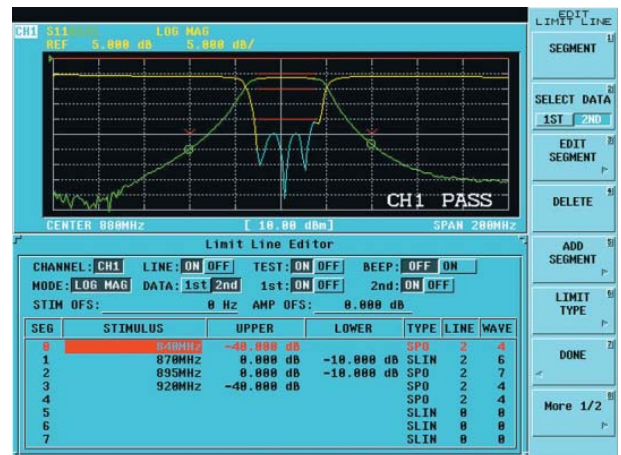

Automatic Calibration Kit (optional)

Calibrations cannot be omitted for high accuracy measurements. Existing calibration procedures, however, contain many error factors. Performing accurate measurements by avoiding such error factors require experienced operators. 2-port full calibration, for example, requires connections of calibration standards for a minimum of 7 times. Implementing such connection requires precise connecting condition. Otherwise, results will be obtaining those judgments containing error factors.

By using an Automatic Calibration Kit “anyone” can simply achieve “high accuracy measurements”. Even for 2-port calibration, number of times for connections is reduced to 2 times but it results in substantially enhanced measurement efficiency. The kit can be simply connected to the rear panel of a network analyzer with uncompromised work environment.

R17050 Automatic Calibration Kit

- Range of frequency: 40 MHz to 8 GHz (differs than the range of frequency for the network analyzer)
- Range of operating temperature: 20 to 30°C
- Measurement accuracy: ±0.05 dB (typical)
- Temperature coefficient: 0.002 dB/°C (typical)
- Connector: 3.5 mm



R17050 Automatic Calibration Kit

PC Friendly

Built-in BASIC Controller

Since this network analyzer has a built-in computer, a high-speed ATE system can be constructed with great facility and the entire cost can be reduced by automating measurements, adjustments, and inspection processes without an external controller.



Program Editor

BASIC programs, required for installation of a network analyzer on an automatic adjuster or automatic inspection system, can be programmed on a text editor of a personal computer. Floppy diskettes (720 K, 1.44 Mbytes) are those conform to MS-DOS. A network analyzer has a program editor on board, so programs can be directly entered and/or edited by operation of a keyboard (IBM PC-AT compatible) on the market, thus helping reduction of man-hour for development of programs.

A screenshot of the network analyzer's BASIC program editor interface. The window title is "File Edit View Search Run". The main area shows BASIC code for a program named "TEST_02.BAS". A menu is open over the "Run" button, showing options: Start, Initialize, Continue, Upload, and Download. The code includes sections for setup, calibration, and measurement.

```
* main File: TEST_02.BAS
1130 GOSUB *MEAS
1140 GOSUB *RESULTS
1150 GOTO *MEAS_LOOP
1160
1170 *SETUP
1180 INTEGER EV
1190 NP=SI :EV=1
1200 OUTPUT NA;"OLDG OFF"
1210 OUTPUT NA;"SYST:PRES;:INIT:CONT OFF;:STAT:OPER:ENAB 8;:SRE 128;:OPC?"
1220 ENTER NA;A
1230 OUTPUT NA;"FREQ:SPAN 200MAHZ;CENT 880MAHZ"
1240 OUTPUT NA;"CALC:TRAN:IMP:CIMP 12.5;TYPE ZTR"
1250 RETURN
1260
1270 *CAL
1280 CURSOR 6,9 :PRINT "CONNECT [THROUGH]"
1290 CURSOR 6,10:INPUT "IF OK THEN PRESS 'ENT' or 'X1'",D$
1300 OUTPUT NA;"CORR:COLL NORM;:OPC?":ENTER NA;A
1310
1320 *MEAS
1330 CURSOR 6,26:PRINT "CONNECT DUT"
1340 CURSOR 6,26:INPUT "IF OK THEN PRESS 'ENT' or 'X1'",D$
1350 OUTPUT NA;"INIT":WAIT EVENT EV
1360 FR1=FMAX(0,1200,0):AP1=POINT1(FR1,0)
1370 FR2=FMIN(0,1200,0):AP2=POINT1(FR2,0)
1380 FS1=ZEROPHS(AP1-60,AP1+60,8):LV1=VALUE(AP1,0):PH1=VALUE(AP1,8)
```

Various Features for Interfacing External Devices

This analyzer provides various functions of interfacing external devices, for example, GP-IB, RS-232, printer port, VGA monitor output, etc., are standard. Further, the parallel port built into the analyzer, which is capable of controlling automated equipment without an external controller, provides two channels of 8-bit output ports and two channels of 4-bit inputs and outputs.



Software Fixture (Optional)

A recent rapidly increasing demand on RF components of balanced type presents hard challenge to enhanced accuracy and efficiency of measurements. The software fixture measures accurately responses from balanced components by using a network analyzer consisting of unbalance circuits, thus providing

a new solution to measure circuits other than standardized $50\ \Omega$ series. The matching network function provides simulations to find ideal matching constants.

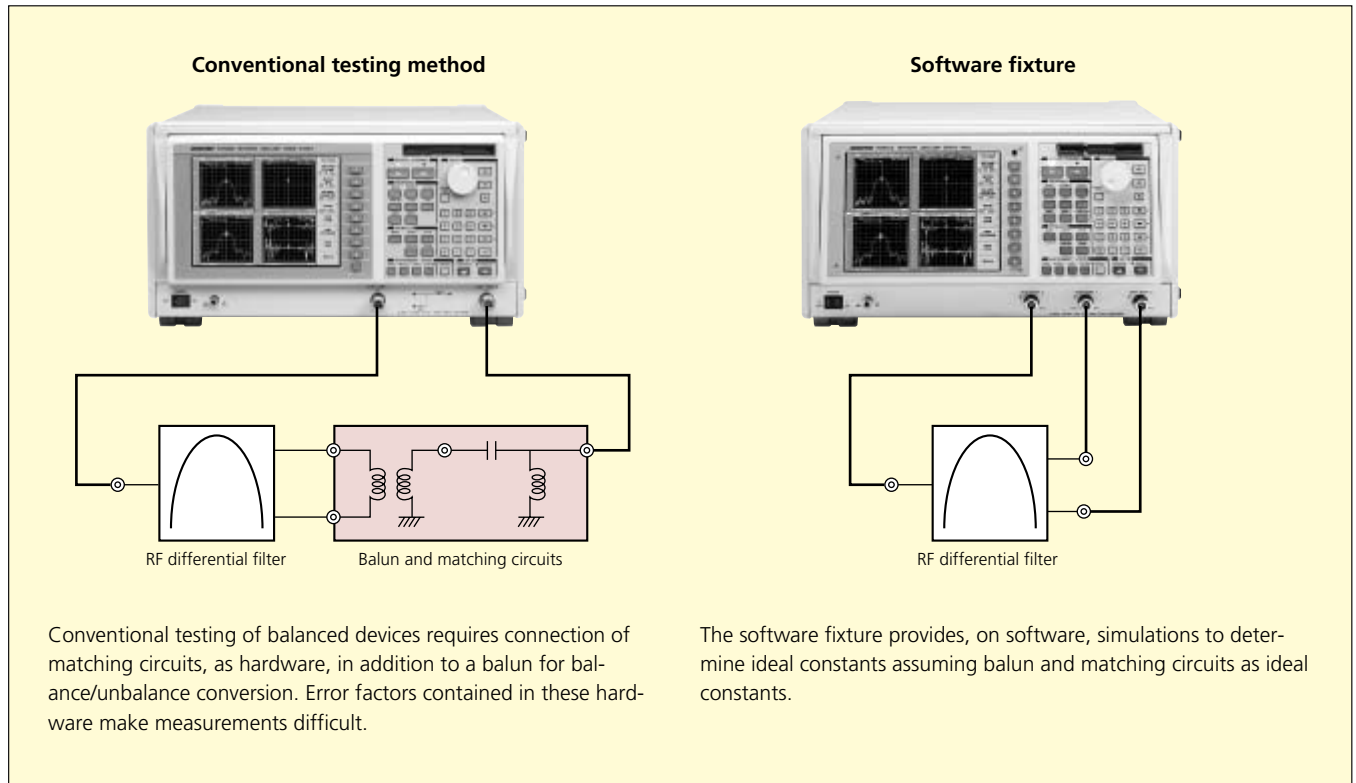

Impedance Conversion

Conventional testing requires hardware such as an impedance converter or that sort. On the contrary, this impedance converter converts measurement results provided by $50\ \Omega$ system into any standardized impedance in real time by operation performed on software.

Port Conversion

This function provides substantial enhancement to efficiency of testing balanced devices. This function makes it possible, upon acquisition of S parameters at the single input system, to analyze accurately and yet at high speed the characteristic as converted to number of ports as balanced device through operation.

Data Storage

Measurement results can be stored onto a T.S formatted floppy disk. The format of S parameters can be selected LogMag or Phase, and Real or Imaginary.

Matching Network

Analysis of the matching network that is the essential for determination of matching characteristic of filters and amplifiers can be now simulated on network analyzers. Characteristics added by matching constants that can be set at option can be measured in real time.

Balanced Level Measurement Function

This function measures the balanced level of the amplitude and the phase of transmission characteristics. When the balance level is in an ideal condition, the amplitude becomes 0 dB and the phase 0 dB.

Model Selection



Model with built-in 5 parameter test set

S11, S21, S22, S12
S11 & S21
S22 & S12

This model is equipped with S parameter test set and, therefore, capable of measurements of transmission/reflection characteristics in forward/reverse directions. The same as B Type, the monitor provides 4- channels, thus making this type capable of analyzing formats of Smith chart, polar chart and so on, in addition to analysis of gain characteristics of 4 parameters.

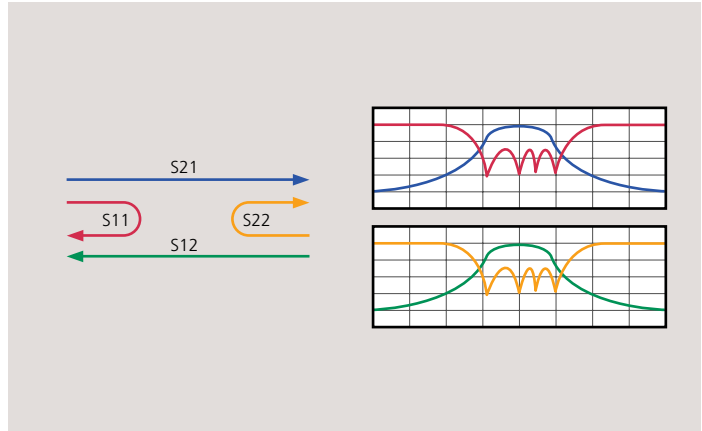

Model with built-in 3-port test set

+OPT.11

S11, S21, S22, S12
S11, S31, S33, S13
S22, S32, S33, S23
S11 & S21, S22 & S12
S11 & S31, S33 & S13
S22 & S32, S33 & S23

This type is equipped with a built-in 3-port test set. In the measurement of 3-port devices, it requires analysis of maximum 9 parameters. Using jointly the 4 display channels and twin-measure function enhances substantially the analysis efficiency.

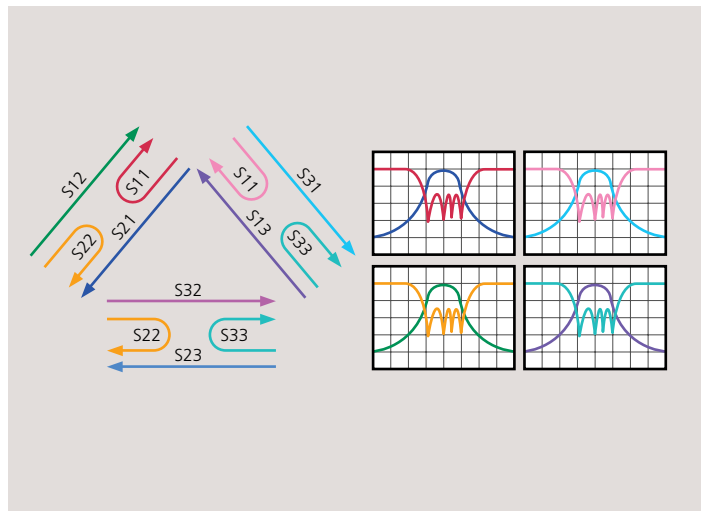

Model with built-in 4-port test set

+OPT.14

S11, S21, S22, S12
S11, S31, S33, S13
S22, S32, S23, S33
S11, S41, S14, S44
S22, S42, S24, S44
S33, S43, S34, S44
S11 & S21, S11 & S31, S22 & S32
S22 & S12, S33 & S13, S33 & S23
S11 & S41, S22 & S42, S33 & S43
S44 & S14, S44 & S24, S44 & S34

The 3765CG/3767CG OPT.14 has a built-in 4-port test set. Since this test set can fully calibrate all four ports of a 4-port device with up to 16 parameters, high accuracy measurements are made possible. Also since the measurements are performed by automatically switching connection paths 6 times, complicated parameters can be analyzed at high speed with great facility. Accordingly, a wide variety of applications such as two filter measurements at a time, dual band device measurements, etc. are possible.

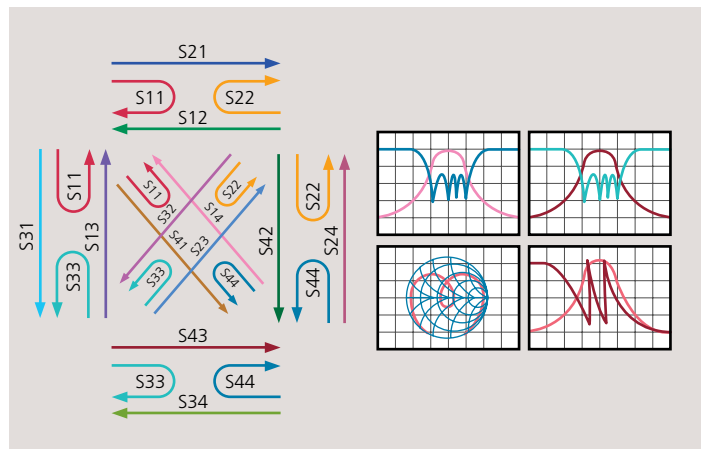

R3967 Multi-port Testing Adapter



Using this product with the network analyzer R3765CG/3767CG OPT.11 (3 ports), two functions described in the R3967 OPT.11 below and a calibration function can be used. Since these functions store only calibration data and measurement conditions (RESPONSE, STIMULUS), in contrast to previous save or recall functions, super-high-speed measurement switching are made possible. The testing adapter is available in 5 or 6 port types. ADVANTEST customizes the products beyond these products to suit your specifications. If you think you need a custom product, please contact us.

R3967 OPT.10

The R3967 OPT.10 is 5-port test set capable of measuring the transmission and reflection characteristics of 5-port devices, while connecting with the R3765CG/R3767CG OPT.11 network analyzer.

R3967 OPT.11

The R3967 OPT.11 is 6-port test set capable of measuring the transmission and reflection characteristics of two duplexers, while connecting with the R3765CG/R3767CG OPT.11 network analyzer.

R3967 OPT.12

The R3967 OPT.12 is 6-port test switch capable of measuring the transmission and reflection characteristics of 5 or 6-port devices, and even the measurement paths of 3Rx&Tx-Rx isolation, while connecting with the R3765CG/R3767CG OPT.11 network analyzer. This adapter is best suited for measuring multi-port devices such as dual-band couplers, and triple-band antenna switches.

Application Software

ADVANTEST supports various software applications that are created in conformance to customer specifications, as well as the manufacturing and sales of network analyzers. Examples of

application software are shown below. Please feel free to contact us.

Software for Displaying Multi-marker List

This is software that makes possible of moving position of displaying numerical values of markers to optional display area. In addition to an option for moving a marker display areas by each channel, provided are options for selecting ON/OFF for unit display and selecting ON/OFF for frequency display function.

Items Subject to Setting

- ①Marker frequency (ON/OFF)
- ②Marker Unit (ON/OFF)
- ③Marker List (ON/OFF, setting by channels is possible)
- ④Position of displaying markers (moving displaying position by channels is possible)

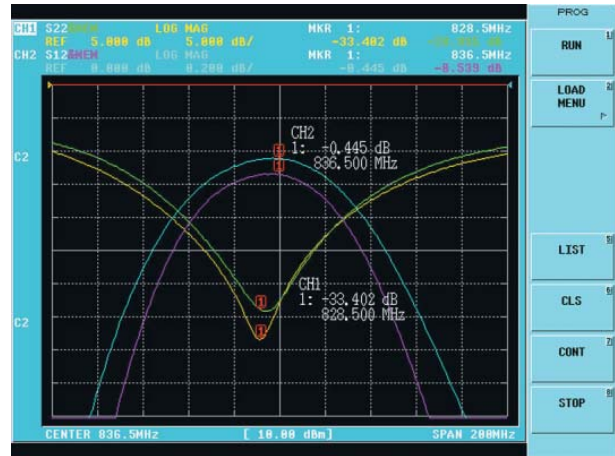

Software for Measuring Characteristic of Coaxial Cable

Various characteristics of coaxial cables are measured. For such measurements, used is the reflection method, thus making possible of calibration of measuring system. It is effective to measure return loss of antenna installed at remote locations. This software has broad use for the construction and maintenance of a communications base station.

(No need to connect the feed-back cable from the cable-end, calibration "OPEN", "SHORT", "LOAD" at the cable-end are enough.)

Items Subject to Measurement

- ①Through loss (Insertion loss)
- ②VSWR
- ③Return loss
- ④Electrical length
- ⑤Difference in electrical length between reference cable and cable under test.

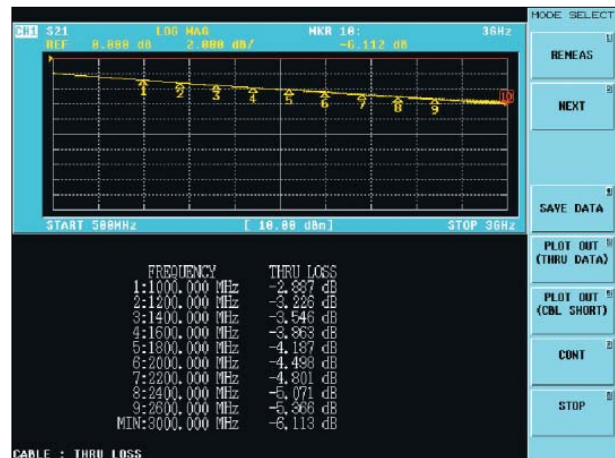

Software for Displaying Magnified Character

This is software for displaying magnified character of any data being tested. It is effective for confirmation of numerical values for specific items when such confirmation is regarded important. Items to be displayed can be selected, arbitrary on BASIC program.

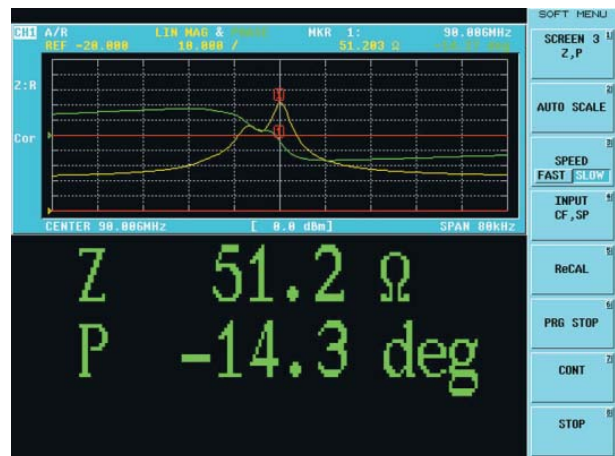

Specifications

Measuring Function

Sweep Channel:	2 channels (CH1, CH2)
Display Channel:	4 channels (CH1, CH2, CH3, CH4)
Trace:	2 traces/channels (Maximum 8 traces can be displayed in a screen)

Measuring Parameters

R3765CG/3767CG:	S11, S21, S12, S22
OPT.11/13:	S11, S22, S33, S21, S12, S31, S13, S23, S32
OPT.14:	S11, S22, S33, S44, S21, S31, S41, S12, S32, S42, S13, S23, S43, S14, S24, S34

Parameters can be converted to impedance (Z), admittance (Y).

Measurement Formats

Orthogonal Coordinates Display:	Amplitude (linear/logarithm), phase, groupdelay, VSER, complex number (real number/imaginary number),
Smith Chart:	Marker read out values are linear/logarithmic amplitude, phase, complex number (real number/imaginary number) R + jX, G + jB
Polar Coordinate Display:	Marker read out values are linear/logarithmic amplitude, phase, complex number (real number/imaginary number)

Signal Source Characteristic

Frequency

Range	
R3765CG:	300 kHz to 3.8 GHz
R3767CG:	300 kHz to 8.0 GHz
OPT.12/13	
R3765CG:	300 kHz to 3.8 GHz
Setting Resolution:	1 Hz
Measuring Resolution:	±0.01 ppm
Accuracy:	±10 ppm (23 ±5°C)
Temperature Stability:	±7.5 ppm (0 to 55°C, typical)
Long Range Stability:	±3 ppm (year, typical)

Output Power

Range	
R3765CG/3767CG:	+10 to -10 dBm
OPT.12/13:	+4 to -16 dBm
OPT.14:	+8 to -10 dBm
OPT.10/10 + 11:	+5 to -15 dBm (ATT FIX) +5 to -75 dBm (ATT AUTO)
OPT.10 + 12/10 + 13:	-1 to -21 dBm (ATT FIX) -1 to -81 dBm (ATT AUTO)
OPT.10 + 14:	+3 to -15 dBm (ATT FIX) +3 to -75 dBm (ATT AUTO)
Resolution:	0.01 dB

Accuracy

R3765CG/3767CG:	±0.5 dB (50 MHz, 0 dBm, 23 ±5°C)
OPT.10/10 + 11/10 + 14:	±0.5 dB (50 MHz, -5 dBm, 23 ±5°C)
OPT.12/13:	±0.5 dB (50 MHz, -6 dBm, 23 ±5°C)
OPT.10 + 12/10 + 13:	±0.5 dB (50 MHz, -11 dBm, 23 ±5°C)

For OPT.11/13/14 specified at TEST PORT 1
For OPT.10 specified at ATT = 0 dB

Flatness:

2.0 dBp-p (23 ±5°C)
For OPT.10 specified at ATT = 0 dB
For OPT.11/13/14 specified at TEST PORT 1

Linearity

R3765CG/3767CG:	
300 kHz to 15 MHz;	±0.4 dB (-5 to +5 dBm, 0 dBm Reference 23 ±5°C) ±0.8 dB (-10 to +10 dBm, 0 dBm Reference 23 ±5°C)
15 MHz to 8 GHz;	±0.2 dB (-5 to +5 dBm, 0 dBm Reference 23 ±5°C) ±0.4 dB (-10 to +10 dBm, 0 dBm Reference 23 ±5°C)
OPT.10/10 + 11:	
300 kHz to 15 MHz;	±0.6 dB (-10 to 0 dBm, -5 dBm Reference 23 ±5°C) ±1.3dB (-15 to +5 dBm, -5 dBm Reference 23 ±5°C)
15 MHz to 8 GHz;	±0.4 dB (-10 to 0 dBm, -5 dBm Reference 23 ±5°C) ±0.6 dB (-15 to +5 dBm, -5 dBm Reference 23 ±5°C)
OPT.12/13:	
300 kHz to 15 MHz;	±0.4 dB (-11 to -1 dBm, -6 dBm Reference 23 ±5°C) ±0.8 dB (-16 to +4 dBm, -6 dBm Reference 23 ±5°C)
15 MHz to 3.8 GHz;	±0.2 dB (-11 to -1 dBm, -6 dBm Reference 23 ±5°C) ±0.4 dB (-16 to +4 dBm, -6 dBm Reference 23 ±5°C)
OPT.10 + 12/10 + 13:	
300 kHz to 15 MHz;	±0.6 dB (-16 to -6 dBm, -11 dBm Reference 23 ±5°C) ±1.3 dB (-21 to -1 dBm, -11 dBm Reference 23 ±5°C)
15 MHz to 3.8 GHz;	±0.4 dB (-16 to -6 dBm, -11 dBm Reference 23 ±5°C) ±0.6 dB (-21 to -1 dBm, -11 dBm Reference 23 ±5°C)
OPT.14:	
300 kHz to 15 MHz;	±0.4 dB (-5 to +5 dBm, 0 dBm Reference 23 ±5°C) ±0.8 dB (-10 to +8 dBm, 0 dBm Reference 23 ±5°C)
15 MHz to 8 GHz;	±0.2 dB (-5 to +5 dBm, 0 dBm Reference 23 ±5°C) ±0.4 dB (-10 to +8 dBm, 0 dBm Reference 23 ±5°C)
OPT.10 + 14:	
300 kHz to 15 MHz;	±0.6 dB (-10 to 0 dBm, -5 dBm Reference 23 ±5°C) ±1.3dB (-15 to +3 dBm, -5 dBm Reference 23 ±5°C)
15 MHz to 8 GHz;	±0.4 dB (-10 to 0 dBm, -5 dBm Reference 23 ±5°C) ±0.6 dB (-15 to +3 dBm, -5 dBm Reference 23 ±5°C)

For OPT.10 specified at ATT = 0 dB

Attenuation Accuracy

OPT.10/10 + 11/10 + 12/
10 + 13/10 + 14:

ATT 20 dB (ATT FIX)
±4 dB (ATT = 0 dB Reference 23 ±5°C)
ATT 40 dB (ATT FIX)
±5 dB (ATT = 0 dB Reference 23 ±5°C)
ATT 60 dB (ATT FIX)
±6 dB (ATT = 0 dB Reference 23 ±5°C)
Specified at TEST PORT1

Signal Purity

Harmonic Spurious: 20 dBc (at maximum power, 23 ±5°C)
Non-Harmonic Spurious: 30 dBc (at maximum power, 23 ±5°C)
OPT.14: 30 dBc
(at maximum power, >1 MHz offset 23 ±5°C)
Phase Noise (10 kHz): 85 dBc/Hz (300 kHz to 40 MHz, 23 ±5°C)
85 dBc/Hz + 20 Log (f/40 MHz)
(40 MHz to 8 GHz, 23 ±5°C)
OPT.12/13: 85 dBc/Hz +20Log (f/40 MHz)
(40 MHz to 3.8 GHz 23 ±5°C)

Sweep Function

Sweep Type: Linear sweep, log sweep, program sweep,
power sweep
Sweep Time: 150 µs/point
Number of Points: 3, 5, 11, 21, 51, 101, 201, 301, 401, 601,
801, 1201 points
Sweep Trigger: Continuous, single, hold, external trigger

Characteristic of Reception Assembly

Resolution Bandwidth: 10 Hz to 20 kHz
(variable by 1, 1.5, 2, 3, 4, 5, 7 steps)

Stability

Trace Noise: 0.003 dBrms
(300 kHz to 2.6 GHz, RBW 3 kHz, typical)
0.006 dBrms
(2.6 GHz to 3.8 GHz, RBW 3 kHz, typical)
0.012 dBrms
(3.8 GHz to 8.0 GHz, RBW 3 kHz, typical)
OPT.12/13: 0.014 dBrms
(300 kHz to 2.6 GHz, RBW 3 kHz, typical)
0.022 dBrms
(2.6 to 3.8 GHz, RBW 3 kHz, typical)
Temperature Stability: 0.01 dB/°C (300 kHz to 2.6 GHz, typical)
0.02 dB/°C (2.6 GHz to 8.0 GHz, typical)
Long Range Stability: 0.005 dB/week (typical)

Amplitude Characteristic

Amplitude Resolution: 0.001 dB
Frequency Characteristic: ±1.0 dB (23 ±5°C)
Dynamic Accuracy: Based on -20 dB reduction from the
maximum power
0.20 dB (0 to -10 dB, 300 kHz to 3.8 GHz)
0.40 dB (0 to -10 dB, 3.8 GHz to 8.0 GHz)
0.05 dB (-10 to -50 dB)
0.10 dB (-50 to -60 dB)
0.40 dB (-60 to -70 dB)
1.00 dB (-70 to -90 dB)

OPT.12/13
R3765CG:

With an input power level of +4 dBm
considered to be a 0 dB level, a reduction
of -32 dB from that level is the reference
0.2 dB (-12 to 0 dB) Typical
0.05 dB (-42 to -12 dB)
0.2 dB (-52 to -42 dB)
0.7 dB (-62 to -52 dB)
2.0 dB (-72 to -62 dB)

Phase Characteristic

Phase Resolution: 0.01°
Frequency Characteristic: ±5° (23 ±5°C)
Dynamic Accuracy: Based on -20 dB reduction from the
maximum power
2.0° (0 to -10 dB, 300 kHz to 3.8 GHz)
4.0° (0 to -10 dB, 3.8 GHz to 8.0 GHz)
0.3° (-10 to -50 dB)
0.4° (-50 to -60 dB)
1.5° (-60 to -70 dB)
4.0° (-70 to -80 dB)
8.0° (-80 to -90 dB)

OPT.12/13
R3765CG:

With an input power level of +4 dBm
considered to be a 0 dB level, a reduction
of -32 dB from that level is the reference
2.0° (-12 to 0 dB) typical
0.3° (-42 to -12 dB)
0.5° (-52 to -42 dB)
1.0° (-62 to -52 dB)
3.0° (-72 to -62 dB)

Group Delay Characteristic

Range: Calculated by the following formula;
$$\tau = \frac{\Delta\theta}{360 \times \Delta f}$$
$$\Delta\theta = \text{Phase Difference}$$
$$\Delta f = \text{Frequency Difference}$$
$$(\text{Aperture frequency})$$

Group Delay Time Resolution: 1 pS
Aperture Frequency: [100/(Measured point - 1)] x 2% to 50%
of setting frequency range can be set
Accuracy: Phase accuracy/
(360 x aperture frequency (Hz))

Test Port Characteristic

Load Match:	16 dB (300 kHz to 40 MHz, 23 ±5°C) 18 dB (40 MHz to 2.6 GHz, 23 ±5°C) 16 dB (2.6 GHz to 3.8 GHz, 23 ±5°C)
OPT.12/13:	14 dB (3.8 GHz to 8.0 GHz, 23 ±5°C) 16 dB (300 kHz to 40 MHz, 23 ±5°C) 16 dB (40 MHz to 2.0 GHz, 23 ±5°C) 15 dB (2.0 to 3.8 GHz, 23 ±5°C)

Source Match:	14 dB (300 kHz to 40 MHz, 23 ±5°C) 16 dB (40 MHz to 2.6 GHz, 23 ±5°C) 15 dB (2.6 GHz to 3.8 GHz, 23 ±5°C) 12 dB (3.8 GHz to 8.0 GHz, 23 ±5°C)
OPT.12/13:	14 dB (300 kHz to 40 MHz, 23 ±5°C) 16 dB (40 MHz to 2.0 GHz, 23 ±5°C) 15 dB (2.0 to 3.8 GHz, 23 ±5°C)
OPT.10/10 + 11/10 + 14:	13 dB (300 kHz to 40 MHz, 23 ±5°C) 16 dB (40 MHz to 2.6 GHz, 23 ±5°C) 15 dB (2.6 to 3.8 GHz, 23 ±5°C) 12 dB (3.8 to 8 GHz, 23 ±5°C)

OPT.10 + 12/10 + 13 R3765CG:	13 dB (300 kHz to 40 MHz, 23 ±5°C) 16 dB (40 MHz to 2 GHz, 23 ±5°C) 15 dB (2 to 3.8 GHz, 23 ±5°C)
---------------------------------	---

Directivity:	28 dB (300 kHz to 40 MHz, 23 ±5°C) 30 dB (40 MHz to 2.6 GHz, 23 ±5°C) 26 dB (2.6 GHz to 3.8 GHz, 23 ±5°C) 22 dB (3.8 GHz to 8.0 GHz, 23 ±5°C)
OPT.12/13:	28 dB (300 kHz to 40 MHz, 23 ±5°C) 27 dB (40 MHz to 2.0 GHz, 23 ±5°C) 22 dB (2.0 to 3.8 GHz, 23 ±5°C)

Cross Talk:	90 dB (300 kHz to 40 MHz) 100 dB (40 MHz to 2.6 GHz) 90 dB (2.6 GHz to 3.8 GHz) 80 dB (3.8 GHz to 5.0 GHz) 70 dB (5.0 GHz to 8.0 GHz)
OPT.12/13:	85 dB (300 kHz to 40 MHz) 90 dB (40 MHz to 2.0 GHz) 90 dB (2.0 to 3.8 GHz)
OPT.14:	90 dB (300 kHz to 40 MHz) 95 dB (40 MHz to 2.6 GHz) 85 dB (2.6 to 3.8 GHz) 75 dB (3.8 to 5.0 GHz) 65 dB (5.0 to 8.0 GHz)

Maximum Input Level:	+12 dBm
OPT.12/13:	+20 dBm (R3765CG)

Noise Level:	(Range from maximum input level)
RBW 3 kHz;	-85 dB (300 kHz to 40 MHz) -90 dB (40 MHz to 3.8 GHz)
RBW 300 Hz;	-80 dB (3.8 GHz to 8.0 GHz) -95 dB (300 kHz to 40 MHz) -100 dB (40 MHz to 3.8 GHz) -90 dB (3.8 GHz to 8.0 GHz)

OPT.14:	
RBW 3 kHz;	-85 dB (300 kHz to 40 MHz) -85 dB (40 MHz to 3.8 GHz) -75 dB (3.8 to 8.0 GHz)
RBW 300Hz;	-95 dB (300 kHz to 40 MHz) -95 dB (40 MHz to 3.8 GHz) -85 dB (3.8 to 8.0 GHz)

Maximum Port Bias:	±30 Vdc, 0.5 A (only R3765CG/3767CG)
--------------------	--------------------------------------

Maximum Input Level:	+21 dBm, 30 Vdc
----------------------	-----------------

Test Port Connector:	Type N connector (female)
OPT.12/13:	Type N75Ω connector (female)

Display

Monitor:	8.4-inch TFT color LC monitor
Back Light:	Brightness half-life; (40000 H, typical)

Other Functions

Error correction:	Normalize, normalize & isolation, 1-port correction 2-port correction 3-port correction (OPT.11/13/14 only) 4-port correction (OPT.14 only) Average smoothing, smoothing Electrical length compensation, phase offset compensation
-------------------	---

Marker Function:	10 x Multi-marker Δ marker function, search function, marker function
------------------	---

Limit Line Function:	Can be set up to a Maximum of 31 segments PASS/FAIL display function, beep sound function
----------------------	---

Save Recall Function:	Register Type; saved to a maximum of 20 registers File Type; saved to floppy diskettes or internal memory (8 Mbytes)
-----------------------	--

Controller Function:	BASIC programming function (Program size; 2 Mbytes)
----------------------	--

FDD Function:	Conforms to MS-DOS FAT Type Format 2-mode compatible (DD 720 KB, HD 1.44 MB)
---------------	--

Connection With External Devices

For External Monitor:	15-pin D-SUB connector (VGA)
GPIB:	Conforms to IEEE488.1, IEEE488.2
Parallel Ports:	TTL level Output ports (8-bit x 2 ports) Input/output ports (4-bits x 2 ports)
Serial Ports:	Serial I/O for accessories
Printer Port:	Conforms to IEEE-1284-1994 (ESC/P J84, ESC/P Y2, PCL)
Keyboard:	Conforms to IBM PC-AT External Reference Frequency
Input:	1 MHz, 2 MHz, 5 MHz, 10 MHz (± 10 ppm) higher than 0 dBm (50 Ω)
Probe Power:	± 12 V ± 0.5 V, 300 mA

General Specification

Operational Environment

When FDD is used:	Temperature Range; +5 to +40°C Relative Humidity; 80% or less (no condensation allowed)
When FDD is not used:	Temperature Range; 0 to +50°C Relative Humidity; 80% or less (no condensation allowed)
Storing Conditions:	-20 to +60°C
Power Source:	100 VAC to 120 VAC, 50 Hz/60 Hz 220 VAC to 240 VAC, 50 Hz/60 Hz (Automatic switching between 100 VAC system and 200 VAC system)
External Dimensions:	Approx. 424 (W) x 220 (H) x 400 (D) mm
Mass:	Approx. 18.5 kg or less
Power Consumption:	250 VA or less
Accessories:	Operation Manual, Programming Manual, Power Cable, Fuse

Ordering Information

Network Analyzer	R3765CG	R3767CG
Frequency Range	300 kHz to 3.8 GHz	300 kHz to 8 GHz
Transmission Characteristic Measurement	●	●
Reflection Characteristic Measurement	●	●
S Parameter Measurement	●	●
Optional Hardware		
OPT.11 (Built-in 3-port Test Set)	▲	▲
OPT.14 (Built-in 4-port Test Set)*	▲	▲
OPT.10 (Output Attenuator)*	★	★
OPT.12 (75 Ω Impedance)*	▲	—
OPT.13 (75 Ω Impedance)*	For R3765CG + OPT.11	—
Optional Software		
OPT. 70 (Time Domain)	★	★
OPT. 71 (Software Fixture (Balance)) [☆] *	★	★
OPT. 72 (Software Fixture (Single))*	★	★

● Standard Function ★ Can be added individually, at option ▲ Either one can be added, at option

☆ OPT.71 requires an environment on R3765CG/3767CG which is added with either one of optional hardware OPT.11 or OPT.14.

Correction Kit for Error Correction	Model 9617S3	Model 9617A3 ¹⁾	Model 9617F3 ¹⁾	R17050
Impedance	75 Ω	50 Ω	50 Ω	50 Ω
Connector Type	BNC	Type N	3.5 mm	3.5 mm
Frequency	DC to 2 GHz	DC to 18 GHz	DC to 18 GHz	40 MHz to 8 GHz
Structure	BNC (f) Open BNC (m) Open BNC (f) Short BNC (m) Short BNC (f) Load BNC (m) Load Box	N (m) Open N (f) Open N (m) Short N (f) Short N (m) Load N (f) Load Box	3.5 mm (m) Open 3.5 mm (f) Open 3.5 mm (m) Short 3.5 mm (f) Short 3.5 mm (m) Load 3.5 mm (f) Load Box	Auto-Calibration Kit 3.5 mm (f) - (f) *OPT.04 3.5mm (m) - (m) *OPT.05 3.5mm (f) - (m) *OPT.06 Connector Cable Torque Wrench Box

¹⁾ Product of MAURY Corporation

* Please specify polarity of connector by either one of 04, 05 or 06.

Please be sure to read the product manual thoroughly before using the products.

Specifications may change without notification.