



MAP-220C LightDirect™ Chassis

Solve Your Optical Test Needs with a
Compact, 2-Slot Mainframe



The compact, 2U, two-slot MAP-220C LightDirect Chassis mainframe is designed for general fiber-optic lab use and smaller optical-manufacturer test-station deployments. It is as efficient and cost-effective as fixed-format versions, yet it maintains flexibility and modularity so you can build the application you need when you need it.



Benchtop (MAP-220C-A), rack-mount (MAP-220CX-A),
and reversed rack-mount chassis (MAP-220CXR-A)

Key Features and Benefits

- Compact, two-slot benchtop configuration
- Converts to rack mount — 2 RU high, one-half of a 19 in side-by-side format
- LXI-compliant interface with optional GPIB
- Local capacitive touch screen
- Field replaceable controller/ power-supply module
- Compatible with a wide range of MAP-200 optical test modules

Light Direct

For larger, more complex deployments, Viavi Solutions™ recommends the MAP-230B (three-slot) and MAP-280 (eight-slot) chassis systems. These chassis support all released MAP-200 modules.

The MAP-200 LightDirect Module Family

MAP-220C models host specific subsets of the broader MAP-200 module family that includes light sources, power meters, switches, and attenuators. These basic foundational modules serve as the key building blocks for most test applications. MAP-220C users can leverage these modules in a compact, benchtop format with a simple, intuitive graphical touch screen.

Light Sources



Light sources (mSRC-C1, mTLG-C1)

The 50 GHz tunable mTLG-C1 distributed feedback (DFB) laser is available in either C or L band, while the mSRC-C1 is a general-purpose light source in these key fixed telecom wavelength bands: 850, 1300, 1310, 1490, 1550, 1625 nm. These sources typically test system load or continuity, measure insertion loss, and test station calibration.

Power Meters



Optical power meters (mOPM-C1)

The mOPM-C1 optical power meters are available for all applications with one, two, or four power heads per module with four unique performance ranges. Models supporting +27 dBm input power complement versions with 110 dBm dynamic range.

Optical Switches



Optical switches (mOSW-C1)

The mOSW-C1 is the industry's gold standard for loss and repeatability. With over 80 variations available, there is a configuration ideally suited to all applications. Switches range from 1x2, 2x2, and 1x4 to 1x64 with options for internal power monitoring, direction monitoring, and power trim.

Attenuators



Variable optical attenuators (mVOA-C1)

The industry specification leader mVOA variable optical attenuator family has been enabling single-level control for receiver and amplifier testing for over 20 years. Available with one, two, or four variable optical attenuators (VOA) per module, with or without an internal power meter, the mVOA-C1 is also the industry's most compact modular solution.



Contact Us **+1 844 GO VIAVI**
(+1 844 468 4284)

To reach the Viavi office nearest you,
visit viavisolutions.com/contacts.

© 2015 Viavi Solutions Inc.
Product specifications and descriptions in this
document are subject to change without notice.
map220c-ps-lab-nse-ae
30175938 900 0714



MAP Optical Switch Solutions

mOSW-C1/mISW-C1

Manufacturing test automation is critical to reducing product costs and optical switches are at the heart of any automated test system. The Viavi Solutions mOSW-C1 Optical Switch Module and mISW Optical Switch Tray are built on the industry-leading, fourth-generation instrumentation class of Viavi optical switch technology. With more than 30 years of leadership in optical switching across network, monitoring, and manufacturing applications, the mOSW-C1/mISW-C1 represents a new milestone for performance and reliability with the industry's smallest footprint.

For the first time, the performance and repeatability found in large, fixed format 19-inch Viavi rack-mount systems are available in a modular plug-in or tray. Manufacturing engineers no longer have to choose between test system's size and its performance. Leveraging the mOSW-C1/mISW-C1 can reduce the size of switching systems by as much as 75% while still delivering the performance of much larger legacy systems. A 50% increase in switching speeds significantly saves testing time for connection-intensive architectures.

These switches are components of the MAP-200 family. With the widest range of optical modules in the industry, it is the most popular choice for manufacturing test automation across all optical industry segments. This includes the manufacture of passive components, transponders, and line cards. Advanced connectivity through remote VNC, Ethernet, GPIB, or local GUI makes the MAP-200 a natural choice for complex automation architectures because it dramatically simplifies debugging for remotely located manufacturing sites.

Key Benefits

- Provides all optical switching independently of data rate and transmission format
- Delivers minimal impact on system dynamic range regardless of switch size with low loss for all configurations from 1x2 to 1x176
- Flexible SCPI remote interface lets users program the switch using either MAP-200 style commands or maintain backward compatibility to the industry-standard Viavi SB/SC series optical switches
- Guarantees ultra-low 0.04 dB PDL and ± 0.005 dB repeatability to minimize measurement uncertainties on single-input versions
- New PTRIM option measures in-line power and adds up to 20 dB of coarse programmable loss on a connected port
- 1C, 2D (duplex), and 2E input configurations enable cost-saving architectures that reduce the number of switches required
- Expanded beam technology ensures multimode switches are "modally transparent" and do not disturb mode distributions, greatly simplifying transmission testing or testing with IEC-complaint mode launches

Applications

- Test system automation for multi-port components, modules, and line cards
- Manage complex manufacturing test sequencing
- Test for long-term reliability
- Paired with the MAP-200 mORL-A1 module to test multifiber connectors

Safety

- When installed in a MAP-200 chassis, MAP optical switches comply with CE, CSA/UL/IEC61010-1, and LXI Class C requirements.

Optical Performance

Switch Performance Improves Test Yield

Engineers developing automated test systems must consider the impact of the optical switch on the performance of the system under development.

To account for test uncertainties, the user must tighten the internal specification to ensure devices do not falsely pass. The necessary outcome is that a percentage of units are rejected, which could have been shipped to generate revenue. Test yield is defined as the percentage of devices that pass the internal specification relative to number of units that pass the external specification. These units are represented in zone B in Figure 1. The switch insertion loss (IL), polarization-dependent loss (PDL), repeatability, and stability all contribute to additional uncertainties in automated test systems. Selecting the mOSW-C1/mISW-C1 will minimize the switch impact on test yield, in many cases to unmeasurable levels.

Beware of switch solutions that are characterized using “typical” values and statistical performance. The Viavi mOSW-C1/mISW-C1 can guarantee “better-than” performance levels and provides test reports to prove it. Test system designers no longer have to speculate about potential worst-case impact. Unlike many competitors, mOSW-C1/mISW-C1 switches are never cascaded to create large channel counts. IL, PDL, and repeatability are the same, regardless of switch size, and deliver a true loss of 0.7 dB, greatly simplifying dynamic range impact calculations.

With 30+ years of history delivering the industry’s most repeatable switches, test engineers can be confident that the mOSW-C1/mISW-C1 will continue to perform to achievable limits.

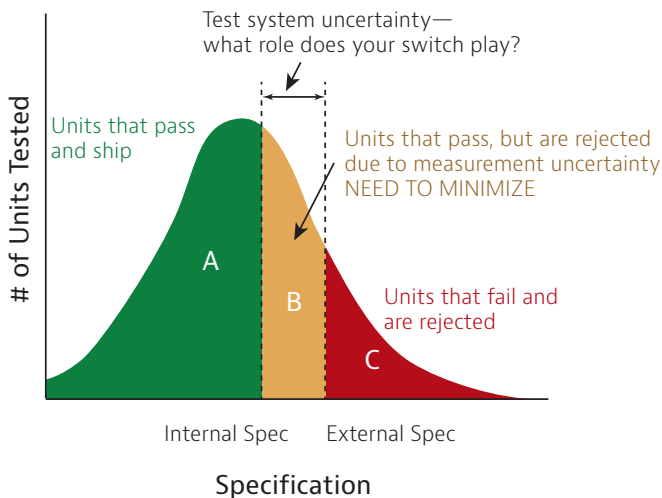

Figure 1. Measurement impact

For Both Single-Mode and Multimode Applications

The mOSW is available in single-mode (SM) and both standard multimode (MM) fiber types, OM1 (62.5 μm core) and OM3 (50 μm core), with specific design considerations built in for each type.

Unlike micro electro-mechanical system (MEMS) designs that use reflective switching techniques, the expanded Viavi beam design operates at the limit of polarization-dependent loss performance with virtually no wavelength-dependent loss.



mISW in MAP-204c

With the growth in data center and storage applications, multimode performance is a paramount concern for manufacturers. Modal-transparency, a term coined by Viavi in 2003, describes the interaction of the optical switch with the various transmitted optical modes. A switch that is modally transparent ensures that the entering mode profile remains undisturbed as it traverses the switch. This minimizes any spurious optical impairment during transmission tests where mode clipping or scattering into high-order modes can degrade BER performance. For IL testing applications, the mOSW-C1/mISW-C1 preserves the stringent IEC-specified launch conditions. Switch insertion loss is specified using IEC launch conditions to guarantee that it is the most reproducible switch device on the market.

Switching Time

Switching time can be separated into two key components. The first switching phase is the pure electro-mechanical time it takes to switch a connection (from break to make). The second switching phase is the settling time which is the time it takes to reach a stable insertion loss performing to the full level of the specification. Test designers who skip this second timing component are increasing their measurement uncertainty.

Viavi has carefully optimized the mOSW-C1/mISW-C1 to achieve the fastest possible switching time and still meet the requirements for optical performance. Through characterization of the settling dynamics, Viavi has designed the only switch on the market that details the stabilization timing. Knowing this, test engineers can confidently determine when to take measurements and how best to optimize measurement performance.

Power Trim Option (PTRIM)

Power Trim is a new option available for single-mode 1C versions with fewer than 80 ports that offers two new capabilities to simplify integration and remote troubleshooting, as shown in the examples in Figures 2 and 3.

Bidirectional Power Monitor

Optical power is displayed on the graphical user interface (GUI) next to the common port (Port 1) and indicates the transmission direction. The bidirectional power monitor automatically senses the use of the common port as input or output. In-line power monitors can greatly simplify remote troubleshooting in distant factories. Test engineers can remotely log in to the MAP-200 to verify the accuracy of power levels for any particular connected test path.

Loss Trimming

Users can increase the insertion loss for the connected optical path by up to 20 dB using a programmable Trim Index. The trimming function simplifies setting power levels without requiring exact precision. For example, level setting a signal into a receiver port during system test or bringing a laser signal out of the saturation region.

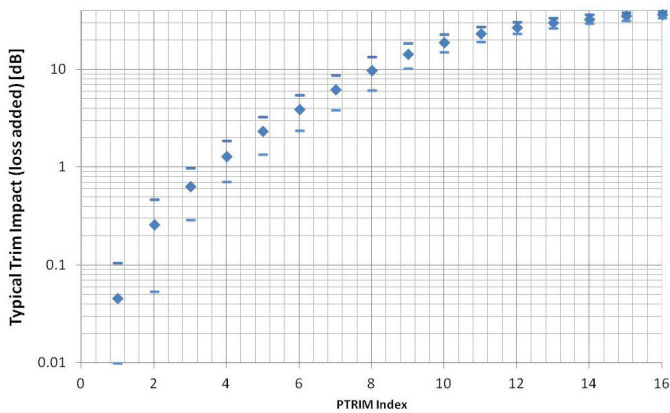

Figure 2. Typical PTRIM impact for 1CxN with 24 ports or fewer

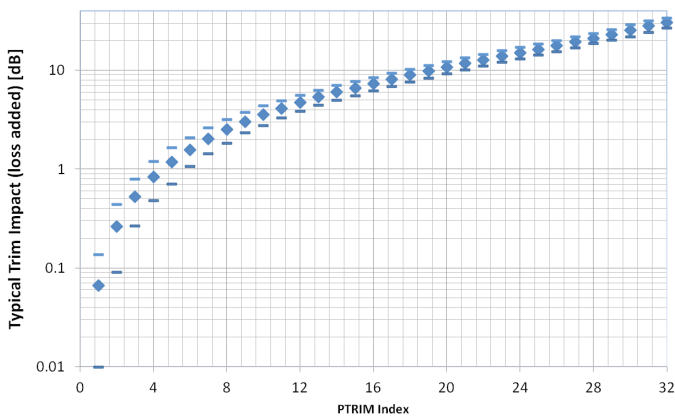

Figure 3. Typical PTRIM impact for 1CxN with more than 24 ports and fewer than 80 ports

Configurations that Reduce Cost

Size and Flexibility

The MAP-200 offers a large array of switch sizes and packaging options. The mOSW-C1 is optimized for smaller 1x2, 2x2, and up to 1x24 channel counts. Configuration selection will determine whether a single or dual-slot module is delivered, and modules are available in pigtail and bulkhead connector versions, as shown in Figure 4.

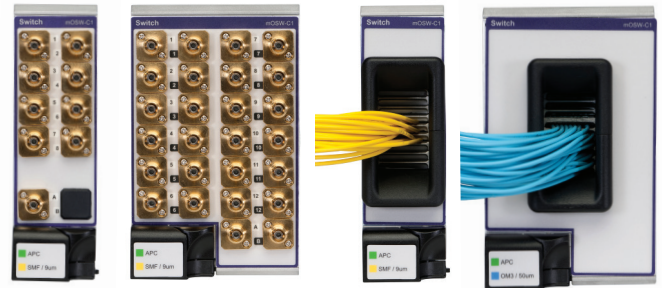

Figure 4. Single-width and dual-width modules with bulkhead followed by single-width and dual-width module with pigtail exits

Running the mOSW requires a MAP-200 chassis, available in 2-, 3-, or 8-slot rack-mounted or benchtop versions similar to the one shown in Figure 5.



Figure 5. An mOSW-C1 mounted in a MAP-200C.

Similar choices are available for the mISW-C1 switch tray. As Figure 6a and 6b shows, for fewer than 76 channel counts, the optical switch tray is delivered in a MAP-202C. The larger 4U MAP-204C accommodates up to 176 switch outputs. The chassis must be selected as part of the tray configuration. These systems are not modular; the tray is mounted in the chassis at the factory. Access is available, but only for service.

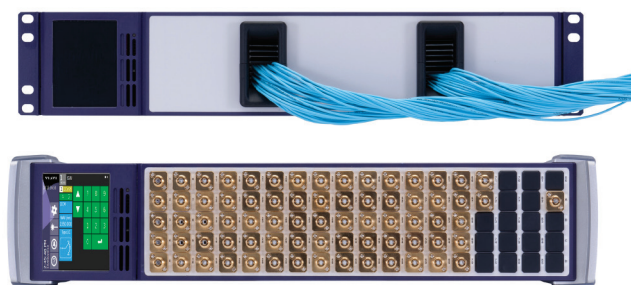

Figure 6a. A 2 RU MAP-202C with a bulkhead or pigtail.



Figure 6b. A 4U MAP-204C can be used for switches with more than 76 output ports.

Compact Design

The MAP-200 is the most compact optical test platform on the market today with designs that are often 75 percent smaller than traditional optical test equipment. Compact designs reduce production costs because they reduce the raw materials needed, reduce the number of mainframes required, and save space overall.

The compact form factor of the Viavi optical switch technology allows for packaging multiple independent switches in to a single MAP-200 module. For example, up to eight 1x2 modules can be packaged in a single-slot module, enabling sixty-four 1x2 switches in only 3U of 19-inch rack height. Alternatively, up to sixteen 1x4 modules can be packaged in the same space.

Minimizing the number of modules also saves on overall rack-system space, moving automated test systems from two bays to one. In a modern contract-manufacturing scenario, single-bay test systems are less costly to ship, easier to deploy, and require half the floor space.

Leveraging Switch Type (1C, 2D, 2E)

To simplify test system integration, the mOSW-C1/mISW-C1 supports three unique input types, shown in Figure 7:

- Standard single common input (1C type)
- Duplex input (2D type)
- Dual parallel input (2E type)

The D and E types are commonly referred to as “ganged” input switches. The relative positions of the A and B inputs are locked and cannot be changed. However, leveraging these multiple connected paths can potentially save costs.

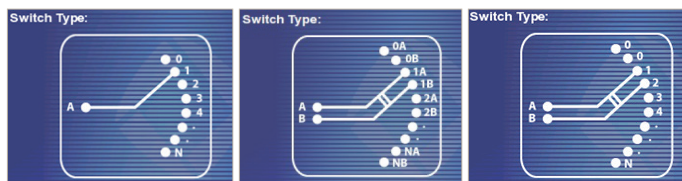

Figure 7. Single common (1C type), duplex (2D type), and dual parallel (2E type)

The duplex configuration is most powerful when test systems have well defined transmit (Tx) and receive (Rx) paths. As Figure 8 shows, one 2Dx4 can replace two 1Cx4 switches. Removing one switch reduces the relative test system costs, saving module space and greatly simplifying test sequencing (requiring only one command to select the Tx/Rx port under test). The advantage of using a 2E version is that it allows both A and B inputs to access all outputs; therefore, the 2E could be deployed as either a 2D or a 1C, depending on testing needs.

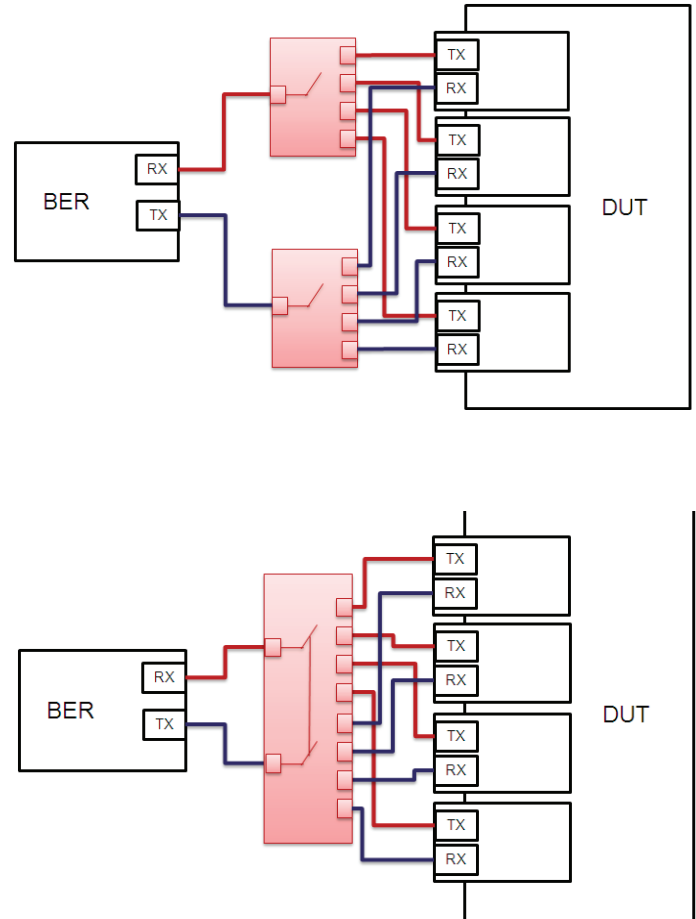

Figure 8. Converting a two 1Cx4 system to a single 2Dx4 system

Enhanced GUI and Labeling

While the majority of applications for the mOSW-C1/mISW-C1 will leverage the remote interface (which is backwards-compatible to the legacy mLCS-A1/A2), Viavi has also simplified the module for manual use. As Figure 9 shows, product labels are bright, high contrast, and easy to read. Latch labels clearly identify the fiber and connector type. Units with the pigtail option have 2 meter pigtails and use standardized fiber color-coding to identify the fiber type.



Figure 9. Dual-slot bulkhead switch

The revitalized GUI, shown in Figures 10a and 10b, has several simple powerful features for easier use. The novel “hover and release” channel selection lets users clearly see what port connection will be made, prior to selecting it. It clearly communicates the A and B paths at all times. A simple toggle interface is provided for 1x2 and 2x2 switches with only two states. In the detailed views, schematic diagrams of the switch type clearly communicate the topology of the switch type (1C, 2D, 2E) to eliminate guesswork during troubleshooting. A programmable connection table lets users identify which equipment is connected to which port, simplifying troubleshooting.

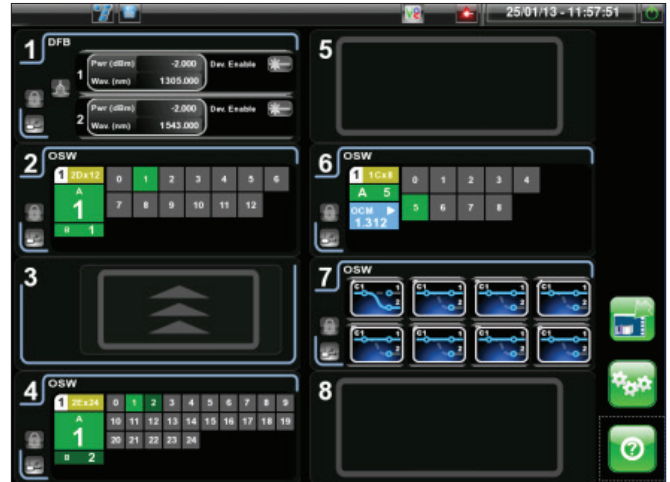

Figure 10a. Multimodule view of the MAP-200 GUI



Figure 10b. Detailed mOSW-C1 screen

Automation and Remote Interface

The long legacy of Viavi switches in the market requires consideration of existing automation frameworks. The mOSW-C1 is a drop-in replacement for the older mLCSs, and the new mISW-C1 retains compatibility with popular SB/SC switches.

Specifications

Optical and Environmental

mISW-C1, mOSW 1x4 Configurations and Larger

Parameter ¹	1C Configuration	2D Configuration	2E Configuration
Wavelength range			
Single-mode ² (SM)	1250 to 1650 nm		
Multimode ³ (MM)	760 to 1360 nm		
Insertion loss (IL)⁴			
Single-mode (SM)	0.7 dB	0.7 dB	0.9 dB
Multimode (MM)	0.9 dB	0.9 dB	1.0 dB
Return loss (RL)⁵			
Single-mode (SM)	62 dB	62 dB	60 dB
Multimode (MM), OM1 (62.5 μm)	30 dB	30 dB	25 dB
Multimode (MM), OM3 (50 μm)	40 dB	40 dB	35 dB
Polarization-dependent loss (PDL)⁶	0.04 dB	0.05 dB	0.07 dB
Repeatability⁷			
Sequential switching	±0.005 dB	±0.01 dB	±0.01 dB
Random switching	±0.025 dB	±0.04 dB	±0.04 dB
IL stability⁸ (maximum)	±0.025 dB		
Crosstalk (maximum)			
Single-mode (SM)	-80 dB		
Multimode (MM)	-60 dB		
Max input power (optical)	300 mW		
Lifetime	100 million switching cycles		
Switching time	≤ 24 ports	>24 ports < 72	>72 ports
Electro-mechanical (break to make)	20+10*(N-1) ms	55+30*(N-1) ms	35+11*(N-1) ms
Settling time to 90% final IL	60 ms	70 ms	90 ms
Settling time for 99% final IL	90 ms	120 ms	200 ms
Operation temperature	0 to 50°C		
Operation humidity	15 to 80% RH, 0 to 40°C noncondensing		
Storage temperature	-30 to 60°C		
Power trim option for single-mode⁹	1CxN9 with <72 ports		
Additional IL	0.6 dB		
Return loss	55 dB		
Additional through path PDL	0.02 dB		
Power measurement range	+10 to -55 dBm (1550 nm)		
Power trim range	20 dB (typical)		
Power trim index	0 to 16 (≤ 24 ports); 0 to 32 (>24 ports) (typical trim resolution shown below)		

*All specifications are presented for PTRIM index set to zero.

Notes:

- All optical measurements excluding connectors, taken after temperature has been stabilized for minimum of one hour, at ambient room temperature between 20–30°C and variation less than ±3°C
- For IEC 60793-2-50 Type B1.3/ISO 11801 OS2 compliant fiber, such as Corning SMF-28e
- For OM1 and OM3 fiber type compliant with ISO/IEC 11801
- Excluding connectors; tested at 1310 and 1650 nm for SM and 850 and 1300 nm for MM with IEC 62614 ED1.0 2010-compliant EF
- RL excluding the connectors with 2m pigtail length; tested at 1310/1625 nm for SM and 850/1300 nm for MM IEC 62614 ED1.0 2010-compliant EF
- PDL tested at 1310 and 1650 nm
- Measured between two consecutive readings over 100 cycles
- Any channel drift relative to reference channel at ±3°C deviation of ambient temperature over a 7-day period (168 hours)
- Typical power trim curve is characterized at 1550 nm for reference purposes only; actual performance could vary based on the channel and wavelength being operated

Specifications

Optical and Environmental

mOSW-C1,1x2 and 2x2

Parameter ¹	1x2	2x2
Wavelength range		
Single-mode ² (SM)	1290 to 1330 nm and 1520 to 1650 nm	
Multimode ³ (MM)	760 to 1360 nm	
Insertion loss (IL)⁴		
Single-mode (SM)	0.7 dB	1.2 dB
Multimode (MM)	0.9 dB	1.2 dB
Return loss (RL)⁵		
Single-mode (SM)	50 dB	50 dB
Multimode (MM), OM1 (62.5 μm)	30 dB	25 dB
Multimode (MM), OM3 (50 μm)	40 dB	35 dB
Polarization-dependent loss (PDL)⁶		
	0.07 dB	0.08 dB
Repeatability⁷		
	±0.02 dB	±0.03 dB
IL stability⁸(maximum)		
		±0.025 dB
Crosstalk (maximum)		
Single-mode (SM)	-55 dB	
Multimode (MM)	-55 dB	
Max input power (optical)		
	300 mW	
Lifetime		
	100 million switching cycles	
Switching time		
	Single-Mode	Multimode
Electro-mechanical (break to make)	4 ms	210 ms
Settling time for 90% final IL	2 ms	60 ms
Settling time for 99% final IL	4 ms	90 ms
Operation temperature		
	0 to 50°C	
Operation humidity		
	15 to 80% RH, 0 to 40°C noncondensing	
Storage temperature and humidity		
	-30 to 60°C noncondensing	

Notes:

1. All optical measurements, excluding connectors, taken after temperature has been stabilized for minimum of one hour, at ambient room temperature between 20 to 30°C with a variation of less than ±3°C.
2. For IEC 60793-2-50 Type B1.3/ ISO 11801 OS2 compliant fiber (for example, Corning SMF-28e).
3. For fiber type of OM1 and OM3 fiber compliant with ISO/IEC 11801.
4. Excluding connectors. Tested at 1310 and 1650 nm for SM and 850 and 1300 nm for MM with EF compliant with IEC 62614 ED1.0 2010.
5. RL excluding the connectors with 2 m pigtail length. Tested at 1310 and 1625 nm for SM and 850 and 1300 nm for MM with EF compliant with IEC 62614 ED1.0 2010.
6. PDL tested at 1310 and 1650 nm.
7. Measured between two consecutive readings over 100 cycles.
8. Drift of any channel relative to reference channel at ±3°C deviation of ambient temperature over a 7-day period (168 hours).

Specifications

Packaging

General		mOSW	
Dimensions (W x H x D)			
Single slot	4.1 x 13.3 x 37.0 cm (1.6 x 5.2 x 14.6 in)		
Dual slot	8.1 x 13.3 x 37.0 cm (3.2 x 5.2 x 14.6 in)		
Weight			
Single slot with pigtails	1.75 kg (3.14 lb)		
Dual slot with pigtails	3.1 kg (6.14 lb)		
Pigtail length on units with pigtails	2 m		
General		mISW	
	MAP-202C, 2U (< 72 ports)	MAP-204C, 4U (> 72 ports)	
Dimensions (W x H x D)	444 x 88.2 x 386.5 mm (17.5 x 3.5 x 15.2 in)	444 x 177 x 386.5 mm (17.5 x 7 x 15.2 in)	
Weight	13 kg (28.7 lb)	20 kg (44.1 lb)	



Contact Us **+1 844 GO VIAVI**
(+1 844 468 4284)

To reach the Viavi office nearest you,
visit viavisolutions.com/contacts.

© 2015 Viavi Solutions, Inc.
Product specifications and descriptions in this
document are subject to change without notice.
maposw-ds-lab-tm-ae
30173420 904 0515