

T-BERD®/MTS Multi-Services Application Module

Enabling Carrier Ethernet, Advanced IP, OTN, SONET/SDH, PDH and Fibre Channel Field Test



Multi-Services Application Module (MSAM)



T-BERD/MTS-6000A



T-BERD/MTS-8000

Key Benefits

- Reduces CapEx by combining multiple technologies and multi-test capabilities into one tool, including Ethernet, Fibre Channel, SONET/SDH, and PDH
- Protects investment with modular form-factor and field upgradeability to add modules or software options
- Provides technology and market-leading test capabilities for Carrier Ethernet and Mobile Backhaul applications
- Provides comprehensive troubleshooting capabilities used in services installation and fault isolation
- Reduce troubleshooting and turn-up times with automated Ethernet, IP, and TCP test applications that follow best practices and provide repeatable easy-to-understand results
- Provides multiple stream Ethernet testing for Layer 2 through 4 CoS verification for up to 10 streams
- Enables remote control via web browser and virtual network connection (VNC) and Command Line SCPI

The Multi-Services Application Module (MSAM) is the latest innovation for the award-winning, industry-leading T-BERD/MTS family of test solutions that provides the industry's most compact, modular multi-functional, multi-layer DS1 to 10-Gigabit tester for designing, installing, and maintaining Carrier-Grade networks. The MSAM affords customers with these highly portable test sets the versatility needed to support Carrier Ethernet/IP, application layer TCP, VoIP, and IP video analysis, SONET/SDH, DSx/PDH, OTN and Fibre Channel in one platform. The MSAM now provides even more testing capabilities for Ethernet Backhaul, Metro Core telecom networks, cable provider switch centers, government telecommunication centers, and providers.

Test Interfaces

PDH	SONET/SDH and VCAT GFP	Ethernet	Fibre Channel	OTN	CPRI
DS0-PRI ISDN	OC3/STM-1	10/100/1000BaseT	1 G	OTU1, 2.7 G	3.1 Gbps Layer 1
DS1/E1	OC12/STM-4	100M Optical	2 G	OTU2, 10.7 G	
DS3/E3/STS-1e	OC48/STM-16	1GE Optical	4 G	OTU2e, 11.05 and 11.1 G	
E4/STM-1e	OC192/STM-64	10GE LAN/WAN	10 G	ODU Mux	

Ethernet IP Testing Lifecycle

Installation	<ul style="list-style-type: none"> • Enhanced RFC 2544, including frame delay variation, asymmetric rates, and concurrent results to reduce overall test time • Carrier Ethernet testing with Link and Service OAM (Y.1731), PBB/PBT, MPLS/VPLS, MPLS-TP, VLAN, Q-in-Q, and J-Proof Ethernet transparency • Verify Ethernet synchronization using 1588v2 PTP or G.826x-based Synchronous Ethernet
Troubleshooting	<ul style="list-style-type: none"> • Line rate packet capture up to 10 Gbps with WireShark decode • J-Mentor provides expert troubleshooting post capture analysis • J-Profiler provides automatic traffic explorer with top talkers analysis
Application	<ul style="list-style-type: none"> • Data: Automated Layer 4 application testing with TCP TrueSpeed™ (64 sessions and line rates up to 10 Gbps) based on industry best practices • Voice: VoIP call placement and QoS analysis emulates the true end-user experience at line rates up to 10 Gbps • Video: IPTV and MicroSoftTV QoS testing monitors, analyzes, and identifies which layer of the network is causing issues



Ethernet IP Applications

- Troubleshoots Ethernet/IP networks, captures and analyzes packets, monitor traffic to identify and categorize top talkers by flow, and identify the types of devices on the network
- Tests Carrier Ethernet transport to verify class of service (CoS), Triple-Play Service, and Ethernet circuit transparency
- Emulates a 1588v2 master clock/slave recovery to ensure proper PTP message propagation and guarantee accurate timing with packet delay variation (PDV) with background traffic loads
- Verifies accurate SyncE frequency synchronization as well as ESMC message propagation
- Confirms higher-layer Ethernet data applications and services at 10 Mbps to 10 Gbps rates with IPv4, IPv6, automated TCP WireSpeed testing with stateful emulation, HTTP page throughput, and FTP throughput
- Places and receives VoIP calls to verify audio QoS and real end-user experience supporting SIP, Cisco SCCP, or H.323 signaling
- Analyzes video content and transport statistics for up to 32 MPTS or 512 SPTS MPEG IPTV streams or 16 multicast MSTV streams to verify whether issues are related to video content or IP transport as well as verify MSTV QoS and measure Instant Channel Change (ICC) latency
- Tests Layer 1-3 Ethernet/IP SLAs with RFC 2544 for up to 8 VLAN tags, Q-in-Q, VPLS, and MPLS/VPLS encapsulation
- Tests 10 GigE LAN and WAN-PHY interfaces at 850, 1310, and 1550 nm wavelengths, and supports 50 GHz C-Band Tunable XFPs

Additional Transport Applications

- Verifies Ethernet services transported via SONET/SDH using NewGen (VCAT, GFP, and LCAS) with differential delay measurements
- Tests OTN OTU interfaces at 2.7, 10.7, 11.05, and 11.1 Gbps bit rates with SONET/SDH and Ethernet clients including testing OTN multiplexing of ODU1 inside OTU2 interfaces
- Tests SONET/SDH at OC-3/STM-1 through OC-192/STM-64 line rates including service disruption measurements and POH capture with triggers
- Conducts BER testing, service disruption, and circuit monitoring on T-carrier and PDH interfaces and mappings (T1, E1, E3, DS3, and E4)
- Provides fractional T1/E1, DS0 BER, signaling analysis, including Nx56 and Nx64 framing rates
- Confirms ISDN DS1 PRI interfaces by emulating TE and NT equipment, decoding D Channel, and placing/receiving voice calls
- Verifies electrical jitter for DS1/DS3 and E1/E3/E4/STM1e interfaces including output jitter, jitter tolerance, and jitter transfer
- Enables automated testing of 1G/2G/4G/10G Fibre Channel interfaces for SANs with RFC 2544-like script that includes buffer-to-buffer control verification and Fibre Channel (FC) login
- Proves transport quality of CPRI 3.1 Gbps using BER stress test patterns and latency measurements



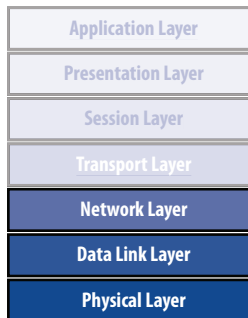

Carrier Ethernet Installation Testing

For years Ethernet/IP has been transported throughout carrier networks encapsulated in other data-link layer technologies that evolved into a carrier-grade technology because of operations, administration, and maintenance (OAM) standards such as ITU-T Y.1731, IEEE 802.1ag, and 802.3ah. Ethernet now possesses many of the characteristics that made SONET/SDH the transport technology of choice: end-to-end circuit transparency, redundancy, and full-featured OAM for circuit-based performance management and alarming. The MSAM delivers a much-needed tool set for provisioning and troubleshooting Ethernet networks that substantially improves installation and troubleshooting times, thereby guaranteeing error-free operation and a significant reduction in operating expense (OpEx).

Highly Accurate One-Way Delay Measurements

The One-Way Delay test option helps Cell Site Ethernet backhaul providers, mission-critical government agencies, and financial institutions measure the delay of Ethernet, IPv4, and IPv6 traffic received from senders using a highly accurate CDMA receiver. Delays for transmitted information may differ from that of information received because of the different paths traffic can take as it travels across the network or the way in which devices buffer or prioritize it. The MSAM can detect asymmetric traffic delays and attain accuracies 10 times greater than most common service level agreements (SLAs) saving hours of troubleshooting. These capabilities also enable Ethernet network providers to differentiate their offerings and enable network planners to understand the delay tolerances that affect their applications.

Enhanced RFC 2544 Testing

The MSAM delivers all the Carrier Ethernet testing needed to qualify Ethernet-based transport networks. RFC 2544 is the defacto industry standard for Ethernet circuit installation. In addition to supporting Ethernet throughput or committed information rate (CIR), frame delay (FD) or latency, frame loss (FLR), and back-to-back burst testing as called out in the RFC, the MSAM also tests for packet jitter or frame delay variation (FDV) to ensure the circuit is ready to transport time-sensitive services such as IPTV and VoIP. JDSU-enhanced RFC testing enables the measurement of CIR, FD, and FDV concurrently to reduce test time by more than 60 percent as well as delivers a new zeroing-in algorithm that more quickly establishes the maximum throughput of an Ethernet virtual circuit (EVC). Using a pair of test sets and Asymmetric RFC testing, users can validate EVCs with different upstream and downstream CIRs, or they can test sequentially in both directions to ensure that key performance indicators (KPIs) are met across any connection type.

J-QuickCheck your circuit prior to RFC

J-QuickCheck can perform a fast pre-selective circuit qualification prior to running an RFC test that quickly confirms the port duplex setting and end-to-end circuit connectivity and estimate the attainable throughput, thus saving technicians valuable time. Too often these basic issues halt or delay the workflow of installation testing negatively impacting OpEx.

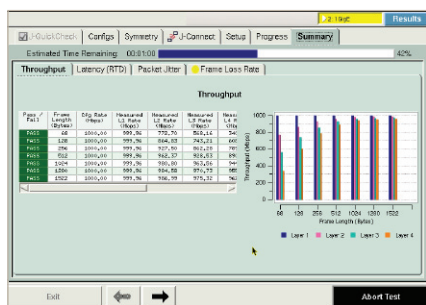

Enhanced RFC 2544 Testing

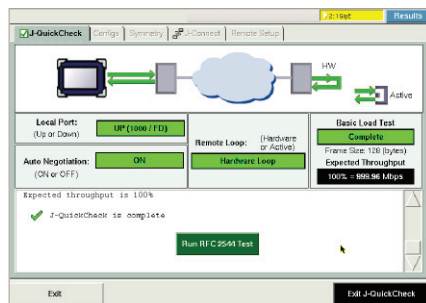

J-QuickCheck

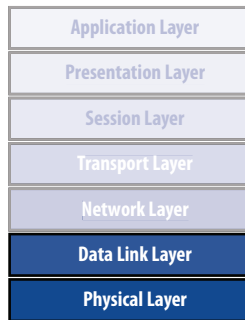

Ethernet OAM, VLAN, Q-in-Q, VPLS, MPLS, and PBB/PBT Tunneling Technologies

Ethernet tagging and encapsulation is commonly used to improve the scalability of Ethernet networks by isolating customer traffic and, in the case of provider backbone bridging (PBB), minimizing the number of MAC addresses that equipment must learn. Regardless of the encapsulation and tagging used, the MSAM tests Class of Service (CoS) to confirm KPIs such as CIR, FD, FDV, and FLR. Support for virtual local area network (VLAN) tags, Q-in-Q VLAN tags, PBB (also known as MAC-in-MAC) and multi-protocol label switching (MPLS)/virtual private LAN service (VPLS), the Transport module enables testing at any part of the Metro network. It supports MPLS-TP traffic generation and QoS analysis and simultaneously verifies OAM Label 13 or 14 operation including continuity check messages (CCM) and loopback/ linktrace (LB/LT). The VLAN Scan Tool automates the process of confirming that multiple ranges of VLANs are passing traffic.

J-Proof Ethernet Transparency Test

J-Proof is a Carrier Ethernet test that can confirm end-to-end transparency of Ethernet between two end points anywhere on a network using slow protocol data unit (PDU) generation that will not interrupt an existing service. Service providers can use J-Proof to confirm the transparent transport of control plane messages such as STP, GARP, and many of the Cisco proprietary protocols in use today, such as CDP and VTP. A powerful, customizable Ethernet frame generator tests the transparency of almost any Ethernet control plane message, even when a pre-defined frame is not available. Testing with J-Proof enables customers to guarantee that an intermediate network is not filtering their control plane traffic.

Link and Service Ethernet OAM (Y.1731)

The Ethernet OAM features of the MSAM were designed for technicians who install and troubleshoot Ethernet circuits to deliver end-to-end connectivity fault management (CFM) including connectivity check messages, Ethernet loopback, and link trace generation and analysis. For testing cell site Ethernet backhaul and Ethernet business services, technicians can install and troubleshoot Ethernet circuits using CFM tests based on IEEE 802.1ag and ITU Y.1731 standards.

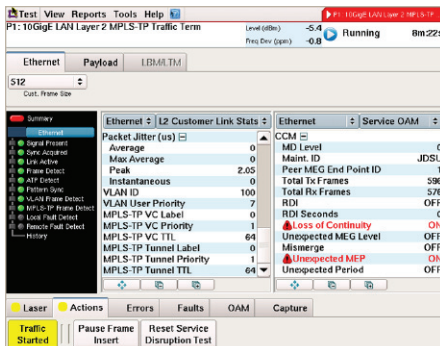

Verifying MPLS-TP with OAM

Ethernet Timing Synchronization Verification using 1588v2 PTP and G.826x SyncE

Critical network timing and frequency synchronization testing enables service providers to analyze emerging 1588v2 PTP and Synchronous Ethernet (SyncE) protocols greatly reducing expenses for mobile backhaul and LTE by eliminating the need for TDM/GPS. Wireless backhaul providers can now verify whether Ethernet links can transfer PTP protocols by connecting to a PTP master and measuring critical packet parameters such as PDV with simultaneous network traffic loading. SyncE testing recovers the timing of an incoming Ethernet interface for the tester's

transmitter. Capturing and decoding the 1588v2 PTP and Ethernet Synchronization Messaging Channel (ESMC) messages allows operators to verify and troubleshoot proper configuration and operation of synchronization networks.

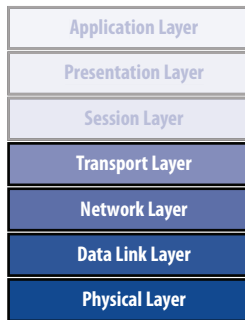
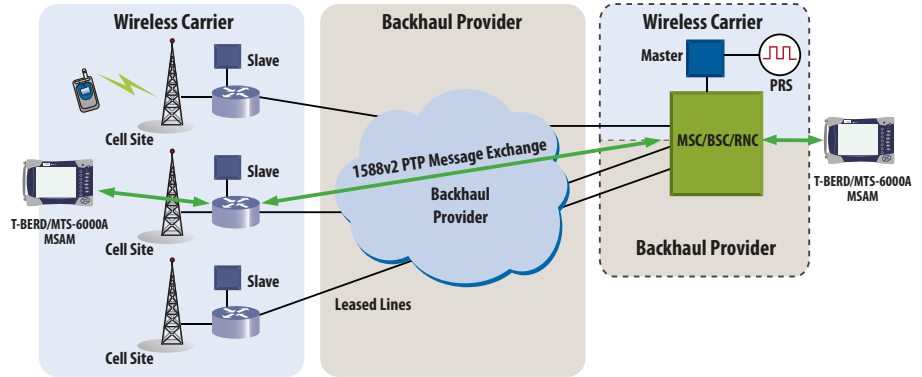

Triple-Play Service Test

The JDSU Triple-Play Service test simplifies the setup and interpretation of results for voice, video, and data services. This test also lets users emulate multiple voice calls, a real audio stream with voice playback, two video streams, and two different data streams, enabling them to quickly configure a test without having to calculate per-service stream bandwidth and characteristics. Quick configurations include the number of voice calls, the codec, and the number of standard (SDTV) and high definition television (HDTV) streams, including compression used as well as two different data streams with constant or ramp traffic patterns. QoS results, such as throughput, delay, loss, and jitter, are measured per CoS to verify that the network is properly prioritizing each service type.

Verifying CoS with Multiple Streams

Multi-Stream testing generates several streams of traffic at the Ethernet, IP, and TCP/UDP layers (Layers 2-4) to emulate various types of traffic with the appropriate CoS mappings so that users can assess the impact of traffic prioritization on the overall network architecture while confirming proper network element queuing, policing, and shaping. Up to 10 individually configured streams enable generation and analysis of per stream key parameters such as VLAN ID and priority, TOS/DSCP marking, packet size, source/destination IP and MAC address, and source/destination TCP/UDP ports. Users can configure constant or ramp traffic to simulate near real-world traffic before actually delivering a service. This level of testing confirms the network design as well as drastically reduces post-installation troubleshooting.

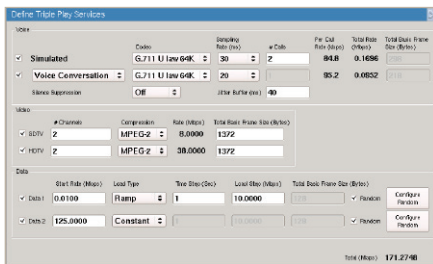

Configuring triple-play profiles

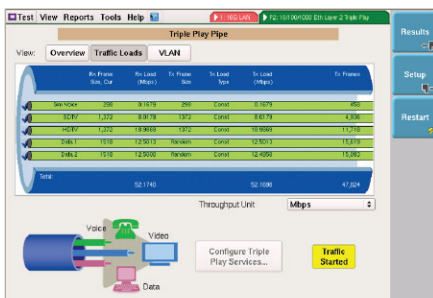

Triple-play summary network pipe screen

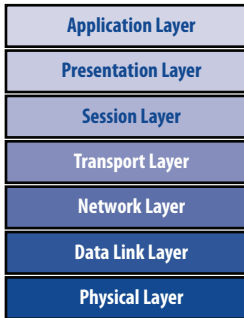

Carrier Ethernet Fault Isolation Testing

J-Profiler Traffic Explorer

J-Profiler delivers a powerful passive Ethernet monitoring application/traffic explorer intended for live, in-service links used by Metro aggregation networks. It also provides non-intrusive automatic discovery of VLAN, Q-in-Q, IP, and TCP streams as well as displays top talkers and bandwidth utilization per stream and the VLAN user priority or TOS/DSCP bits for each flow. With powerful Carrier Ethernet circuit profiling, technicians can quickly identify erroneously configured EVCs and streams that are consuming more than their fair share of bandwidth in a fraction of the time.

Additionally, the VLAN Scan tool enables technicians to quickly confirm end-to-end connectivity for ranges of VLANs by recursively sending short burst of data across the configurable VLAN ranges to confirm proper setup end to end.

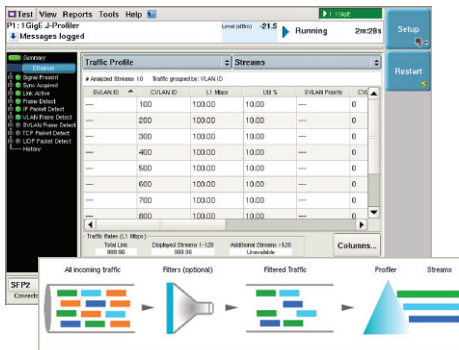

J-Profiler display of top talkers, bandwidth utilization, and TOS/DSCP bits for each flow

Packet Capture, WireShark Decode, J-Mentor Expert Analysis, and Network Discovery Troubleshooting

In the ever-changing Ethernet and IP world providers must quickly, cost-efficiently, and reliably troubleshoot problems at all layers of the stack. The MSAM provides powerful line-rate packet capture at all Ethernet speeds (10 Mbps to 10 GigE) without dropping a single packet. When troubleshooting problems occur intermittently or inconsistently, it supports multiple traffic filters and triggers, including 16-byte pattern identification, to isolate the exact problem and minimize the amount of information gathered.

The MSAM natively supports WireShark for on-instrument packet decode. Additionally, users can save captured traffic in a standard pcap file format and export it via USB for further analysis.

J-Mentor Expert Analysis provides the visibility needed to lower the costs and difficulties associated with resolving problems such as incorrect priority provisioning, misconfigured IP addresses, TCP retransmissions, unresolved ARPs, and routing issues. J-Mentor Expert enables analysis of pcap files on the MSAM. It also automatically makes recommendations to users for resolving problems discovered. Likewise, it makes available a list of top talkers to expose top bandwidth hogs.

The Network Discovery test identifies nodes and devices on the local network to gain knowledge of accessible devices prior to analysis and debug. The automatic discovery test reports devices organized by hierarchy, including IP networks, domains, VLANs, routers, switches, hosts, and servers.

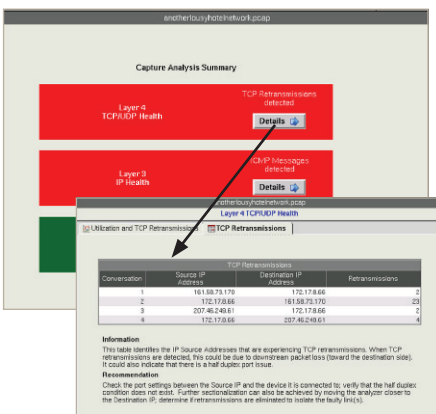

Troubleshoot with J-Mentor

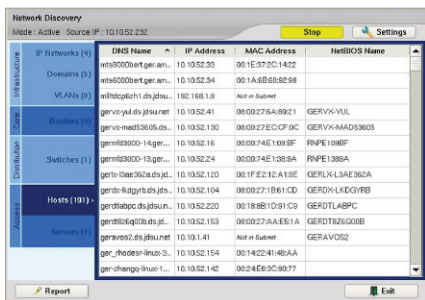

Network discovery

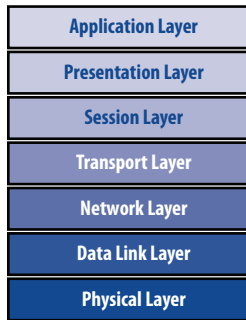

Application-Centric Ethernet/IP

One of the emerging challenges in modern Ethernet networks is how best to test the performance of higher-layer services and applications. Unlike SONET/ SDH and DSx/PDH networks where bandwidth can be reserved through Time Division Multiplexing (TDM) techniques, multi-service Ethernet/IP networks take advantage of statistical multiplexing. By using traffic priority queuing, policing, and shaping to ensure that bandwidth is available to applications when needed and not wastefully reserved even when not used, modern Ethernet/IP multi-service networks deliver a substantial cost advantage over traditional single-purpose networks. This fundamental shift in networking drives the need for application layer installation testing to improve the performance, reliability, and health of network services and applications. With hundreds of performance-affecting variables across multiple network layers, network architects, engineers, and technicians need help narrowing down the most likely cause of customer/user dissatisfaction.

Due to the nature of Ethernet/IP traffic, testing throughput only at Layer 2 (Ethernet) and Layer 3 (IP) is insufficient for ensuring optimal performance of applications and services. Over long-haul circuits, the “long fat pipe” effect causes an under-utilization of the bandwidth by keeping the TCP window size too low based on the amount of circuit latency. The automated TCP test suite based on IETF draft standard test methodology can improve TCP utilization and performance as well as file transfer times. TCP walk-the-window testing uncovers the optimal TCP window size.



Workflow for Application-Centric Turn-up

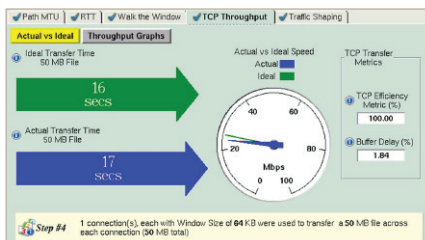

Automated TCP Test

Automated TCP, FTP, and HTTP Throughput Testing

The automated TCP TrueSpeed™ test follows industry best practices to prove that the network can provide quality TCP application performance. These proven steps include determining optimal window size parameters, measuring real download speeds, providing TCP efficiency metrics, and loading the network to expose potential policing or buffering problems. An HTTP Throughput tool reports the time required to load a user-configurable web page while the FTP Throughput tool reports the time needed to retrieve a file from a user-configurable FTP server.

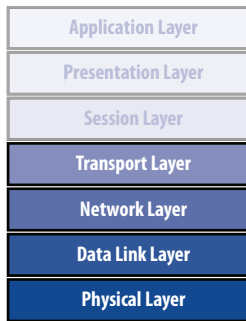

TCPWireSpeed

Utilizing new TCP WireSpeed testing capabilities, service providers can more closely emulate real-world customer traffic by configuring up to 64 concurrent TCP sessions across a stateful TCP stream in addition to having four separate background TCP streams. The stateful TCP stream is able to traverse network address translations (NATs) and firewalls to provide true end-point TCP testing. With throughput, latency, and number of retransmissions reported per stream, technicians and engineers can properly optimize and characterize the performance of the routers and firewalls by blasting TCP traffic at line rates from 10 Mbps to 10 Gbps.

Powerful IPTV and MSTV Testing

The MSAM supports comprehensive IPTV and MSTV test capabilities so technicians can verify network provisioning through video stream access at various network points and analyze QoS. This capability enables them to verify that the physical, transport, and video stream layers are free of errors and alarms. Detailed troubleshooting in selected streams verifies transport layer conditions, including packet loss, jitter, MDI, distance error, and period errors. Technicians can also verify conditions of the video stream layer, including program clock reference (PCR) jitter, sync loss errors, and continuity counter errors such as video packet loss, transport error indicators, and PID errors.

The IPTV test suite supports line rates of 10 Mbps to 10 GigE, single (SPTS) and multiple program transport stream (MPTS) formats with a video explorer capable of detecting 512 SPTS and 32 MPTS and a video analyzer that supports 16 SPTS and 1 MPTS. Analysis performed includes bandwidth utilization, packet loss, packet jitter, PCR jitter, MDI (per RFC 4445), continuity error bit and error bit indicator, and TR 101 290 priority 1 errors such as PID, program association table (PAT), and program map table (PMT). It also supports loss distance and period errors per RFC 3357, results per transport stream and per PID, and Internet Group Management Protocol (IGMP).

The MSTV test suite supports line rates of 10 Mbps to 10 GigE, including automatic detection of up to 16 multicast and unicast streams from a single set top box (STB). Comprehensive monitor analysis includes ICC latency, R-UDP latency, packet loss, and MSTV command/control message log for in-depth troubleshooting.

VoIP Call Placement and Analysis

As more TDM circuits are converted to VoIP trunks, Metro network technicians require a tool that can objectively confirm VoIP call quality at installation and can more quickly troubleshoot service problems. The VoIP Test Suite supports call placement and server/proxy registration using SIP, Cisco SCCP, and H.323 Fast Connect signaling protocols as well as a complete set of CODECs. Easy-to-understand results using green/red (pass/fail, respectively) summaries by layer (Ethernet, IP, or RTP) make it quick and easy for technicians to identify and resolve problems. Summary results can be drilled down to discover audio jitter, delay, and packet loss statistics for the IP, and Real-Time Transport Protocol (RTP) layers. MOS and R-Factor scoring present true call quality in a quantifiable and standard measurement, thus eliminating listener subjectivity. The MSAM supports capture and decode of VoIP calls and supports filtering by voice traffic or signaling to greatly enhance troubleshooting capabilities.

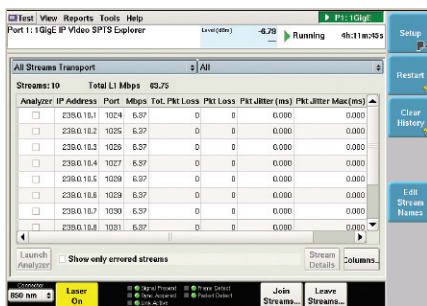

TCP Wirespeed

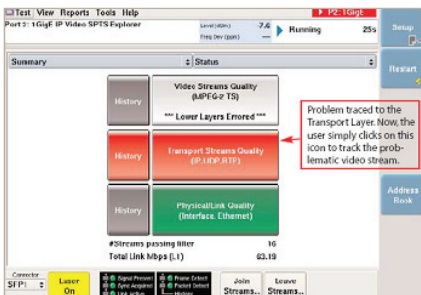

IPTV Testing

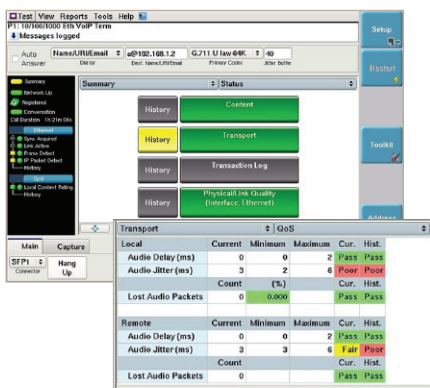

VoIP Call Placement and Analysis

Application Layer
Presentation Layer
Session Layer
Transport Layer
Network Layer
Data Link Layer
Physical Layer

Optical Transport Network (OTN)

The goal of the OTN, or digital wrapper technology, is to combine and accelerate the benefits of SONET/SDH with the bandwidth expandability of dense wavelength division multiplexing (DWDM). OTN applies the operations, administration, maintenance, and provisioning (OAM&P) functionality of SONET/SDH, which allows for protocol transparency; optimized, error-free transmission; and reduces the number of Reamplify – Reshape – Retime (3R) regeneration points in an optical network. OTN can also aggregate lower rate traffic into higher rate signals (similar to SONET/SDH), commonly referred to as optical density unit (ODU) multiplexing. This capability enables operators to cost-effectively install, maintain, and scale their next-generation networks. The figure below provides a view of the OTN frame.

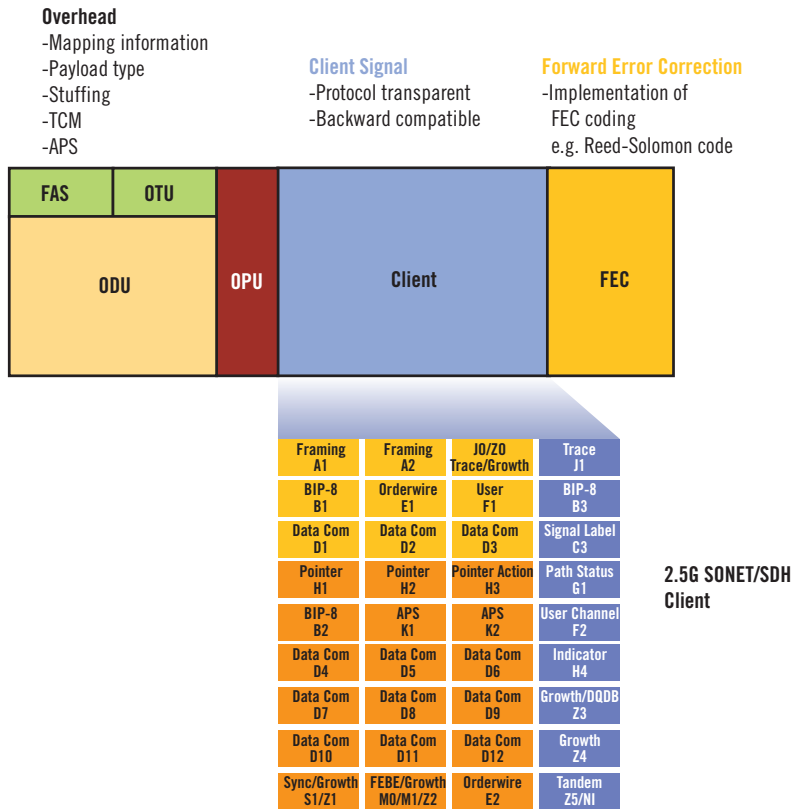

OTN Frame

Application Layer
Presentation Layer
Session Layer
Transport Layer
Network Layer
Data Link Layer
Physical Layer

Storage Area Networking

Fibre Channel/FICON Overview

The MSAM tests 1, 2, 4, and 10 Gbps Fibre Channel (FC) and fiber connection (FICON) services. Users can manipulate various fields of the FC frames to emulate end customer traffic and perform BER measurements on L1 and L2 circuits. The MSAM supports buffer crediting capability, which lets providers verify the effect of delay on the link throughput and test the ability of the link to obtain the optimum buffer credit values. The MSAM also allows users to turn up storage area networks (SANs) efficiently using the FC automated test script producing reliable throughput, packet loss, RTD, and burstability results with a consistent test methodology. The graphic below displays an example of a testing in a SAN.

'RFC-like' Fibre Channel Testing

- Adapts RFC 2544 testing methodology to FC circuits
- Allows for automated test routines and results analysis
- Allows for the saving of specific test configurations and routines

The MSAM provides an automated test routine and results analysis that can be configured to automatically verify the optimal buffer credit size to meet the desired SLAs of the link by:

1. Finding the optimal buffer size
2. Calculating the minimum buffer credit size for the specified throughput at each frame length
3. Measuring throughput at various buffer credit sizes

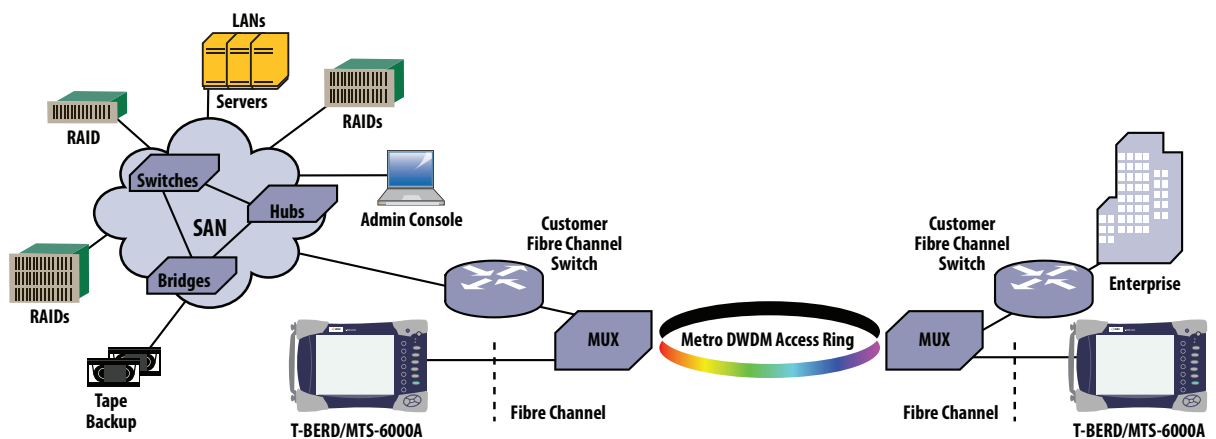

Storage Area Network

Application Layer
Presentation Layer
Session Layer
Transport Layer
Network Layer
Data Link Layer
Physical Layer

CPRI 3.1 Gbps Transport

CPRI Application Overview

Long-term evolution (LTE) and 3G/4G wireless backhaul deployments are increasingly using the Common Public Radio Interface (CPRI) protocol to implement more cost-effective distributive wireless base station architectures. Smaller, lower-cost radio heads (antennas) located at cell sites are connected via CPRI to a single radio controller located at the central office, reducing Wireless Operator OpEx/CapEx. CPRI is the communication protocol that is used to synchronize, control, and transport data between the radio controller and remote radio heads. The CPRI test application enables technicians to validate correct configuration of the transport equipment and underlying dark fiber/DWDM network to transport this protocol reliably and meet CPRI service requirements.

BER and Latency Testing

The MSAM CPRI 3.1 Gbps application supports optical Layer 1 (L1) BER testing for stress testing the underlying physical transport link. A wide array of standardized IEEE 802.3 and NCITS BERT patterns, including High Frequency Test Pattern (HFPAT) and Jitter Tolerance Test Pattern (JTPAT), enables verification of the CPRI transport links. Key QoS measurements include bit error rates, pattern sync, latency, line coding, and signal/power level.

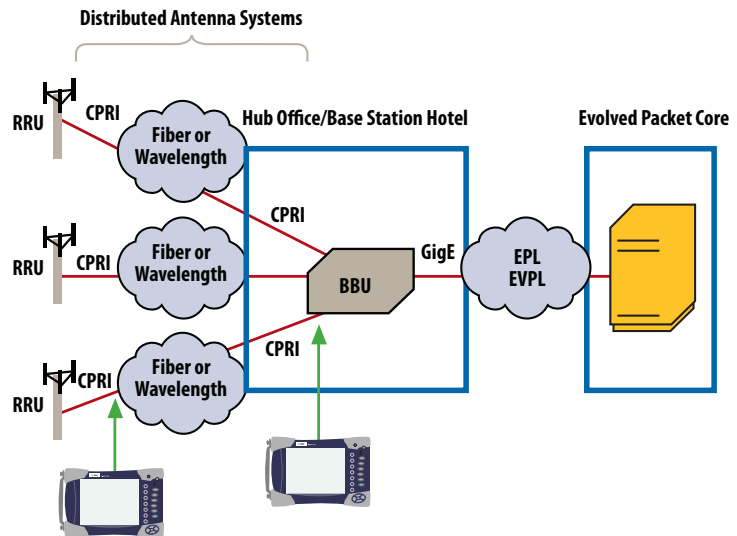

Service Disruption Measurements



SONET/SDH and PDH/T-Carrier

DS0 to 10 G SONET/SDH Testing

The MSAM performs BER testing on all line interfaces in end-to-end or loopback applications, inserts errors and alarms to verify NE conformance and connectivity, and measures BERs from DS1 (1.5M)/E1 (2.048M) rates to OC-192/STM-64. Support for ISDN PRI and T1 signaling as well as fractional (Nx56k, Nx64k) T1/E1 and VF tone generation and measurement are included from the electrical interfaces. For STM/OC interfaces, J-Scan provides automated tributary/channel scanning and alarm reporting enabling drill down into the errored tributary/channel. E4, STM1e, and STS-1e electrical interfaces are also available on the MSAM.

SONET/SDH Overhead Byte Manipulation and Analysis

Using the overhead byte manipulation and analysis capability of the MSAM, users can modify K1 and K2 bytes to test automatic protection switching (APS) to specify and identify user-configurable path trace messages and payloads. The path overhead (POH) capture feature facilitates troubleshooting end-to-end problems. The MSAM supports manual capture, capture on alarm, and capture based on user-defined triggers.

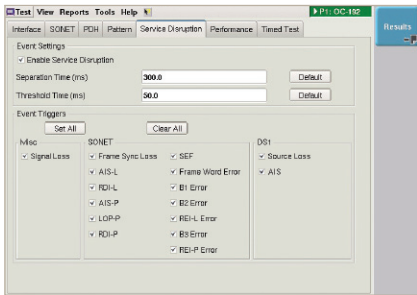

Trigger on multiple simultaneous events

Service Disruption Measurements

The MSAM measures the protection switch times of SONET/SDH rings and their effects on tributaries. Simultaneous monitoring of various error conditions on the tributaries, lets providers verify that their transport network is providing adequate redundancy to guarantee SLAs shown in the figure showing Service Disruption Measurements.

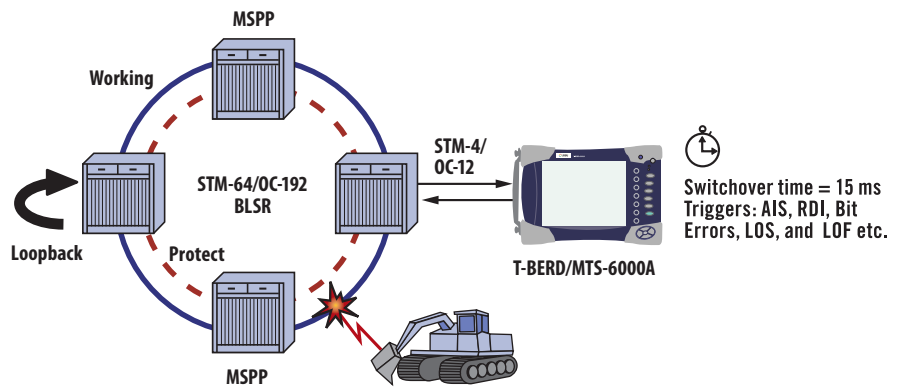

Service Disruption

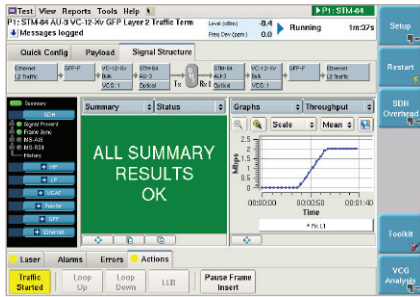

Ethernet Throughput testing inside 10G SONET/SDH link

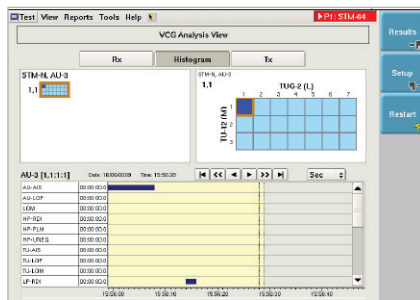

Analysis of a virtually concatenated group

Testing Ethernet and IP services transported via VCAT, GFP, and LCAS

As Ethernet services become more prominent, carriers are challenged to offer them more economically by reusing their existing SONET/SDH infrastructure. As an extension to classic SONET/SDH functionality, VCAT, GFP and LCAS offer a solution.

The MSAM offers the industry's smallest, lightest solution for testing SONET/SDH to the Ethernet layer with one module and one graphical user interface (GUI) for all SONET/SDH interfaces up to 10 G. This capability is particularly useful when troubleshooting problems in the field. The GUI guides inexperienced users directly to the layer causing trouble without an expert understanding of every layer.

Besides offering classical SONET/SDH testing capabilities (including overhead analysis, round-trip delay testing, and service disruption) the MSAM also offers full flexibility to set up and analyze VCAT structures as well as verify the correct transformation of the asynchronous Ethernet frames into the synchronous SONET/SDH containers on the GFP layer.

The MSAM provides other advanced features including GFP and SONET/SDH alarm insertion. It also fully supports LCAS including the calculation of Rx differential delay due to virtual containers and tributaries taking diverse paths through the SONET/SDH network. Additionally, LCAS capture enables deep troubleshooting of circuit problems.

For Ethernet, the MSAM can perform tests such as RFC 2544, packet jitter analysis, and ping on Layer 2 (Ethernet) and Layer 3 (IP). Alarm, error insertion, and analysis capabilities at all layers can be used to stress test the network and verify correct reporting in network management.

Specifications
General (Typical 25°C)
Display

Touchscreen, TFT color, 8.4 in LCD, 800 x 600,
high-visibility

Storage and I/O Interfaces

Internal memory 1000 test results
Extended memory Minimum 1 GB
Ports 2x USB V1.1, 1x RJ45 Ethernet

Power Supply

Battery type Standard removable Li-ion battery
AC/DC adapter Input 100–240 V, 50–60 Hz
Output 19 V DC/3.1 A
Operation time Typical operation time is 3 hours,
depending on the application

Size and Weight

Mainframe with one plug-in 285 x 195 x 93 mm
module and battery (l x h x w) (11.2 x 7.7 x 3.7 in)
Mainframe only
(without battery and module) 2.4 kg (5.3 lb)
Mainframe with one plug-in
module and battery 4 kg (9 lb)

Environmental

Operating temperature range (no options) –20 to +50°C
(–4 to 122°F)
Operating temperature range (all options) 0 to +40°C
(32 to 104°F)
Storage temperature range –20 to +60°C
(–4 to 140°F)
Humidity, non-condensing 95%

Base Unit Optical Interfaces (optional)
Power Meter

Power level +10 to –55 dBm
Calibrated wavelengths 850, 1310, and 1550 nm
Connector type Universal push/pull (UPP)

Talk Set

Wavelength 1550 nm ±20 nm
Dynamic range >45 dB range
Function With data/file transfer
Laser safety Class 1M laser
Connector type Field interchangeable

Visual Fault Locator (VFL)

Wavelength 635 nm ±15 nm
Output power level <1 mW
Laser safety Class 2 laser
Connector type Universal push/pull (UPP)

Continuous Wave (CW) Light Source

Wavelengths (selection) 1310, 1550, and 1625 nm
Output power level –3.5 dBm
Stability in 15 min ± 0.02 dB
Stability in 8 hrs ± 0.2 dB
Laser safety Class 1M laser
Connector type Field interchangeable

Video Inspection Scope (via USB)

Magnification 250X or 400X, through the USB port

Test & Measurement Regional Sales

NORTH AMERICA TEL: 1 866 228 3762 FAX: +1 301 353 9216	LATIN AMERICA TEL: +1 954 688 5660 FAX: +1 954 345 4668	ASIA PACIFIC TEL: +852 2892 0990 FAX: +852 2892 0770	EMEA TEL: +49 7121 86 2222 FAX: +49 7121 86 1222	WEBSITE: www.jdsu.com/test
---	--	---	---	--