

RIGOL

User's Guide

DS1000Z Series Digital Oscilloscope

Aug. 2013

RIGOL Technologies, Inc.

Guaranty and Declaration

Copyright

© 2013 RIGOL Technologies, Inc. All Rights Reserved.

Trademark Information

RIGOL is a registered trademark of RIGOL Technologies, Inc.

Publication Number

UGA17101-1112

Notices

- **RIGOL** products are protected by patent law in and outside of P.R.C.
- **RIGOL** reserves the right to modify or change parts of or all the specifications and pricing policies at company's sole decision.
- Information in this publication replaces all previously corresponding material.
- **RIGOL** shall not be liable for losses caused by either incidental or consequential in connection with the furnishing, use or performance of this manual as well as any information contained.
- Any part of this document is forbidden to be copied or photocopied or rearranged without prior written approval of **RIGOL**.

Product Certification

RIGOL guarantees this product conforms to the national and industrial standards in China as well as the ISO9001:2008 standard and the ISO14001:2004 standard. Other international standard conformance certification is in progress.

Contact Us

If you have any problem or requirement when using our products, please contact RIGOL Technologies, Inc. or your local distributors, or visit: www.rigol.com.

Safety Requirement

General Safety Summary

Please review the following safety precautions carefully before putting the instrument into operation so as to avoid any personal injuries or damages to the instrument and any product connected to it. To prevent potential hazards, please use the instrument only specified by this manual.

Use Proper Power Cord.

Only the power cord designed for the instrument and authorized by local country could be used.

Ground The Instrument.

The instrument is grounded through the Protective Earth lead of the power cord. To avoid electric shock, it is essential to connect the earth terminal of power cord to the Protective Earth terminal before any inputs or outputs.

Connect the Probe Correctly.

Do not connect the ground lead to high voltage since it has the isobaric electric potential as ground.

Observe All Terminal Ratings.

To avoid fire or shock hazard, observe all ratings and markers on the instrument and check your manual for more information about ratings before connecting.

Use Proper Overvoltage Protection.

Make sure that no overvoltage (such as that caused by a thunderstorm) can reach the product, or else the operator might expose to danger of electrical shock.

Do Not Operate Without Covers.

Do not operate the instrument with covers or panels removed.

Use Proper Fuse.

Please use the specified fuses.

Avoid Circuit or Wire Exposure.

Do not touch exposed junctions and components when the unit is powered.

Do Not Operate With Suspected Failures.

If you suspect damage occurs to the instrument, have it inspected by qualified service personnel before further operations. Any maintenance, adjustment or replacement especially to circuits or accessories must be performed by **RIGOL** authorized personnel.

Keep Well Ventilation.

Inadequate ventilation may cause increasing of temperature or damages to the device. So please keep well ventilated and inspect the intake and fan regularly.

Do Not Operate in Wet Conditions.

In order to avoid short circuiting to the interior of the device or electric shock, please do not operate in a humid environment.

Do Not Operate in an Explosive Atmosphere.

In order to avoid damages to the device or personal injuries, it is important to operate the device away from an explosive atmosphere.

Keep Product Surfaces Clean and Dry.

To avoid the influence of dust and/or moisture in air, please keep the surface of device clean and dry.

Electrostatic Prevention.

Operate in an electrostatic discharge protective area environment to avoid damages induced by static discharges. Always ground both the internal and external conductors of the cable to release static before connecting.

Handling Safety.

Please handle with care during transportation to avoid damages to buttons, knob interfaces and other parts on the panels.

Safety Terms and Symbols

Terms in this Manual. These terms may appear in this manual:



WARNING

Warning statements indicate the conditions or practices that could result in injury or loss of life.



CAUTION

Caution statements indicate the conditions or practices that could result in damage to this product or other property.

Terms on the Product. These terms may appear on the Product:

DANGER indicates an injury or hazard may immediately happen.

WARNING indicates an injury or hazard may be accessible potentially.

CAUTION indicates a potential damage to the instrument or other property might occur.

Symbols on the Product. These symbols may appear on the product:



**Hazardous
Voltage**



**Safety
Warning**



**Protective
Earth
Terminal**



**Chassis
Ground**



**Test
Ground**

Measurement Category

Measurement Category

DS1000Z series digital oscilloscopes can make measurements in Measurement Category I.



WARNING

This oscilloscope can only be used for measurements within its specified measurement categories.

Measurement Category Definitions

Measurement category I is for measurements performed on circuits not directly connected to MAINS. Examples are measurements on circuits not derived from MAINS, and specially protected (internal) MAINS derived circuits. In the latter case, transient stresses are variable; for that reason, the transient withstand capability of the equipment is made known to the user.

Measurement category II is for measurements performed on circuits directly connected to the low voltage installation. Examples are measurements on household appliances, portable tools and similar equipment.

Measurement category III is for measurements performed in the building installation. Examples are measurements on distribution boards, circuit-breakers, wiring, including cables, bus-bars, junction boxes, switches, socket-outlets in the fixed installation, and equipment for industrial use and some other equipment, for example. Stationary motors with permanent connection to the fixed installation.

Measurement category IV is for measurements performed at the source of the low-voltage installation. Examples are electricity meters and measurements on primary overcurrent protection devices and ripple control units.

Ventilation Requirement

This oscilloscope uses fan to force cooling. Please make sure that the air intake and exhaust areas are free from obstructions and have free air. When using the oscilloscope in a bench-top or rack setting, provide at least 10 cm clearance beside, above and behind the instrument for adequate ventilation.



WARNING

Inadequate ventilation may cause temperature increase which would damage the instrument. So please keep the instrument well ventilated during operation and inspect the intake and fan regularly.

Working Environment

Temperature

Operating: 0°C to +50°C

Non-operating: -40°C to +70°C

Humidity

0°C to +30°C: ≤95% relative humidity

+30°C to +40°C: ≤75% relative humidity

+40°C to +50°C: ≤45% relative humidity



WARNING

To avoid short circuit inside the instrument or electric shock, please do not operate in humid environment.

Altitude

Operating: less than 3 km

Non-operating: less than 15 km

Installation (overvoltage) Category

This product is powered by mains conforming to installation (overvoltage) category II.



WARNING

Make sure that no overvoltage (such as that caused by thunderbolt) can reach the product, or else the operator might expose to danger of electric shock.

Installation (overvoltage) Category Definitions

Installation (overvoltage) category I refers to signal level which is applicable to equipment measurement terminals connected to the source circuit. In these terminals, precautions are done to limit the transient voltage to the corresponding low level.

Installation (overvoltage) category II refers to the local power distribution level which is applicable to equipment connected to the AC line (AC power).

Pollution Degree

Degree 2

Pollution Degree Definitions

Pollution degree 1: No pollution or only dry, non-conductive pollution occurs. The pollution has no influence. For example: a clean room or air-conditioned office environment.

Pollution degree 2: Normally only dry, non-conductive pollution occurs. Occasionally a temporary conductivity caused by condensation may occur. For example: general indoor environment.

Pollution degree 3: Conductive pollution occurs, or dry, non-conductive pollution occurs which becomes conductive due to condensation which is expected. For example: Sheltered outdoor environment.

Pollution degree 4: Pollution that generates persistent conductivity through conductive dust, rain, or snow. For example: outdoor locations.

Safety Class

Class 1 – Grounded Product

General Care and Cleaning

General Care:

Do not store or leave the instrument at places where the instrument will be exposed to direct sunlight for long periods of time.

Cleaning:

Clean the instrument regularly according to its operating conditions. To clean the exterior surface:

1. Disconnect the instrument from all power sources.
2. Clean the loose dust on the outside of the instrument with a lint-free cloth (with mild detergent or water). When cleaning the LCD, take care to avoid scarifying it.



CAUTION

To avoid damages to the instrument, do not expose them to corrosive liquids.



WARNING

To avoid injury resulting from short circuit, make sure the instrument is completely dry before reconnecting it to a power source.

Environmental Considerations

The following symbol indicates that this product complies with the applicable European Union requirements according to Directives 2002/96/EC on waste electrical and electronic equipment (WEEE).



Product End-of-Life Handling

The equipment may contain substances that could be harmful to the environment or human health. In order to avoid release of such substances into the environment and harm to human health, we encourage you to recycle this product in an appropriate system that will ensure that most of the materials are reused or recycled appropriately. Please contact your local authorities for disposal or recycling information.

DS1000Z Series Overview

DS1000Z is a high-performance digital oscilloscope developed on the basis of the UltraVision technique. DS1000Z, featuring rather deep memory depth, ultra-wide dynamic range, superb waveform capture rate and all-round trigger functions, is an invaluable debug instrument in various fields (such as communication, cosmonautics, national defense, embedded system, computer, research and education) and is the one with the most complete functions and most outstanding specification among the digital oscilloscopes with lower than 100 MHz bandwidth.

Main features:

- 100 MHz and 70 MHz bandwidth.
- UltraVision technique.
- 1 GSa/s maximum real-time sample rate.
- 30,000 wfms/s (dots display) waveform capture rate.
- Real-time hardware waveform recording, waveform playback functions. Up to 60,000 frames of waveform can be recorded.
- 24 Mpts maximum memory depth (option) and 12 Mpts standard memory depth.
- Multi-degree gray scale display.
- Low noise, 1 mV/div to 10 V/div ultra-wide vertical dynamic range.
- 7.0 inches, WVGA (800*480) 160,000 color TFT LCD, vivid picture, low power consumption and long service life.
- Adjustable brightness of analog channel waveform.
- Auto setting of waveform display (**AUTO**).
- 15 kinds of trigger functions including multiple protocol triggers.
- Standard parallel decoding and multiple serial decoding options.
- Auto measurements of 24 waveform parameters and measurement functions with statistic.
- Precise delayed sweep function.
- Built-in FFT function.
- Pass/Fail test function.
- Multiple waveform math operation functions.
- Built-in dual-channel, 25 MHz signal source function (only available for DS1000Z-S).
- Standard configuration interfaces: USB Device, USB Host, LAN and GPIB (optional).
- Conform to LXI-C instrument standards. Enable quick, economic and efficient

creation and reconfiguration of test system.

- Support remote command control.
- Embedded help enables easier information access.
- Support multiple languages and Chinese/English input.
- Novel and delicate industrial design and easier operation.

Document Overview

[Chapter 1 Quick Start](#)

Provide information about preparations before using the instrument and a brief introduction of the instrument.

[Chapter 2 To Set the Vertical System](#)

Introduce the functions of the vertical system of the oscilloscope.

[Chapter 3 To Set the Horizontal System](#)

Introduce the functions of the horizontal system of the oscilloscope.

[Chapter 4 To Set the Sample System](#)

Introduce the functions of the sample system of the oscilloscope.

[Chapter 5 To Trigger the Oscilloscope](#)

Introduce the trigger mode, trigger coupling, trigger holdoff, external trigger and various trigger types of the oscilloscope.

[Chapter 6 To Make Measurements](#)

Introduce how to make math operation, cursor measurement and auto measurement.

[Chapter 7 Protocol Decoding](#)

Introduce how to decode the input signal using those common protocols.

[Chapter 8 Reference Waveform](#)

Introduce how to compare the input waveform with the reference waveform.

[Chapter 9 Pass/Fail Test](#)

Introduce how to monitor the input signal using the Pass/Fail test.

[Chapter 10 Waveform Record](#)

Introduce how to analyze the input signal using waveform record.

[Chapter 11 Display Control](#)

Introduce how to control the display of the oscilloscope.

[Chapter 12 Signal Source](#)

Introduce how to use the built-in signal source.

[Chapter 13 Store and Recall](#)

Introduce how to store and recall the measurement result and the setting of the oscilloscope.

[Chapter 14 System Function Setting](#)

Introduce how to set the remote interface and system-related functions.

[Chapter 15 Remote Control](#)

Introduce how to control the oscilloscope remotely.

[Chapter 16 Troubleshooting](#)

Introduce how to deal with common failures of the oscilloscope.

[Chapter 17 Specifications](#)

Provide the specifications and general specifications of the oscilloscope.

[Chapter 18 Appendix](#)

Provide common information such as options and accessories.

Format Conventions in this Manual:







Front panel key: denoted by the format of "Text Box + Button Name (Bold)", for example, **Storage**.

Menu softkey: denoted by the format of "Character Shading + Menu Word (Bold)", for example, **Storage**.

Operation steps: denoted by the arrow "→", for example, **Storage** → **Storage**.

Cross-reference: denoted by the blue font with bold and underline, for example, **[12 Signal Source](#)**.

Knob:

Logo	Knob	Logo	Knob
	Multi-function Knob	VERTICAL  SCALE	Vertical Scale Knob
HORIZONTAL  SCALE	Horizontal Scale Knob	VERTICAL  POSITION	Vertical Position Knob
HORIZONTAL  POSITION	Horizontal Position Knob	TRIGGER  LEVEL	Trigger Level Knob

Content Conventions in this Manual:

This manual takes DS1104Z-S for example and the descriptions here have contained all the functions and performances of other models. DS1000Z series includes the following models:

Model	Analog bandwidth	Channels	Channels for signal source
DS1104Z	100 MHz	4	—
DS1074Z	70 MHz	4	—
DS1104Z-S	100 MHz	4	2
DS1074Z-S	70 MHz	4	2

Contents

Guaranty and Declaration	I
Safety Requirement	II
General Safety Summary.....	II
Safety Terms and Symbols	IV
Measurement Category.....	V
Ventilation Requirement.....	VI
Working Environment	VII
General Care and Cleaning.....	IX
Environmental Considerations.....	X
DS1000Z Series Overview	XI
Document Overview	XIII
Chapter 1 1 Quick Start	1-1
General Inspection	1-2
Appearance and Dimensions	1-3
To Prepare the Oscilloscope for Use	1-4
To Adjust the Supporting Legs	1-4
To Connect to Power Supply	1-5
Power-on Inspection	1-6
To Connect the Probe.....	1-7
Function Inspection	1-8
Probe Compensation.....	1-10
Front Panel Overview	1-11
Rear Panel Overview	1-12
Front Panel Function Overview	1-14
VERTICAL.....	1-14
HORIZONTAL	1-15
TRIGGER	1-15
CLEAR	1-16
RUN/STOP	1-16
SINGLE.....	1-16
AUTO	1-16
Knob	1-17

Print	1-18
User Interface	1-19
To Use the Security Lock	1-23
To Use the Built-in Help System	1-24
Chapter 2 2 To Set the Vertical System	2-1
To Enable the Channel	2-2
Channel Coupling	2-3
Bandwidth Limit	2-3
Probe Ratio	2-4
Waveform Invert	2-5
Vertical Scale	2-5
Vertical Expansion	2-6
Amplitude Unit	2-6
Channel Label	2-7
Chapter 3 3 To Set the Horizontal System	3-1
Delayed Sweep	3-2
Time Base Mode	3-4
YT Mode	3-4
XY Mode	3-5
Roll Mode	3-8
Chapter 4 4 To Set the Sample System	4-1
Acquisition Mode	4-2
Normal	4-2
Average	4-2
Peak Detect	4-4
High Resolution	4-4
Sin(x)/x	4-4
Sample Rate	4-5
Memory Depth	4-7
Chapter 5 5 To Trigger the Oscilloscope	5-1
Trigger Source	5-2
Trigger Mode	5-3
Trigger Coupling	5-5
Trigger Holdoff	5-6
Noise Rejection	5-7

Trigger Type	5-8
Edge Trigger	5-9
Pulse Trigger	5-10
Slope Trigger	5-12
Video Trigger	5-15
Pattern Trigger	5-17
Duration Trigger	5-19
Setup/Hold Trigger	5-21
TimeOut Trigger (Option)	5-23
Runt Trigger (Option)	5-25
Windows Trigger (Option)	5-28
Delay Trigger (Option)	5-30
Nth Edge Trigger (Option)	5-32
RS232 Trigger (Option)	5-34
I2C Trigger (Option)	5-36
SPI Trigger (Option)	5-39
Trigger Output Connector	5-41
Chapter 6 6 To Make Measurements	6-1
Math Operation	6-2
Addition	6-2
Substraction	6-3
Multiplication	6-3
Division	6-4
FFT	6-6
"AND" Operation	6-9
"OR" Operation	6-10
"XOR" Operation	6-11
"NOT" Operation	6-12
Integrate	6-13
Differentiate	6-13
Square Root	6-14
Base 10 Logarithm	6-15
Natural Logarithm	6-15
Exponential	6-16
Absolute Value	6-17
Auto Measurement	6-18
Quick Measurement after AUTO	6-18

One-key Measurement of 24 Parameters	6-19
Frequency Counter Measurement	6-24
Measurement Setting	6-25
To Clear the Measurement	6-26
All Measurement	6-27
Statistic Function	6-28
Cursor Measurement.....	6-29
Manual Mode.....	6-30
Track Mode	6-33
Auto Mode	6-35
Chapter 7 7 Protocol Decoding	7-1
Parallel Decoding.....	7-2
RS232 Decoding (Option).....	7-5
I2C Decoding (Option)	7-11
SPI Decoding (Option)	7-15
Chapter 8 8 Reference Waveform.....	8-1
To Enable REF Function.....	8-2
To Select REF Source	8-2
To Adjust REF Waveform Display.....	8-3
To Save to Internal Memory	8-3
To Set the Color	8-3
To reset the REF waveform.....	8-3
To Export to Internal or External Memory	8-4
To Import from Internal or External Memory	8-4
Chapter 9 9 Pass/Fail Test.....	9-1
To Enable Pass/Fail Test	9-2
To Select Source.....	9-2
Mask Range.....	9-2
Test and Ouput	9-3
To Save the Test Mask	9-4
To Load the Test Mask	9-4
Chapter 10 10 Waveform Record	10-1
Playback Setting.....	10-2
Record Setting	10-3
Chapter 11 11 Display Control.....	11-1

- To Select the Display Type 11-2
- To Set the Persistence Time 11-3
- To Set the Waveform Intensity 11-5
- To Set the Screen Grid..... 11-5
- To Set the Grid Brightness..... 11-5
- To Set the Menu Display 11-5

- Chapter 12 12 Signal Source..... 12-1**
- To Output Basic Waveform 12-2
- To Output Sine Waveform..... 12-2
- To Output Square Waveform..... 12-4
- To Output Ramp Waveform..... 12-4
- To Output Pulse Waveform 12-5
- To Output DC Waveform..... 12-5
- To Output Noise Waveform 12-6
- To Output Built-In Waveform..... 12-7
- To Output Arbitrary Waveform..... 12-12
- To Select Waveform 12-14
- To Create Waveforms 12-14
- To Edit Waveforms..... 12-17
- Modulation 12-19

- Chapter 13 13 Store and Recall 13-1**
- Storage System..... 13-2
- Storage Type 13-3
- Internal Storage and Recall 13-5
- External Storage and Recall..... 13-6
- Disk Management 13-7
- To Select File Type..... 13-8
- To Create a New File or Folder 13-9
- To Delete a File or Folder..... 13-12
- To Rename a File or Folder 13-13
- To Clear the Local Memory 13-13
- Factory..... 13-14

- Chapter 14 14 System Function Setting..... 14-1**
- Remote Interface Configuration..... 14-2
- LAN Setting..... 14-2
- USB Device 14-6

System-related.....	14-7
Sound.....	14-7
Language.....	14-7
System Information.....	14-8
Power-on Recall.....	14-8
Self-calibration.....	14-9
Option Management.....	14-10
Chapter 15 15 Remote Control	15-1
Remote Control via USB.....	15-2
Remote Control via LAN.....	15-6
Chapter 16 16 Troubleshooting	16-1
Chapter 17 17 Specifications	17-1
Chapter 18 18 Appendix	18-1
Appendix A: Accessories and Options.....	18-1
Appendix B: Warranty.....	18-2
Appendix C: Any Question or Comment?.....	18-3
Chapter 19 Index	1

Chapter 1 Quick Start

This chapter introduces the preparations when using the oscilloscope for the first time, the front panel, rear panel and user interface of the oscilloscope as well as the using method of the built-in help system.

The contents of this chapter:

- [General Inspection](#)
- [Appearance and Dimensions](#)
- [To Prepare the Oscilloscope for Use](#)
- [Front Panel Overview](#)
- [Rear Panel Overview](#)
- [Front Panel Function Overview](#)
- [User Interface](#)
- [To Use the Security Lock](#)
- [To Use the Built-in Help System](#)

General Inspection

1. **Inspect the shipping container for damage.**

Keep the damaged shipping container or cushioning material until the contents of the shipment have been checked for completeness and the instrument has passed both electrical and mechanical tests.

The consigner or carrier shall be liable for the damage to instrument resulting from shipment. **RIGOL** would not be responsible for free maintenance/rework or replacement of the unit.

2. **Inspect the instrument.**

In case of any damage, or defect, or failure, notify your **RIGOL** sales representative.

3. **Check the Accessories**

Please check the accessories according to the packing lists. If the accessories are incomplete or damaged, please contact your **RIGOL** sales representative.

Appearance and Dimensions

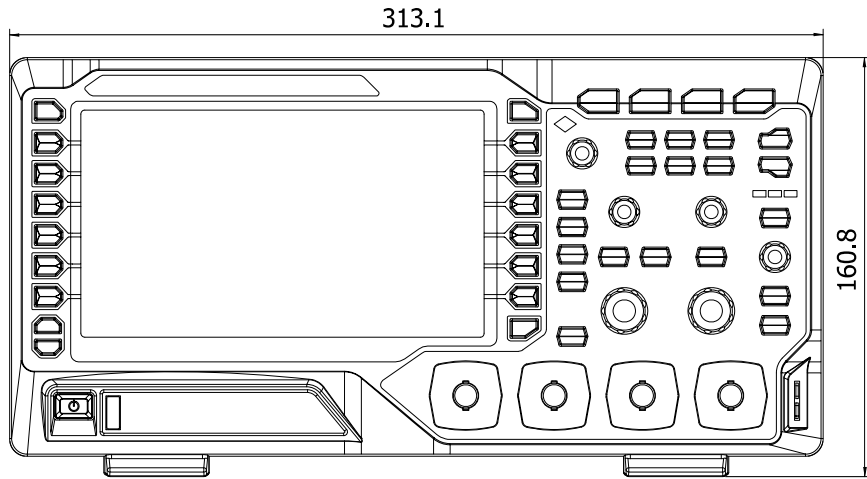

Figure 0-1 Front View

Unit: mm

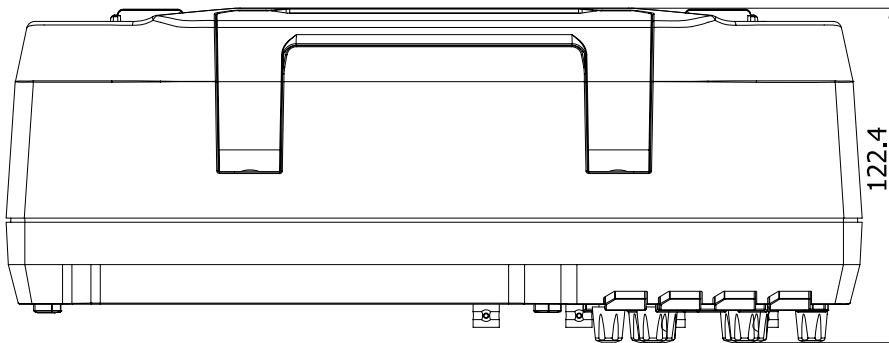

Figure 0-2 Top View

Unit: mm

To Prepare the Oscilloscope for Use

To Adjust the Supporting Legs

Adjust the supporting legs properly to use them as stands to tilt the oscilloscope upwards for stable placement of the oscilloscope as well as better operation and observation.

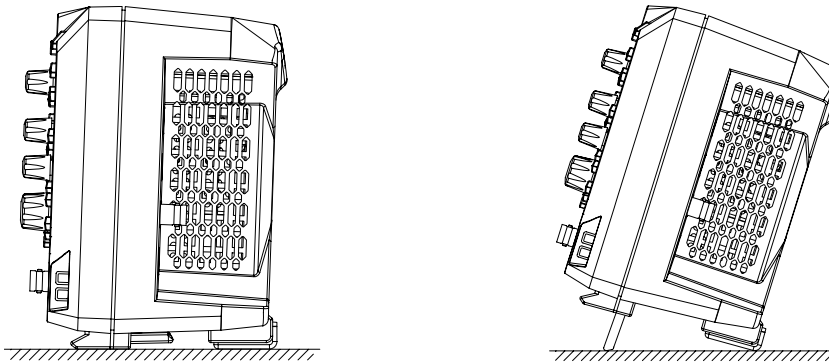

Figure 0-3 To Adjust the Supporting Legs

To Connect to Power Supply

The power requirements of DS1000Z are 100-240 V, 45-440 Hz. Please use the power cord supplied with the accessories to connect the oscilloscope to the power source.

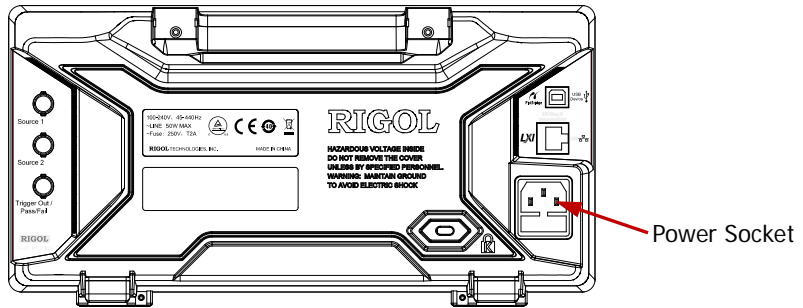



Figure 0-4 To Connect to Power Source

Power-on Inspection

When the oscilloscope is energized, press the power key  at the lower-left corner of the front panel to start the oscilloscope. During the start-up process, the oscilloscope performs a series of self-tests and after the self-test is finished, the welcome screen is displayed and you can view the Option Type, Option name, Option Edition and Left time of the option currently installed in the "Installed Options" pop-up dialog box on the screen. When the instrument is shipped, a trial version of the option is provided and the left time is about 2000 minutes.

To Connect the Probe

RIGOL provides passive probes for the DS1000Z series oscilloscopes. For detailed technical information of the probes, please refer to the corresponding Probe User's Guide. The following are the probes recommended for this oscilloscope.

Model	Description
RP3300	350 MHz, passive probe, standard
RP3500A	500 MHz, passive probe, optional

Connect the Probe:

1. Connect the BNC terminal of the probe to a channel BNC connector of the oscilloscope at the front panel.
2. First connect the ground alligator clip of the probe to the circuit ground terminal and then connect the probe tip to the circuit point to be tested.

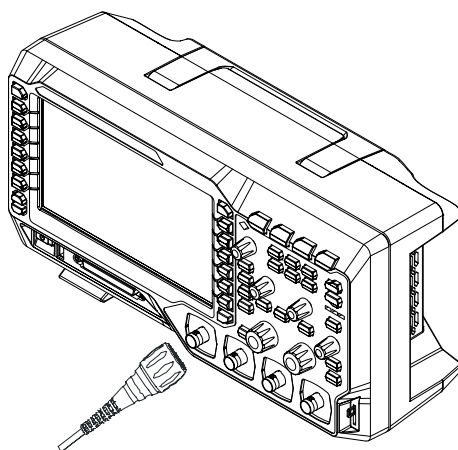

Figure 0-5 To Connect the Probe

Function Inspection

1. Press **Storage** → **Default** to restore the instrument to its default configuration.
2. Connect the ground alligator clip of the probe to the “Ground Terminal” under the probe compensation signal output terminal.
3. Use the probe to connect the input terminal of CH1 of the oscilloscope and the “Compensation Signal Output Terminal” of the probe.

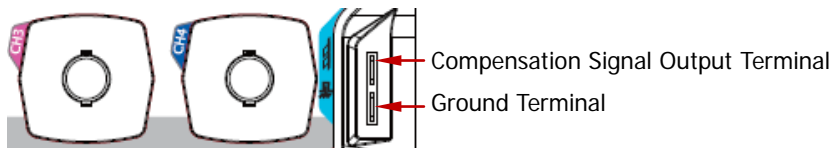

Figure 0-6 To Use the Compensation Signal

4. Press **AUTO**.
5. Observe the waveform on the display. In normal condition, the display should be a square waveform as shown in the figure below:

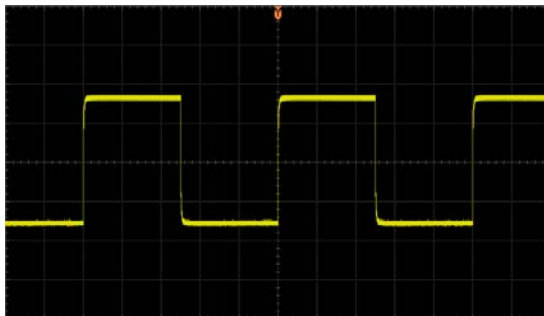

Figure 0-7 Square Waveform

6. Use the same method to test the other channels. If the square waveforms actually shown do not match that in the figure above, please perform “[Probe Compensation](#)” in the next section.



WARNING

To avoid electric shock during the use of probe, please make sure that the insulated wire of the probe is in good condition and do not touch the metallic part of the probe when the probe is connected to high voltage source.

Tip

The signal output from the probe compensation connector can only be used for probe compensation adjustment and can not be used for calibration.

Probe Compensation

When the probes are used for the first time, you should compensate the probes to match the input channels of the oscilloscope. Non-compensated or poorly compensated probes may cause measurement inaccuracy or error. The probe compensation procedures are as follows.

1. Perform steps 1, 2, 3 and 4 of "[Function Inspection](#)" in the previous section.
2. Check the waveforms displayed and compare them with the following.

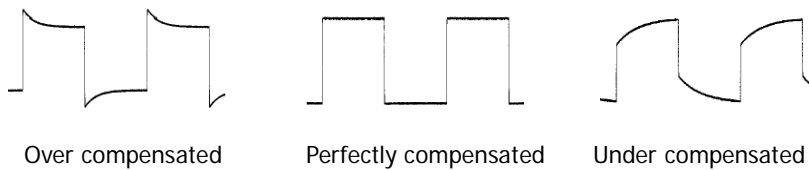

Figure 0-8 Probe Compensation

3. Use a nonmetallic driver to adjust the low-frequency compensation adjustment hole on the probe until the waveform displayed is as the "Perfectly compensated" in the figure above.

Front Panel Overview

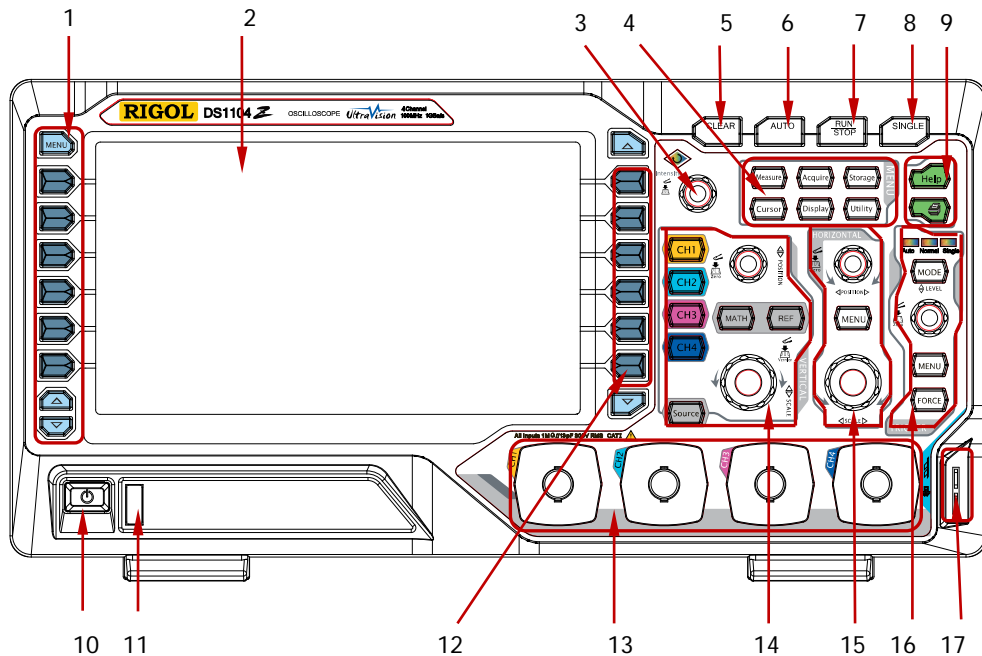

Figure 0-9 Front Panel Overview

Table 0-1 Front Panel Description

No.	Description	No.	Description
1	Menu	10	Power Key
2	LCD	11	USB HOST
3	Multi-function Knob	12	Function Setting Menu Softkeys
4	Function Menu Keys	13	Analog Channel Input Area
5	CLEAR	14	VERTICAL
6	AUTO	15	HORIZONTAL
7	RUN/STOP	16	TRIGGER
8	SINGLE	17	Probe Compensation Signal Output Terminal/Ground Terminal
9	Help&Print	--	--

Rear Panel Overview

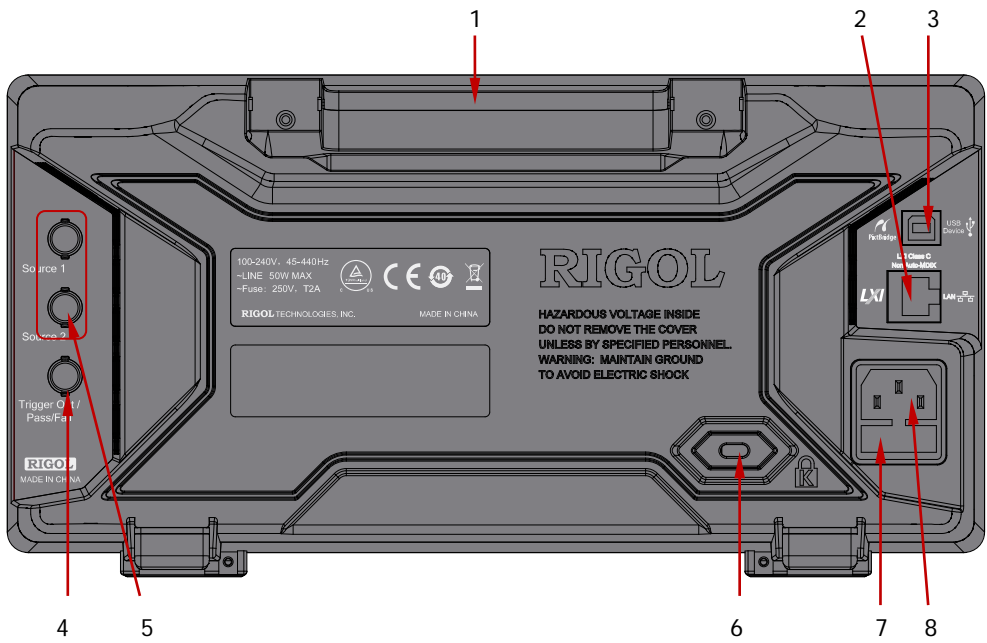

Figure 0-10 Rear Panel Overview

1. Handle

Pull up the handle vertically for easy carrying of the instrument. When you do not need the handle, press it down.

2. LAN

Connect the instrument to the network via this interface for remote control. This oscilloscope conforms to the LXI-C class instrument standards and can quickly build test system with other instruments.

3. USB DEVICE

PictBridge printer or PC can be connected via this interface to print waveform data or control the instrument using PC software or user-defined programming.

4. Trigger Out/Pass/Fail

Trigger Out: the oscilloscope outputs a signal that can reflect the current capture rate of the oscilloscope at each trigger via this connector and connect the signal to a waveform display instrument to measure the frequency of the

signal and the result is equal to the current capture rate.

Pass/Fail: there will be output a negative pulse signal when failed waveforms are detected by the oscilloscope. Connect this signal to other control systems to view the test result conveniently. There will be output a 3.3 V CMOS high level when no failed waveform is detected by the oscilloscope.

5. Signal Output

When the output of Source1 and Source2 are enabled, the signal currently set can be output to the analog input terminal of the oscilloscope or external devices connected to them through the **[Source1]** and **[Source2]** connectors at the rear panel.

6. Lock Hole

You can lock the instrument to a fixed location using the security lock (please buy it yourself) via the lock hole.

7. Fuse

If a new fuse is required, please use the specified fuse (250V, T2A).

- a) Turn off the instrument and remove the power cord.
- b) Insert a straight screwdriver into the slot at the power socket and prize out the fuse seat gently.
- c) Take out the fuse and replace it with specified fuse, and then install the fuse seat to the original position.

8. AC Power Socket

AC power input terminal. The power requirements of this oscilloscope are 100-240 V, 45-440 Hz. Use the power cord provided with the accessories to connect the instrument to AC power. Then, you can press the power key at the front panel to start the instrument.

Front Panel Function Overview

VERTICAL

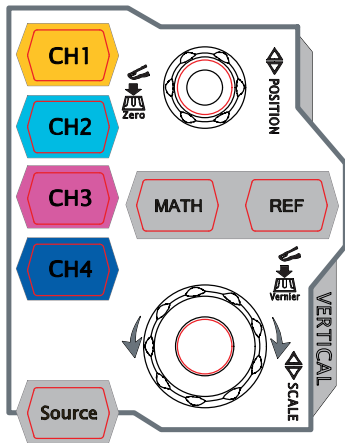

CH1, **CH2**, **CH3**, **CH4**: analog input channels. The 4 channels are marked by different colors which are also used to mark both the corresponding waveforms on the screen and the channel input connectors. Press any key to open the corresponding channel menu and press again to turn off the channel.

MATH: press this key to open the math operation menu under which add, subtract, multiply, divide, FFT, A&&B, A||B, A^B, !A, intg, diff, sqrt, lg, ln, exp and abs are provided.

REF: press this key to enable the reference waveform function to compare the waveform actually tested with the reference waveform.

Source: press this key to enter the source setting interface. You can turn on or off the outputs of the **[Source1]** and **[Source2]** connectors at the rear panel, edit the output signal and view the current signal status (such as the frequency, amplitude and phase).

Vertical **POSITION**: modify the vertical position of the current channel waveform. Turn clockwise to increase the position and turn counterclockwise to decrease. During the modification, the waveform would move up and down and the position message (e.g. **POS: 216.0mV**) at the lower-left corner of the screen would change accordingly. Press down this knob to quickly reset the vertical position to zero.

VERTICAL **SCALE**: modify the vertical scale of the current channel. Turn clockwise to decrease the scale and turn counterclockwise to increase. During the modification, the amplitude of the waveform would enlarge or reduce and the scale information (e.g. **1 = 200mV**) at the lower side of the screen would change accordingly. Press down this knob to quickly switch the vertical scale adjustment modes between "Coarse" and "Fine".

HORIZONTAL

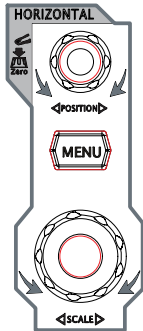

HORIZONTAL  POSITION: modify the horizontal position.

The trigger point would move left or right relative to the center of the screen when you turn the knob. During the modification, waveforms of all the channels would move left or right and the horizontal position message (e.g. **D** -200.000000ns) at the upper-right corner of the screen would change accordingly. Press down this knob to quickly reset the horizontal position (or the delayed sweep position).

MENU: press this key to open the horizontal control menu under which to turn on or off the delayed sweep function, switch between different time base modes.

HORIZONTAL  SCALE: modify the horizontal time base. Turn clockwise to reduce the time base and turn counterclockwise to increase the time base. During the modification, waveforms of all the channels will be displayed in expanded or compressed mode and the time base message (e.g. **H** 500ns) at the upper side of the screen would change accordingly. Press down this knob to quickly switch to delayed sweep state.

TRIGGER

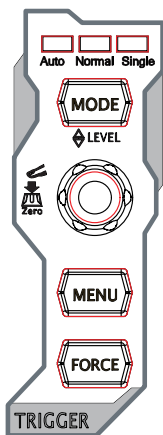

MODE: press this key to switch the trigger mode to **Auto**, **Normal** or **Single** and the corresponding state backlight of the current trigger mode would be illuminated.

TRIGGER  LEVEL: modify the trigger level. Turn clockwise to increase the level and turn counterclockwise to reduce the level. During the modification, the trigger level line would move up and down and the value in the trigger level message box (e.g. **Trig Level : 428mV**) at the lower-left corner of the screen would change accordingly. Press down the knob to quickly reset the trigger level to zero point.

MENU: press this key to open the trigger operation menu. This oscilloscope provides various trigger types.

FORCE: press this key to generate a trigger signal forcefully.

CLEAR



Press this key to clear all the waveforms on the screen. If the oscilloscope is in "RUN" state, new waveforms will still be displayed.

RUN/STOP



Press this key to set the state of the oscilloscope to "RUN" or "STOP".

In "RUN" state, the key is illuminated in yellow.

In "STOP" state, the key is illuminated in red.

SINGLE

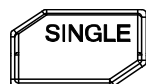

Press this key to set the trigger mode to "Single". In single trigger mode, press **FORCE** to generate a trigger signal immediately.

AUTO



Press this key to enable the waveform auto setting function. The oscilloscope will automatically adjust the vertical scale, horizontal time base and trigger mode according to the input signal to realize optimum waveform display. Note that auto setting requires that the frequency of the signal under test should be no lower than 50 Hz, the duty cycle be greater than 1% and the amplitude be at least 20

mVpp. If the parameters exceed these limits, “can’t detect any signal! ” would be displayed after pressing this key and the quick parameter measurement menu might not be displayed.

Knob



Adjust waveform brightness:

In non-menu-operation mode , turn this knob to adjust the brightness of waveform display. The adjustable range is from 0% to 100%. Turn clockwise to increase the brightness and counterclockwise to reduce. Press down this knob to reset the brightness to 50%.

You can also press **Display** → **Intensity** and use the knob to adjust the waveform brightness.

Multifunction Knob (the backlight goes on during operation):

In menu operation, press any menu softkey and turn the knob to switch the desired submenu under this menu and then press down the knob to select the current submenu. It can also be used to modify parameters and input filename. In addition, for DS1000Z-S models oscilloscope, in the source interface, press the corresponding menu softkey and then press the knob; the numeric keyboard will pop-up on the screen and you can input the desired parameter value and unit directly using this knob.

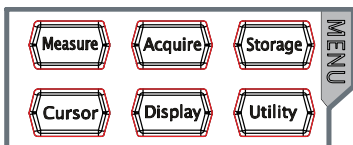

Measure: press this key to open the measurement setting menu. You can set the measurement setting, all measure, statistic function etc.

Press **MENU** at the left of the screen to switch the measurement menus of 24 waveform parameters. Then, press down the corresponding menu softkey to quickly realize one-key measurement and the measurement result will be displayed at the

bottom of the screen.

Acquire: press this key to enter the sample setting menu to set the acquisition mode, $\sin(x)/x$ and memory depth of the oscilloscope.

Storage: press this key to enter file store and recall interface. The storable file types include picture, traces, waveforms, setups, CSV and parameter. Internal and external storage as well as disk management are also supported.

Cursor: press this key to enter cursor measurement menu. The oscilloscope provides three cursor modes: manual, track and auto.

Display: press this key to enter display setting menu to set the display type, persistence time, wave intensity, grid type, grid brightness and menu display time of the waveform.

Utility: press this key to enter the system function setting menu to set the system-related functions or parameters, such as I/O setting, sound and language. Besides, some advanced functions (such as pass/fail test, waveform record) are also supported.

Print



pressing this key will save the screen to the USB storage device in “.png” format. If the current storage type is picture, the screen will be saved in the USB storage device in picture format (BMP8, BMP24, PNG and TIFF).

User Interface

DS1000Z provides 7.0 inches, WVGA (800*480) 160,000 color TFT LCD.

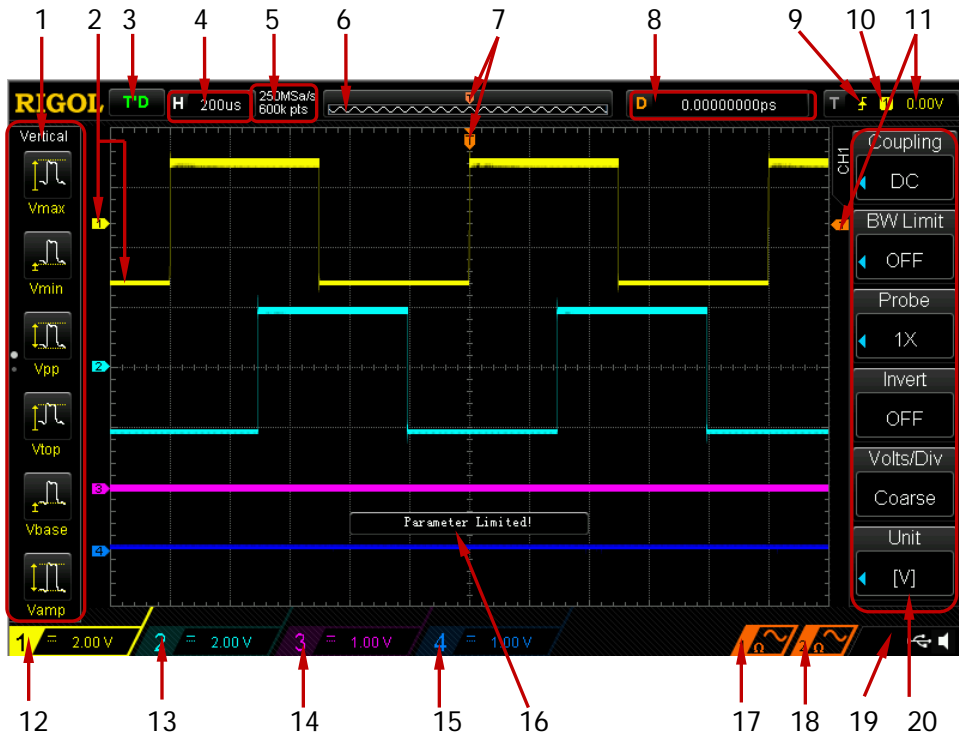

Figure 11 User Interface

1. Auto Measurement Items

Provide 12 horizontal (HORIZONTAL) and 12 vertical (VERTICAL) measurement parameters. Press the softkey at the left of the screen to activate the corresponding measurement item. Press **MENU** continuously to switch between the horizontal and vertical parameters.

2. Channel Label/Waveform

Different channels are marked by different colors and the color of the waveform complies with the color of the channel.

3. Status

Available states include RUN, STOP, T'D (triggered), WAIT and AUTO.

4. Horizontal Time Base

- Represent the time per grid on the horizontal axis on the screen.

- Use **HORIZONTAL**  **SCALE** to modify this parameter. The range available is from 5 ns to 50 s.

5. Sample Rate/Memory Depth

- Display the current sample rate and memory depth of the oscilloscope.
- Use **HORIZONTAL**  **SCALE** to modify this parameter.

6. Waveform Memory

Provide the schematic diagram of the memory position of the waveform currently on the screen.

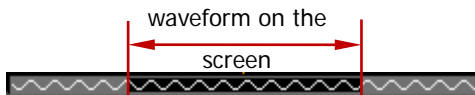

7. Trigger Position

Display the trigger position of the waveform in the waveform memory and on the screen.

8. Horizontal Position

Use **HORIZONTAL**  **POSITION** to modify this parameter. Press down the knob to automatically set the parameter to zero.

9. Trigger Type

Display the currently selected trigger type and trigger condition setting.

Different labels are displayed when different trigger types are selected.



For example:  represents triggering on the rising edge in "Edge" trigger.



10. Trigger Source

Display the trigger source currently selected (CH1-CH4 or AC Line). Different labels are displayed when different trigger sources are selected and the color of the trigger parameter area will change accordingly.



For example:  denotes that CH1 is selected as the trigger source.

11. Trigger Level



-  at the right of the screen is the trigger level label and the trigger level value is displayed at the upper-right corner of the screen.
- When using **TRIGGER**  **LEVEL** to modify the trigger level, the trigger level value will change with the up and down of .

Note: in slope trigger, runt trigger and windows trigger, there are two trigger level labels ( and .



12. CH1 Vertical Scale

- Display the voltage value per grid of CH1 waveform vertically.
- Use **VERTICAL**  **SCALE** to modify this parameter.
- The following labels will be displayed according to the current channel setting: channel coupling (e.g. ) and bandwidth limit (e.g. .



13. CH2 Vertical Scale

- Display the voltage value per grid of CH2 waveform vertically.
- Use **VERTICAL SCALE**  to modify this parameter.
- The following labels will be displayed according to the current channel setting: channel coupling (e.g. ) and bandwidth limit (e.g. )

14. CH3 Vertical Scale

- Display the voltage value per grid of CH3 waveform vertically.
- Use **VERTICAL SCALE**  to modify this parameter.
- The following labels will be displayed according to the current channel setting: channel coupling (e.g. ) and bandwidth limit (e.g. )



15. CH4 Vertical Scale

- Display the voltage value per grid of CH4 waveform vertically.
- Use **VERTICAL SCALE**  to modify this parameter.
- The following labels will be displayed according to the current channel setting: channel coupling (e.g. ) and bandwidth limit (e.g. )



16. Message Box

Display prompt messages.

17. Source1 Waveform



- Display the type of waveform currently set for Source1.
- When the modulation is enabled,  will be displayed at the bottom of the **Source1 Waveform**.
- When the impedance of signal source is set to 50 Ω,  will be displayed at the bottom of the **Source1 Waveform**.
- Only available to DS1104Z-S and DS1074Z-S.

18. Source2 Waveform

- Display the type of waveform currently set for Source1.
- When the modulation is enabled,  will be displayed at the bottom of the **Source2 Waveform**.
- When the impedance of signal source is set to 50 Ω,  will be displayed at the bottom of the **Source2 Waveform**.
- Only available to DS1104Z-S and DS1074Z-S.

19. Notification Area



Display system time, sound icon and USB disk icon.







- Sound Icon: when sound is enabled,  will be displayed. Press **Utility** → **Sound** to enable or disable the sound.
- USB Disk Icon: when a USB disk is detected,  will be displayed.

20. Operation MENU

Press any softkey to activate the corresponding menu.

The following symbols might be displayed in the menu:

-  Denote that  at the front panel can be used to select parameter items. The backlight of  turns on when parameter selection is valid.

-  Denote that you can use ↻ to adjust the parameter and then press down ↻ to select the parameter.
-  Denote that press ↻ to input desired parameter values directly using the pop-up numeric keyboard. The backlight of ↻ turns on when parameter input is valid.
-  Denote that the current menu has several options.
-  Denote that the current menu has a lower level menu.
-  Press this key to return to the previous menu.
-  The number of the dots denotes that the number of the pages the current menu has.

To Use the Security Lock

If needed, you can use the security lock (please buy it yourself) to lock the oscilloscope to a fixed location. The method is as follows, align the lock with the lock hole and plug it into the lock hole vertically, turn the key clockwise to lock the oscilloscope and then pull the key out.

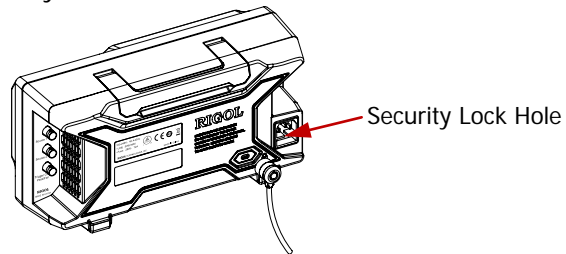

Figure 0-12 To Use the Security Lock

Note: please do not insert other articles into the security lock hole to avoid damaging the instrument.

To Use the Built-in Help System

The help system of this oscilloscope provides instructions for all the function keys (including menu keys) at the front panel. Press **Help** to open the help interface and press again to close the interface. The help interface mainly consists of two parts. The left is "Help Options" and you can use "Button" or "Index" mode to select. The right is "Help Display Area".

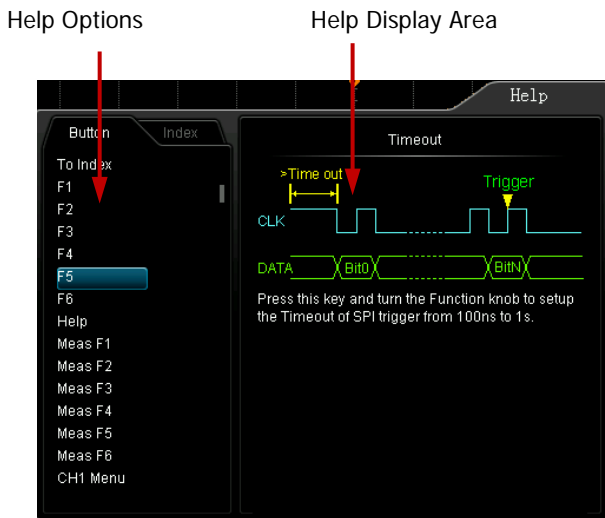







Figure 0-13 Help Information

Default mode. In this mode, you can press the button (except the power key , the knob  and the menu page up/down key ) at the front panel directly to get the corresponding help information in the "Help Display Area". Use  to select "To Index" and then press the knob to switch to **Index** mode.

Index:

In this mode, use  to select the item that needs to get help (for example, "Band Width"). Press the knob to get the corresponding help information in the "Help Display Area". Use  to select "To Button" and then press the knob to switch to **Button** mode.

Chapter 2 To Set the Vertical System

The contents of this chapter:

- [To Enable the Channel](#)
- [Channel Coupling](#)
- [Bandwidth Limit](#)
- [Probe Ratio](#)
- [Waveform Invert](#)
- [Vertical Scale](#)
- [Vertical Expansion](#)
- [Amplitude Unit](#)
- [Channel Label](#)

To Enable the Channel

DS1000Z provides 4 analog input channels (CH1-CH4) and each channel can be controlled independently. As the vertical system setting methods of the 2 channels are completely the same, this chapter takes CH1 as an example to introduce the setting method of the vertical system.

Connect a signal to the channel connector of any channel (for example, CH1) and then press **CH1** in the vertical control area (VERTICAL) at the front panel to enable CH1.

Screen:

The channel setting menu is displayed at the right side of the screen and the channel label at the bottom of the screen (as shown in the figure below) is highlighted. The information displayed in the channel label is related to the current channel setting.



After the channel is turned on, modify the parameters such as the vertical scale, the horizontal time base and the trigger mode according to the input signal to make the waveform display easy to observe and measure.

Channel Coupling

Set the coupling mode to filter out the undesired signals. For example, the signal under test is a square waveform with DC offset.

- When the coupling mode is "DC": the DC and AC components of the signal under test can both pass the channel.
- When the coupling mode is "AC": the DC components of the signal under test are blocked.
- When the coupling mode is "GND": the DC and AC components of the signal under test are both blocked.

Press **CH1** → **Coupling** and use  to select the desired coupling mode (the default is DC). The current coupling mode is displayed in the channel label at the bottom of the screen. You can also press **Coupling** continuously to switch the coupling mode.

Bandwidth Limit

Set the bandwidth limit to reduce display noise. For example, the signal under test is a pulse with high frequency oscillation.

- When bandwidth limit is disabled, the high frequency components of the signal under test can pass the channel.
- Enable bandwidth limit and limit the bandwidth to 20 MHz, the high frequency components that exceed 20 MHz are attenuated.

Press **CH1** → **BW Limit** and use  to enable or disable bandwidth limit (the default is OFF). When bandwidth limit (20 MHz) is enabled, the character "B" will be displayed in the channel label at the bottom of the screen. You can also press **BW Limit** continuously to switch between on and off of the bandwidth limit.



Probe Ratio

You can set the probe attenuation ratio manually. The probe ratio values available are as shown in the table below.

Table 0-1 Probe Attenuation Coefficient

Menu	Attenuation coefficient
0.01X	1:100
0.02X	1:50
0.05X	1:20
0.1X	1:10
0.2X	1:5
0.5X	1:2
1X	1:1
2X	2:1
5X	5:1
10X	10:1
20X	20:1
50X	50:1
100X	100:1
200X	200:1
500X	500:1
1000X	1000:1

Waveform Invert

When waveform invert is enabled, the waveform display rotates 180 degree relative to the ground potential. When waveform invert is disabled, the waveform display is normal. Press **CH1** → **Invert** to enable or disable waveform invert.

Vertical Scale

The vertical scale can be adjusted in “Coarse” or “Fine” mode.

Press **CH1** → **Volts/Div** to select the desired mode. Rotate **VERTICAL**  **SCALE** to adjust the vertical scale (clockwise to reduce the scale and counterclockwise to increase).

The scale information (such as ) in the channel label at the bottom of the screen will change accordingly during the adjustment. The adjustable range of the vertical scale is related to the probe ratio currently set. By default, the probe ratio is 1X and the adjustable range of the vertical scale is from 1 mV/div to 10 V/div.

- Coarse adjustment (take counterclockwise as an example): set the vertical scale in 1-2-5 step namely 1 mV/div, 2 mV/div, 5 mV/div, 10 mV/div...10 V/div.
- Fine adjustment: further adjust the vertical scale within a relatively smaller range to improve vertical resolution. If the amplitude of the input waveform is a little bit greater than the full scale under the current scale and the amplitude would be a little bit lower if the next scale is used, fine adjustment can be used to improve the amplitude of waveform display to view signal details.

Note: you can also press **VERTICAL**  **SCALE** to quickly switch between “Coarse” and “Fine” adjustments.

Vertical Expansion

When using **VERTICAL**  **SCALE** to change the vertical scale of the analog channel, you can choose to expand or compress the signal vertically around the center of the screen or the ground point of the signal.

Press **Utility** → **System** → **VerticalExp** to select “Center” or “Ground” and the default is “Ground”.

- Center: when the vertical scale is modified, the waveform will expand or compress around the center of the screen.
- Ground: when the vertical scale is modified, the waveform ground level will remain at the same point on the screen and the waveform will expand or compress around this point.

Amplitude Unit

Select the amplitude display unit for the current channel. The available units are W, A, V and U. When the unit is changed, the unit displayed in the channel label will change accordingly.

Press **CH1** → **Unit** to select the desired unit and the default is V.

Channel Label



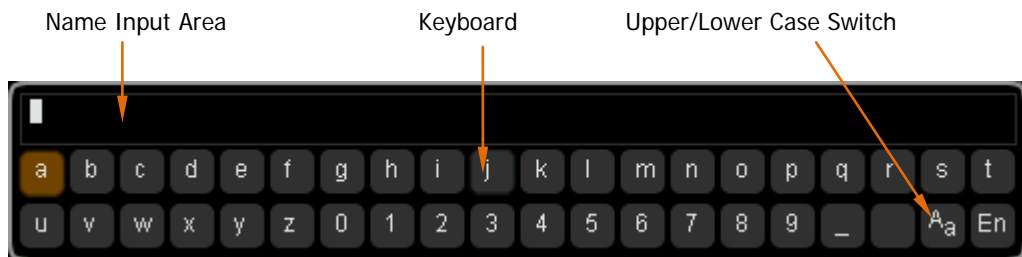

To identify different analog channels, you can set another label for each channel (such as **CH1**). Press **CH1** → **Label** to enter the label modification interface, you can use the built-in label or input the label manually and the length of the label can not exceed 4 characters. Note: only English input method can be used for this operation.

Press **Display** to turn on or off the display of channel label and the default is CH1.

Press **Label Edit** to enable the label editing interface as shown in the figure below.



For example, editing the label for "**Chn1**".

Press **Keyboard** to select the "Keyboard" area. Select "Aa" using  and press down  to switch it to "A". Select "C" using  and press down  to input the character. Use the same method to input "hn1".

To modify or delete the input character, press **Name** to select the "Name Input Area" and use  to select the character to be modified or deleted. Enter the desired character or press **Delete** to delete the character selected.

After finishing the input, press **OK** to finish the modification and if the display is turned on, another label **Chn1** will be set for the channel.

Chapter 3 To Set the Horizontal System

The contents of this chapter:

- [Delayed Sweep](#)
- [Time Base Mode](#)

Delayed Sweep

Delayed sweep can be used to enlarge a length of waveform horizontally to view the waveform details.

Press **MENU** in the horizontal control area (HORIZONTAL) at the front panel and press **Delayed** to enable or disable delayed sweep. Note that to enable delayed sweep, the current time base mode must be "YT".

In delayed sweep mode, the screen is divided into two display areas as shown in the figure below.

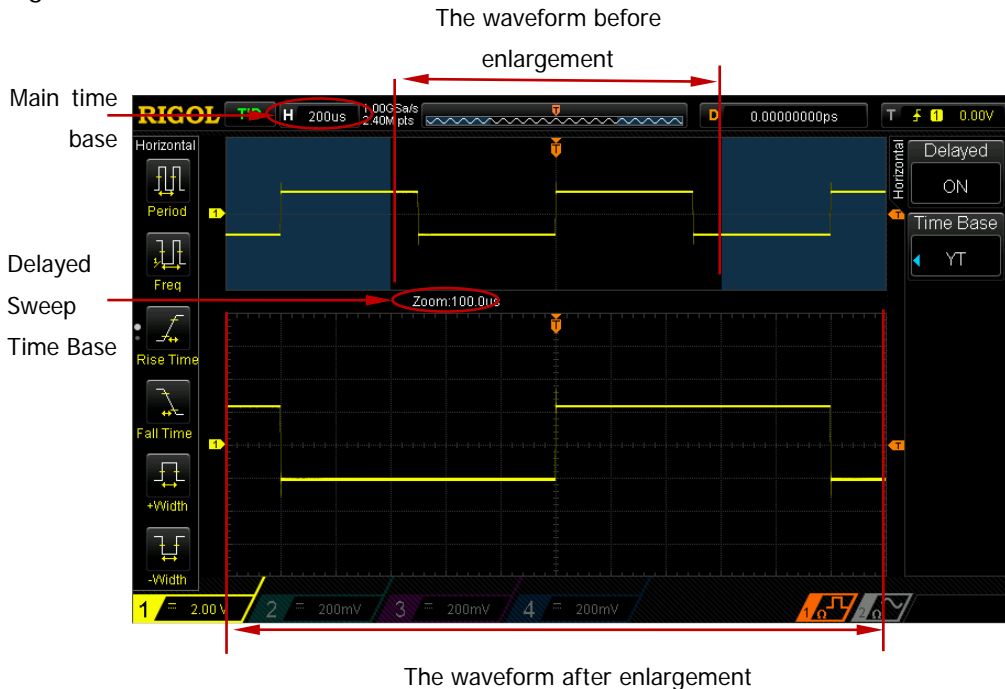

The waveform before enlargement:

The waveform in the area that has not been covered by the subtransparent blue in the upper part of the screen is the waveform before enlargement. You can turn **HORIZONTAL** **POSITION** to move the area left and right or turn **HORIZONTAL** **SCALE** to enlarge or reduce this area.

The waveform after enlargement:

The waveform in the lower part of the screen is the horizontally expanded waveform. Note: compared to the main time base, the delayed time base has increased the waveform resolution (as shown in the figure above). The delayed time base should be less than or equal to the main time base.

Tip

You can also press down **HORIZONTAL** **SCALE** (delayed sweep shortcut key) to directly switch to delayed sweep mode.

Time Base Mode

Press **MENU** in the horizontal control area (HORIZONTAL) at the front panel and then press **Time Base** to select the time base mode of the oscilloscope and the default is YT.

YT Mode

This mode is the main time base mode and is applicable to two input channels. In this mode, the Y axis represents voltage and the X axis represents time. Note that only when this mode is enabled can "[Delayed Sweep](#)" be turned on.

XY Mode

In this mode, the oscilloscope changes the two channels from voltage-time display mode to voltage-voltage display mode. The phase deviation between two signals with the same frequency can be easily measured via Lissajous method. The figure below shows the measurement schematic diagram of the phase deviation.

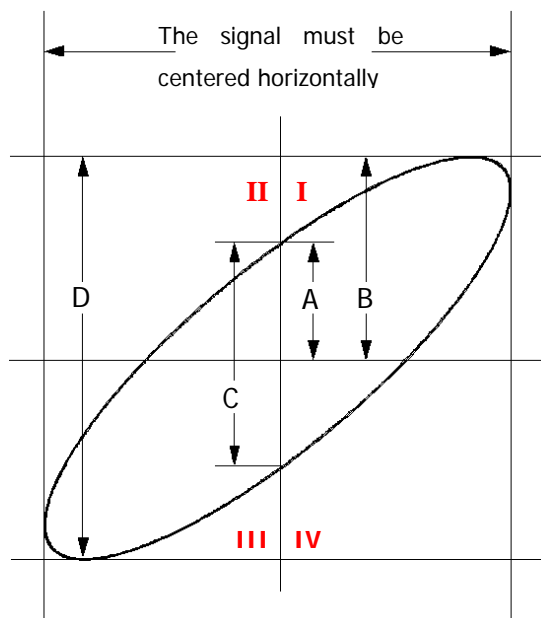

According to $\sin\theta = A/B$ or C/D (wherein, θ is the phase deviation angle between the two channels and the definitions of A, B, C and D are as shown in the figure above), the phase deviation angle is obtained, that is:



$$\theta = \pm \arcsin(A/B) \text{ or } \pm \arcsin(C/D)$$

If the principal axis of the ellipse is within quadrant I and III, the phase deviation angle obtained should be within quadrant I and IV, namely within $(0 \text{ to } \pi/2)$ or $(3\pi/2 \text{ to } 2\pi)$. If the principal axis of the ellipse is within quadrant II and IV, the phase deviation angle obtained should be within quadrant II and III, namely within $(\pi/2 \text{ to } \pi)$ or $(\pi \text{ to } 3\pi/2)$.

XY function can be used to measure the phase deviation occurred when the signal under test passes through a circuit network. Connect the oscilloscope to the circuit to monitor the input and output signals of the circuit.

Application example: measure the phase deviation of the input signals of two channels.

Method 1: Use Lissajous method

1. Connect a sine signal to CH1 and then connect a sine signal with the same frequency and amplitude but a 90° phase deviation to CH2.
2. Press **AUTO** and adjust the vertical position of CH1 and CH2 to 0.
3. Press **X-Y** to select "CH1-CH2", rotate **Horizontal**  **SCALE** to adjust the sample rate properly to get better Lissajous figure for better observation and measurement.
4. Rotate **VERTICAL**  **POSITION** to adjust CH1 and CH2 to get better observation of signals. At this point, the circle as shown in the figure below should be displayed.

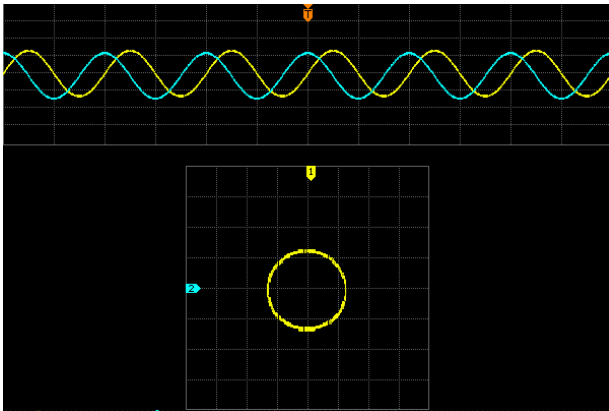

5. As shown in the figure above, the distances from the crossing points of axis and the circle to the origin of the coordinates are approximately equal. Thus, the phase deviation angle $\theta = \pm \arcsin 1 = 90^\circ$.

Note:

- In YT mode, the oscilloscope could use any sample rate (within the guaranteed range) to capture waveform. The maximum sample rate of XY mode is 500 MSa/s. Generally, reducing the sample rate properly could improve the display effect of Lissajous figure.
- When XY mode is enabled, "**Delayed Sweep**" will be disabled automatically.
- Press X-Y to select "CH1-CH2, CH1-CH3, CH1-CH4, CH2-CH3, CH2-CH4,

CH3-CH4" and the two channels corresponding will be enabled automatically and disabled the other two channels at the same time. X axis traces the voltage of the later channel of each option and Y axis traces the voltage of the former channel of each option.

- The following functions are not available in XY mode:
Auto measure, cursor measure, math operation, reference waveform, delayed sweep, vector display, **HORIZONTAL**  **POSITION**, trigger control, memory depth, acquisition mode, Pass/Fail test and waveform record.

Method 2: Use the shortcut measurement function

Please refer to "Phase A→B $\frac{f}{t}$ " and "Phase A→B $\frac{t}{f}$ " measurement functions of "Delay and Phase" on page [6-21](#).

Roll Mode

In this mode, the waveform scrolls from the right to the left to update the display and the waveform horizontal position and trigger control are not available. The range of horizontal scale adjustment is from 200.0 ms to 1.000 ks.

Note: when Roll mode is enabled, "[Delayed Sweep](#)", and "[5 To Trigger the Oscilloscope](#)" are not available.

Slow Sweep

Another mode similar to Roll mode. When the horizontal time base is set to 200 ms/div or slower, the instrument enters "slow sweep" mode in which the instrument first acquires the data at the left of the trigger point and then waits for trigger event. After the trigger occurs, the instrument continues to finish the waveform at the right of the trigger point. When slow sweep mode is used to observe low frequency signal, it is recommended that the [Channel Coupling](#) is set to "DC".

Chapter 4 To Set the Sample System

The contents of this chapter:

- [Acquisition Mode](#)
- [Sample Rate](#)
- [Memory Depth](#)

Acquisition Mode

The acquisition mode is used to control how to generate waveform points from sample points.

Press **Acquire** → **Mode** in the function menu at the front panel and use  to select the desired acquisition mode (the default is normal), then press down the knob to select this mode. You can also press **Mode** continuously to switch the acquisition mode.

Normal

In this mode, the oscilloscope samples the signal at equal time interval to rebuild the waveform. For most of the waveforms, the best display effect can be obtained using this mode.

Average

In this mode, the oscilloscope averages the waveforms from multiple samples to reduce the random noise of the input signal and improve the vertical resolution. The greater the number of averages is, the lower the noise will be and the higher the vertical resolution will be but the slower the response of the displayed waveform to the waveform changes will be.

The available range of the number of averages is from 2 to 8192 and the default is 2. When "Average" mode is selected, press **Averages** and use  to set the desired number of averages as the power function of 2.

The Waveform before Average:

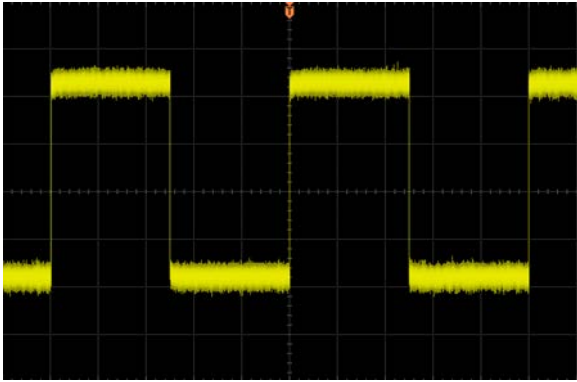

The Waveform after 256 Averages:

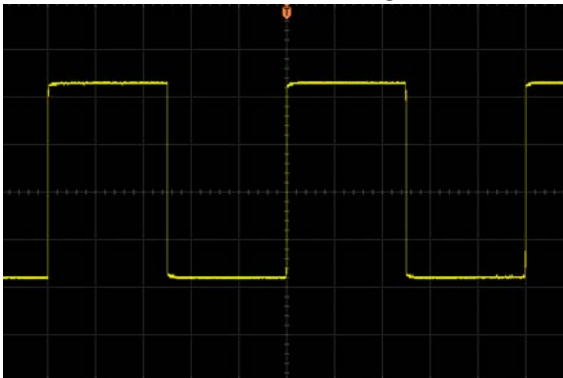

Peak Detect

In this mode, the oscilloscope acquires the maximum and minimum values of the signal within the sample interval to get the envelope of the signal or the narrow pulse of the signal that might be lost. In this mode, signal confusion can be prevented but the noise displayed would be larger.

In this mode, the oscilloscope can display all the pulses with pulse widths at least as wide as the sample period.

High Resolution

This mode uses a kind of ultra-sample technique to average the neighboring points of the sample waveform to reduce the random noise on the input signal and generate much smoother waveforms on the screen. This is generally used when the sample rate of the digital converter is higher than the storage rate of the acquisition memory.

Note: "Average" and "High Res" modes use different averaging methods. The former uses "multiple sample average" and the latter uses "single sample average".

Sin(x)/x

Press **Sin(x)/x** to enable or disable the dynamic sine interpolation function. Enable the dynamic sine interpolation can restore the original waveform more real.

Sample Rate

The sample rate of this oscilloscope is up to 1 GSa/s. Note that the sample rate is displayed in the status bar at the upper side of the screen and in the **Sa Rate** menu and can be changed by adjusting the horizontal time base (s/div) through **HORIZONTAL**  **SCALE** or modifying the memory depth.

The influence on the waveform when the sample rate is too low:

1. **Waveform Distortion:** when the sample rate is too low, some waveform details are lost and the waveform displayed is rather different from the actual signal.

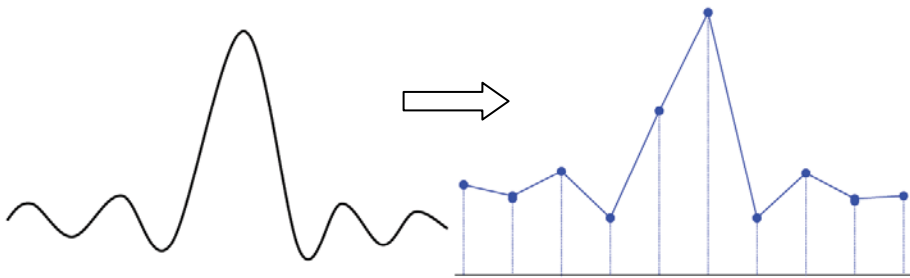

2. **Waveform Confusion:** when the sample rate is lower than twice the actual signal frequency (Nyquist Frequency), the frequency of the waveform rebuilt from the sample data is lower than the actual signal frequency. The most common aliasing is the jitter on fast edge.

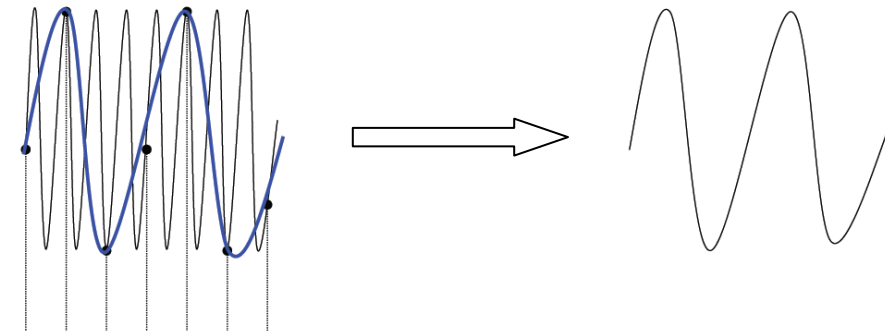

3. **Waveform Leakage:** when the sample rate is too low, the waveform rebuilt from the sample data does not reflect all the actual signal information.

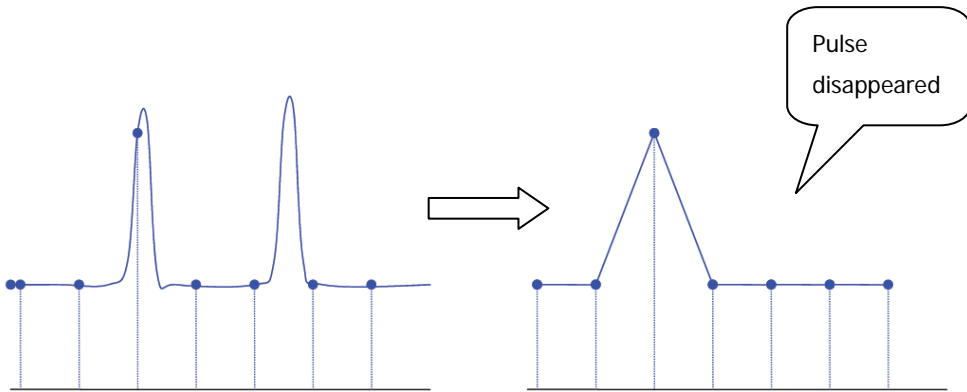

Memory Depth

Memory depth refers to the number of waveform points that the oscilloscope can store in a single trigger sample and it reflects the storage ability of the sample memory. DS1000Z provides up to 24 Mpts memory depth (option) and 12 Mpts standard memory depth.

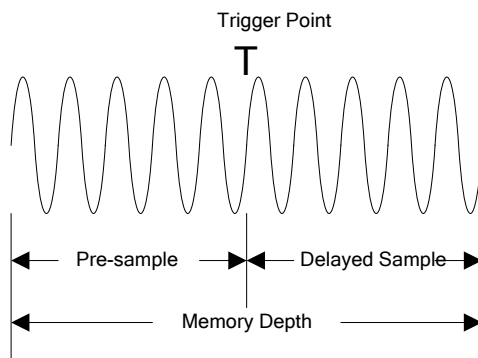

The relation of memory depth, sample rate and waveform length fulfills the equation below:

$$\text{Memory depth} = \text{sample rate (Sa/s)} \times \text{waveform length (s/div} \times \text{div)}$$

Thus, in the same time base, the higher memory depth can ensure a higher sample rate.

Press **Acquire** → **Mem Depth**, use  to switch to the desired memory depth (the default is auto) and then press down the knob to select the option. You can also press **Mem Depth** continuously to switch the memory depth.

When a single channel is enabled, the memory depths available include Auto, 12kPoints, 120kPoints, 1200kPoints, 12MPoints. In "Auto" mode, the oscilloscope selects the memory depth automatically according to the current sample rate.

When two channels are enabled, the memory depths available include Auto, 6kPoints, 60kPoints, 600kPoints, 6MPoints. In "Auto" mode, the oscilloscope selects the memory depth automatically according to the current sample rate.

When four channels are enabled, the memory depths available include Auto, 3kPoints, 30kPoints, 300kPoints, 3MPoints. In "Auto" mode, the oscilloscope selects the memory depth automatically according to the current sample rate.

Chapter 5 To Trigger the Oscilloscope

For trigger, you set certain trigger condition according to the requirement and when a waveform in the waveform stream meets this condition, the oscilloscope captures this waveform as well as the neighbouring part and displays them on the screen. For digital oscilloscope, it displays waveform continuously no matter whether it is stably triggered, but only stable trigger can ensure stable display. The trigger circuit ensures that every time base sweep or acquisition starts from the input signal and the user-defined trigger condition, namely every sweep is synchronous to the acquisition and the waveforms acquired overlap to display stable waveform.

Trigger setting should be based on the features of the input signal, thus you need to have some knowledge of the signal under test to quickly capture the desired waveform. This oscilloscope provides abundant advanced trigger functions which can help you to focus on the desired waveform details.

The contents of this chapter:

- [Trigger Source](#)
- [Trigger Mode](#)
- [Trigger Coupling](#)
- [Trigger Holdoff](#)
- [Noise Rejection](#)
- [Trigger Type](#)
- [Trigger Output Connector](#)

Trigger Source

Press **MENU** → **Source** in the trigger control area (TRIGGER) at the front panel to select the desired trigger source. Signals input from CH1-CH4 and AC Line can all be used as trigger source.

Analog channel input:

Signals input from analog channels CH1-CH4 can all be used as the trigger source. No matter whether the input of the channel selected is enabled, the channel can work normally.

AC line:

The trigger signal is obtained from the AC power input of the oscilloscope. This kind of signals can be used to display the relationship between signal (such as illuminating device) and power (power supply device). For example, to stably trigger the waveform output from the transformer of a transformer substation, which is mainly used in related measurement of the power industry.

Trigger Mode

Trigger mode affects the way in which the oscilloscope searches for the trigger. The following is the schematic diagram of the acquisition memory. As shown in the figure below, the position of the trigger event is determined by the reference time point and the delay setting. Note that the acquisition memory of the oscilloscope is a cyclic buffer and the new data would overwrite the old data until the acquisition finishes.

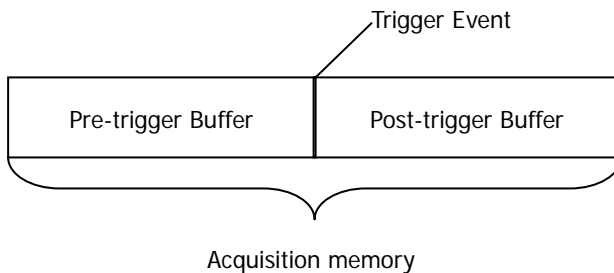

Pre-trigger/Delayed trigger:

Acquire data before/after the trigger event. The trigger position is usually at the horizontal center of the screen. In full-screen display, six-grid pre-trigger and delayed trigger information are displayed respectively. You can adjust the horizontal position of the waveform through **HORIZONTAL**  **POSITION** to view more pre-trigger information and delayed trigger information, through which the signal information before/after the trigger (such as capture the glitch generated by the circuit and analyze the pre-trigger data to find out the reasons for glitch) can be obtained.

Press **MODE** in the trigger control area (TRIGGER) at the front panel or press **MENU** → **Sweep** to select the desired trigger mode. The corresponding status light of the mode currently selected turns on.

Auto:

No matter whether the trigger condition is met, there is always waveform display. A horizontal line is displayed when no signal is input.

In this mode, the oscilloscope operates by first filling the pre-trigger buffer. It starts searching for a trigger after the pre-trigger buffer is filled and continues to flow data through this buffer while it searches for the trigger. While searching for the trigger, the oscilloscope overflows the pre-trigger buffer and the first data put into the buffer

is first pushed out (First Input First Out, FIFO). When a trigger is found, the pre-trigger buffer would contain the data acquired just before the trigger. If no trigger is found, the oscilloscope will trigger forcefully. If forceful trigger is invalid, the oscilloscope still displays waveform but the waveform is not stable; if forceful trigger is valid, the oscilloscope displays stable waveform.

This trigger mode is applicable to low-repetitive-rate signals and unknown signal levels. To display DC signals, you must use auto trigger mode.

Note: when the horizontal time base is set to 50 ms/div or greater, this trigger mode allows the absence of trigger signal.

Normal:

Display waveform when the trigger condition is met; otherwise, the oscilloscope holds the original waveform and waits for the next trigger.

In this mode, the oscilloscope fills the pre-trigger buffer first and then search for a trigger while at the same time continues filling data. While searching for the trigger, the oscilloscope overflows the pre-trigger buffer and the first data put into the buffer is first pushed out (FIFO). When a trigger is found, the oscilloscope will fill the post-trigger buffer and display the acquisition memory.

Use normal trigger mode for low-repetitive-rate signals or when auto trigger is not required.

Note: in this mode, pressing **FORCE** can generate a trigger signal forcefully.

Single:

When this mode is selected, the backlight of **SINGLE** turns on. The oscilloscope waits for a trigger and displays the waveform when the trigger condition is met and then stops.

Note: in this mode, pressing **FORCE** can generate a trigger signal forcefully.

Trigger Coupling

Trigger coupling decides which kind of components will be transmitted to the trigger circuit. Please distinguish it with "[Channel Coupling](#)".

- DC: allow DC and AC components into the trigger path.
- AC: block all the DC components and attenuate signals lower than 75 kHz.
- LF Reject: block the DC components and reject the low frequency components (lower than 75 kHz).
- HF Reject: reject the high frequency components (higher than 75 kHz).

Press **MENU** → **Setting** → **Coupling** in the trigger control area (TRIGGER) at the front panel to select the desired coupling type (the default is DC). Note that trigger coupling is only valid in edge trigger.

Trigger Holdoff

Trigger holdoff can be used to stably trigger the complex waveforms (such as pulse series). Holdoff time is the amount of time that the oscilloscope waits before re-arming the trigger circuitry. The oscilloscope will not trigger until the holdoff time expires.

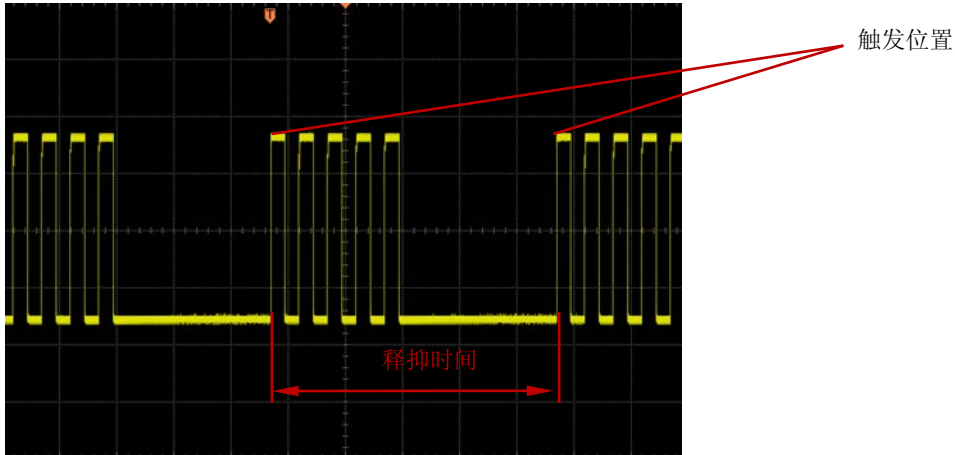

Press **MENU** → **Setting** → **Holdoff** in the trigger control area (TRIGGER) at the front panel and use  to modify the holdoff time (the default is 16 ns) until the waveform triggers stably. The adjustable range of holdoff time is from 16 ns to 10 s. Note that trigger holdoff is not available for video trigger.

Noise Rejection

Noise Rejection adds additional trigger sensitivity. Noise rejection reduces the possibility of noise trigger but also reduces the trigger sensitivity; therefore, a larger signal is required to trigger the oscilloscope.

Press **MENU** → **Setting** → **Noise Reject** in the trigger control area (TRIGGER) at the front panel to enable or disable noise rejection.

Trigger Type

DS1000Z provides various trigger functions, including various serial bus triggers.

- [Edge Trigger](#)
- [Pulse Trigger](#)
- [Slope Trigger](#)
- [Video Trigger](#)
- [Pattern Trigger](#)
- [Duration Trigger](#)
- [Setup/Hold Trigger](#)
- [TimeOut Trigger \(Option\)](#)
- [Runt Trigger \(Option\)](#)
- [Windows Trigger \(Option\)](#)
- [Delay Trigger \(Option\)](#)
- [Nth Edge Trigger \(Option\)](#)
- [RS232 Trigger \(Option\)](#)
- [I2C Trigger \(Option\)](#)
- [SPI Trigger \(Option\)](#)

Edge Trigger

Trigger on the trigger threshold of the specified edge of the input signal.

Trigger Type:

Press **Type** to select "Edge". At this point, the trigger setting information as shown in the figure below is displayed at the upper right corner of the screen.



Source Selection:

Press **Source** to select CH1-CH4 or AC Line as the **Trigger Source**. The current trigger source is displayed at the upper right corner of the screen.

Note: select channel with signal input as trigger source to obtain stable trigger.

Edge Type:

Press **Slope** to select the kind of edge of the input signal on which the oscilloscope triggers. The current edge type is displayed at the upper right corner of the screen.

- : trigger on the rising edge of the input signal when the voltage level meets the preset trigger level.
- : trigger on the falling edge of the input signal when the voltage level meets the preset trigger level.
- : trigger on the rising and falling edges of the input signal when the voltage level meets the preset trigger level.

Trigger Mode:

Press **Sweep** to select the **Trigger Mode** (page 5-3) under this trigger type as auto, normal or single. The corresponding status light of the current trigger mode turns on.

Trigger Setting:

Press **Setting** to set the trigger parameters (trigger coupling, trigger holdoff and noise rejection) under this trigger type.

Trigger Level:

Trigger occurs only when the signal reaches the preset trigger level.

Use **TRIGGER** **LEVEL** to modify the level. An orange trigger level line and the trigger mark "" appear on the screen and move up and down with the rotation of the knob, while at the same time, the trigger level value (such as **Trig Level : 164mV**) at the lower left corner of the screen also changes accordingly. When stopping turning the knob, the trigger level line and the trigger mark disappear in about 2 s.

Pulse Trigger

Trigger on the positive or negative pulse with a specified width.

Trigger Type:

Press **Type** to select "Pulse". At this point, the trigger setting information as shown in the figure below is displayed at the upper right corner of the screen.



Source Selection:

Press **Source** to select CH1-CH4 as the [Trigger Source](#). The current trigger source is displayed at the upper right corner of the screen.

Note: select channel with signal input as trigger source to obtain stable trigger.

Pulse Condition:







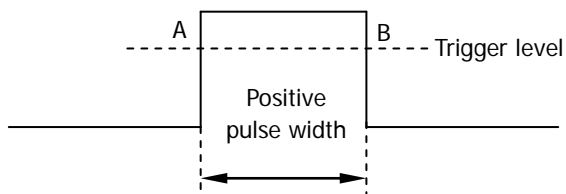

Press **When** to select the desired pulse condition.

- : trigger when the positive pulse width of the input signal is greater than the specified pulse width.
- : trigger when the positive pulse width of the input signal is lower than the specified pulse width.
- : trigger when the positive pulse width of the input signal is greater than the specified lower limit of pulse width and lower than the upper limit of pulse width.
- : trigger when the negative pulse width of the input signal is greater than the specified pulse width.
- : trigger when the negative pulse width of the input signal is lower than the specified pulse width.
- : trigger when the negative pulse width of the input signal is greater than the specified lower limit of pulse width and lower than the upper limit of pulse width.

Pulse Width Setting:

In this oscilloscope, positive pulse width is defined as the time difference between the two crossing points of the trigger level and positive pulse as shown in the figure below.



- When the **Pulse Condition** is set to , ,  or , press **Setting** and use  to input the desired value. The range available is from 8 ns to 10 s.
- When the **Pulse Condition** is set to  or , press **Upper Limit** and **Lower Limit** and use  to input the desired values respectively. The range of the upper limit is from 16 ns to 10 s. The range of the lower limit is from 8 ns to 9.99 s. Note that the lower limit of the pulse width must be lower than the upper limit.

Trigger Mode:

Press **Sweep** to select the [Trigger Mode](#) (page [5-3](#)) under this trigger type as auto, normal or single. The corresponding status light of the current trigger mode turns on.

Trigger Setting:

Press **Setting** to set the trigger parameters (trigger holdoff and noise rejection) under this trigger type.

Trigger Level:

Use **TRIGGER**  **LEVEL** to modify the level. For details, please refer to the description of "[Trigger Level](#)" on page [5-9](#).

Slope Trigger

Trigger on the positive or negative slope of specified time.

Trigger Type:

Press **Type** to select "Slope". At this point, the trigger setting information as shown in the figure below is displayed at the upper right corner of the screen.



Source Selection:

Press **Source** to select CH1-CH4 as the [Trigger Source](#). The current trigger source is displayed at the upper right corner of the screen.

Note: select channel with signal input as trigger source to obtain stable trigger.

Slope Condition:

Press **When** to select the desired slope condition.

- : trigger when the positive slope time of the input signal is greater than the specified time.
- : trigger when the positive slope time of the input signal is lower than the specified time.
- : trigger when the positive slope time of the input signal is greater than the specified lower limit of time and lower than the specified upper limit of time.
- : trigger when the negative slope time of the input signal is greater than the specified time.
- : trigger when the negative slope time of the input signal is lower than the specified time.
- : trigger when the negative slope time of the input signal is greater than the specified lower limit of time and lower than the specified upper limit of time.

Time Setting:

In this oscilloscope, positive slope time is defined as the time difference between the two crossing points of trigger level line A and B with the positive edge as shown in the figure below.

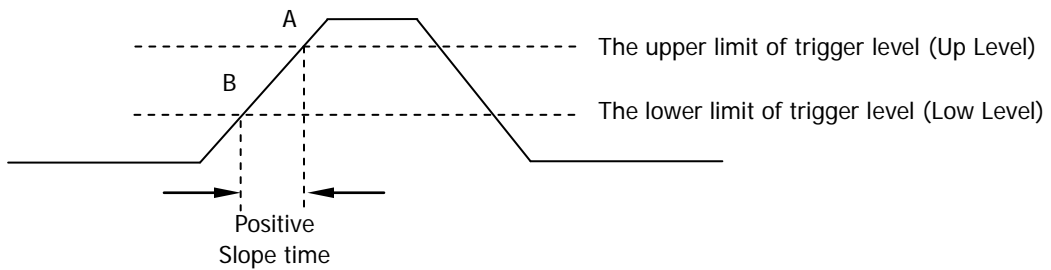

- When the **Slope Condition** is set to , , or , press **Time** and use to input the desired value. The range available is from 8 ns to 10 s.
- When the **Slope Condition** is set to or , press **Upper Limit** and **Lower Limit** and use to input the desired values respectively. The range of time upper limit is from 16 ns to 10 s. The range of the time lower limit is from 8 ns to 9.99 s. Note that the time lower limit must be lower than the upper limit.

Vertical Window:

Press **Vertical** to select the desired vertical window. Note that under the “Slope” trigger menu, you can also press down the trigger level knob continuously to switch the vertical window.

You can select the boundaries of the trigger level and then use **TRIGGER** **LEVEL** to adjust the trigger level. During the adjustment, two orange trigger level lines and two trigger marks (and) appear on the screen and move up and down with the rotation of the knob, while at the same time, the trigger level value and the slope value are displayed at the lower left corner of the screen. When stopping turning the knob, the trigger level lines and trigger marks disappear in about 2 s. When the **Slope Condition** is set to or , the current trigger level and slope range will be displayed at the lower left corner of the screen.

```
Up Level : 12.4 V
Low Level : 0.00V
Slew Rate : 12.4MV/s
```



$$\text{SlewRate} = \frac{\text{UpLevel} - \text{LowLevel}}{\text{Time}}$$

```
Up Level : 9.80 V
Low Level : 0.00V
Min Rate : 9.7MV/s
Max Rate : 9.8MV/s
```

$$\text{MinRate} = \frac{\text{UpLevel} - \text{LowLevel}}{\text{MaxTime}}$$

$$\text{MaxRate} = \frac{\text{UpLevel} - \text{LowLevel}}{\text{MinTime}}$$

The adjustment mode of the trigger level is different when different vertical window is selected.

- : only adjust the upper limit of the trigger level. During the adjustment, "UP Level" and "Slew Rate" change accordingly but "Low Level" remains unchanged.
- : only adjust the lower limit of the trigger level. During the adjustment, "Low Level" and "Slew Rate" change accordingly but "UP Level" remains unchanged.
- : adjust the upper and lower limits of the trigger level at the same time. During the adjustment, "UP Level" and "Low Level" change accordingly but "Slew Rate" remains unchanged.

Trigger Mode:

Press **Sweep** to select the [Trigger Mode](#) (page [5-3](#)) under this trigger type as auto, normal or single. The corresponding status light of the current trigger mode turns on.

Trigger Setting:

Press **Setting** to set the trigger parameters (trigger holdoff and noise rejection) under this trigger type.

Video Trigger

Trigger on the standard video signal field or line of NTSC (National Television Standards Committee), PAL (Phase Alternating Line), SECAM (sequential color with memory) or HDTV (High Definition Television).

Trigger Type:

Press **Type** to select "Video". At this point, the trigger setting information as shown in the figure below is displayed at the upper right corner of the screen.



Source Selection:

Press **Source** to select CH1-CH4 as the [Trigger Source](#). The current trigger source is displayed at the upper right corner of the screen.

Note: select channel with signal input as trigger source to obtain stable trigger.

Video Polarity:

Press **Polarity** to select the desired video polarity. The polarities available are normal polarity (▮▮) and inverted polarity (▮▮).

Sync:

Press **Sync** to select the desired sync type.

- All Lines: trigger on all the horizontal sync pulses.
- Line Num: for NTSC and PAL/SECAM video standards, trigger on the specified line in the odd or even field; for HDTV video standard, trigger on the specified line. Note that when this sync trigger mode is selected, you can modify the line number using ↻ in the **Line Num** menu with a step of 1. The range of the line number is from 1 to 525 (NTSC), 1 to 625 (PAL/SECAM), 1 to 525 (480P), 1 to 625 (576P).
- Odd field: trigger on the rising edge of the first ramp waveform pulse in the odd field.
- Even field: trigger on the rising edge of the first ramp waveform pulse in the even field.

Video Standard:

Press **Standard** to select the desired video standard.

- NTSC: the field frequency is 60 fields per second and the frame frequency is 30 frames per second. The TV sweep line is 525 with the even field goes first and the odd field follows behind.

- PAL: the frame frequency is 25 frames per second. The TV sweep line is 625 with the odd field goes first and the even field follows behind.
- SECAM: the frame frequency is 25 frames per second. The sweep line is 625 with interlacing sweep.
- HDTV: HDTV consists of 480P and 576P display formats. The specified video standards are as follows:

480P	the frame frequency is 60 frames per second; the TV sweep line is 525; line-by-line sweep; the line frequency is 31.5 kHz.
576P	the frame frequency is 60 frames per second; the TV sweep line is 625; line-by-line sweep.

Trigger Mode:

Press **Sweep** to select the [Trigger Mode](#) (page [5-3](#)) under this trigger type as auto, normal or single. The corresponding status light of the current trigger mode turns on.

Trigger Setting:

Press **Setting** to set the trigger parameter (noise rejection) under this trigger type.

Trigger Level:

Use **TRIGGER**  **LEVEL** to modify the level. For details, please refer to the description of "[Trigger Level](#)" on page [5-9](#).

Pattern Trigger

Identify a trigger condition by looking for a specified pattern. This pattern is a logical “AND” combination of the two channels. Each channel can have a value of high (H), low (L) or don’t care (X). A rising or falling edge can be specified for one channel included in the pattern. When an edge is specified, the oscilloscope will trigger at the edge specified if the pattern set for the other channel is true (H or L). If no edge is specified, the oscilloscope will trigger on the last edge that makes the pattern true. If both the channels in the pattern are set to “Don’t Care”, the oscilloscope will not trigger.

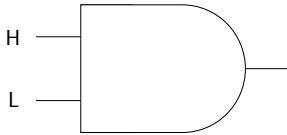

Trigger Type:

Press **Type** to select “Pattern”. At this point, the trigger setting information as shown in the figure below is displayed at the upper right corner of the screen.



Channel Selection:

Press **Source** to select CH1-CH4 as the channel source for H, L, X or edge condition. The current signal source is displayed at the upper right corner of the screen.

Pattern Setting:

Press **Code** to set the pattern of the current channel. At this point, the pattern setting area (as shown in the figure below) is displayed at the bottom of the screen.



- **H**: set the pattern of the channel selected to “H”, namely the voltage level is higher than the threshold level of the channel.
- **L**: set the pattern of the channel selected to “L”, namely the voltage level is lower than the threshold level of the channel.
- **X**: set the pattern of the channel selected to “Don’t Care”, namely this channel is not used as a part of the pattern. When both the channels in the pattern are set to “Don’t Care”, the oscilloscope will not trigger.
- **↗** or **↘**: set the pattern to the rising or falling edge of the channel selected.

Note: only one rising or falling edge can be specified in the pattern. If one edge item is currently defined and then another edge item is defined in another channel in the pattern, the former edge item defined will be replaced by X.

Trigger Mode:

Press **Sweep** to select the [Trigger Mode](#) (page [5-3](#)) under this trigger type as auto, normal or single. The corresponding status light of the current trigger mode turns on.

Trigger Setting:

Press **Setting** to set the trigger parameters (trigger holdoff and noise rejection) under this trigger type.

Trigger Level:

Use **TRIGGER**  **LEVEL** to modify the level. For details, please refer to the description of "[Trigger Level](#)" on page [5-9](#). Note that the trigger level of each channel needs to be set respectively.

Duration Trigger

Identify a trigger condition by looking for the duration of a specified pattern. This pattern is a logical “AND” combination of the two channels. Each channel can have a value of high (H), low (L) or don't care (X). The instrument triggers when the duration (ΔT) of this pattern meets the preset time, as shown in the figure below.

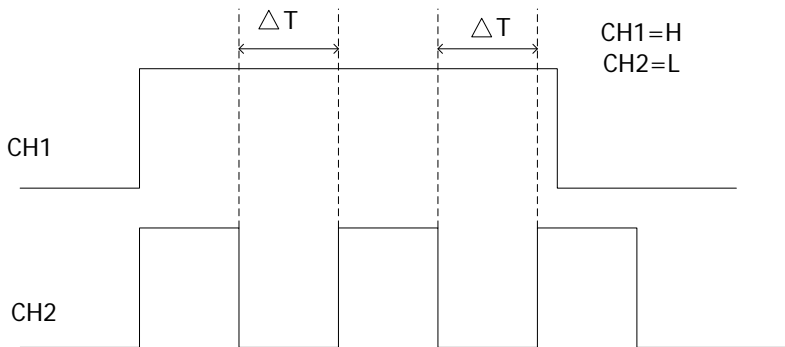

Trigger Type:

Press **Type** to select “Duration”. At this point, the trigger setting information as shown in the figure below is displayed at the upper right corner of the screen.



Source Selection:

Press **Source** to select CH1-CH4 as the channel source of H, L or X. The current signal source is displayed at the upper right corner of the screen.

Pattern Setting:

Press **Code** to set the pattern of the current channel. At this point, the pattern setting area (as shown in the figure below) is displayed at the bottom of the screen.



- **H**: set the pattern of the channel selected to “H”, namely the voltage level is higher than the threshold level of the channel.
- **L**: set the pattern of the channel selected to “L”, namely the voltage level is lower than the threshold level of the channel.
- **X**: set the pattern of the channel selected to “Don't Care”, namely this channel is not used as a part of the pattern. When both the channels in the pattern are set to “Don't Care”, the oscilloscope will not trigger.

Trigger Condition:

Press **When** to select the desired trigger condition.

- **>**: trigger when the duration of the pattern is greater than the preset time. Press **Time** to set the duration of duration trigger and the range is from 8 ns to 10 s.
- **<**: trigger when the duration of the pattern is lower than the preset time. Press **Time** to set the duration of duration trigger and the range is from 8 ns to 10 s.
- **<>**: trigger when the duration of the pattern is lower than the upper limit of the preset time and greater than the lower limit of the preset time. Press **Upper Limit** to set the upper limit of the duration of duration trigger and the range is from 16 ns to 10 s. Press **Lower Limit** to set the lower limit of the duration of duration trigger and the range is from 8 ns to 9.99 s. Note that the time lower limit must be lower than the time upper limit.

Trigger Mode:

Press **Sweep** to select the [Trigger Mode](#) (page [5-3](#)) under this trigger type as auto, normal or single. The corresponding status light of the current trigger mode turns on.

Trigger Setting:

Press **Setting** to set the trigger parameters (trigger holdoff and noise rejection) under this trigger type.

Trigger Level:

Use **TRIGGER**  **LEVEL** to modify the level. For details, please refer to the description of "[Trigger Level](#)" on page [5-9](#). Note that the trigger level of each channel needs to be set respectively.

Setup/Hold Trigger

Trigger when the internal state of the setup or hold time relative to the clock edge is changed by the logic data input, namely trigger when the setup time ($\Delta T1$) is less than the preset setup time or when the hold time ($\Delta T2$) is less than the preset hold time, as shown in the figure below.

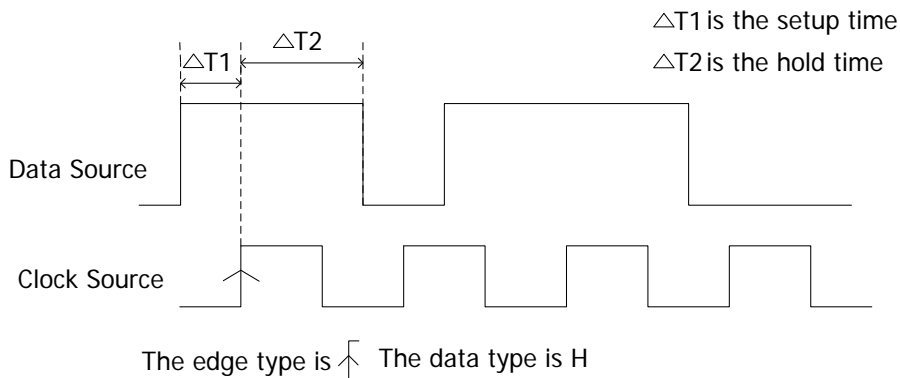

Trigger Type:

Press **Type** to select "Setup/Hold". At this point, the trigger setting information as shown in the figure below is displayed at the upper right corner of the screen.



Source Selection:

Press **DataSrc** and **ClkSrc** to set the data sources of the data line and clock line respectively. They can be set to CH1-CH4 and the current data sources are displayed at the upper right corner of the screen.

Edge Type:

Press **Slope** to select the desired clock edge type and it can be set to the rising edge or falling edge.

Data Type:

Press **Pattern** to set the effective pattern of the data signal to H (high level) or L (low level).

Setup Type:

Press **SetupType** to select the desired setup type.

- **Setup**: set the time that the data stays stable and constant before the clock edge appears. Press **Setup** to set the setup time and the range is from 8 ns to 1 s.
- **Hold**: set the time that the data stays stable and constant after the clock edge appears. Press **Hold** to set the hold time and the range is from 8 ns to 1 s.
- **SetupHold**: set the time that the data stays stable and constant before and after the clock edge appears. Press **Setup** and **Hold** to set the setup time and hold time respectively and the range is from 8 ns to 1 s.

Trigger Mode:

Press **Sweep** to select the [Trigger Mode](#) (page [5-3](#)) under this trigger type as auto, normal or single. The corresponding status light of the current trigger mode turns on.

Trigger Setting:

Press **Setting** to set the trigger parameters (trigger holdoff and noise rejection) under this trigger type.

Trigger Level:

Use **TRIGGER**  **LEVEL** to modify the level. For details, please refer to the description of "[Trigger Level](#)" on page [5-9](#).

TimeOut Trigger (Option)

Trigger when the time interval (ΔT) from when the rising edge (or falling edge) of the input signal passes through the trigger level to when the neighbouring falling edge (or rising edge) passes through the trigger level is greater than the timeout time set, as shown in the figure below.

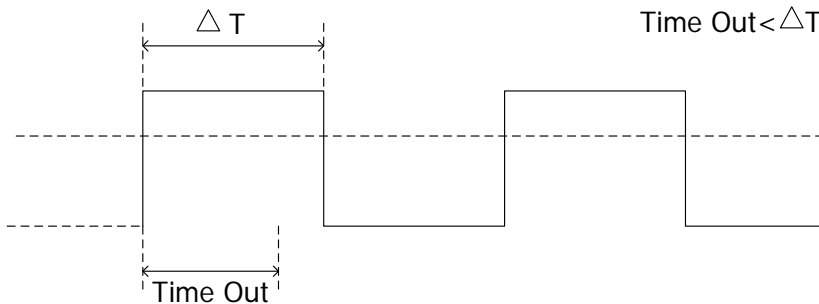

Trigger Type:

Press **Type** to select "TimeOut". At this point, the trigger setting information as shown in the figure below is displayed at the upper right corner of the screen.





Source Selection:

Press **Source** to select CH1-CH4 as the [Trigger Source](#). The current trigger source is displayed at the upper right corner of the screen.

Note: select channel with signal input as trigger source to obtain stable trigger.

Edge Type:

Press **Slope** to select the type of the first edge of the input signal that passes through the trigger level.

- : start timing when the rising edge of the input signal passes through the trigger level.
- : start timing when the falling edge of the input signal passes through the trigger level.
- : start timing when any edge of the input signal passes through the trigger level.

Timeout Time:

Press **TimeOut** to set the timeout time of timeout trigger and the range is from 16 ns to 10 s.

Trigger Mode:

Press **Sweep** to select the [Trigger Mode](#) (page [5-3](#)) under this trigger type as auto, normal or single. The corresponding status light of the current trigger mode turns on.

Trigger Setting:

Press **Setting** to set the trigger parameters (trigger holdoff and noise rejection) under this trigger type.

Trigger Level:

Use **TRIGGER**  **LEVEL** to modify the level. For details, please refer to the description of "[Trigger Level](#)" on page [5-9](#).

Runt Trigger (Option)

This trigger mode is used to trigger pulses that pass through one trigger level but fails to pass through the other trigger level as shown in the figure below.

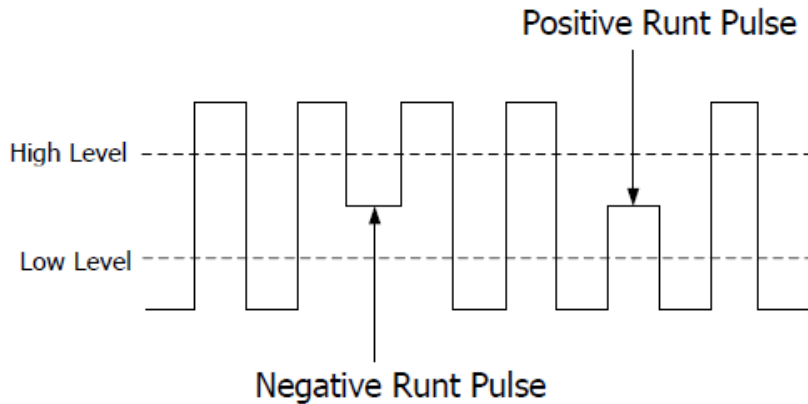

Trigger Type:

Press **Type** to select "Runt". At this point, the trigger setting information as shown in the figure below is displayed at the upper right corner of the screen.





Source Selection:

Press **Source** to select CH1-CH4 as the [Trigger Source](#). The current trigger source is displayed at the upper right corner of the screen.

Pulse Polarity:

Press **Polarity** to select the pulse polarity of runt trigger.

- : positive polarity. The instrument triggers on the positive runt pulse.
- : negative polarity. The instrument triggers on the negative runt pulse.

Qualifier:

Press **Qualifier** to set the trigger conditions of runt trigger.



- **None**: do not set the trigger condition of runt trigger.
- **>**: trigger when the runt pulse width is greater than the lower limit of pulse width. Press **Lower Limit** to set the minimum pulse width of runt trigger. The range available is from 8 ns to 10 s.

- <: trigger when the runt pulse width is lower than the upper limit of pulse width. Press **Upper Limit** to set the maximum pulse width of runt trigger. The range available is from 8 ns to 10 s.
- <>: trigger when the runt pulse width is greater than the lower limit and lower than the upper limit of pulse width. Press **Upper Limit** to set the maximum pulse width of runt trigger and the range is from 16 ns to 10 s; press **Lower Limit** to set the minimum pulse width of runt trigger and the range is from 8 ns to 9.99 s.

Note: the lower limit of the pulse width must be lower than the upper limit.



Vertical Window:

Press **Vertical** to select the desired vertical window type. Note that under the “Runt trigger” menu, you can press the trigger level knob continuously to switch among different vertical window types.

You can select the boundary of the trigger level to be set and then use **Trigger**  **LEVEL** to adjust the trigger level. During the adjustment, two orange trigger level lines and trigger marks ( and ) appear on the screen and move up and down with the rotation of the knob. At the same time, the current trigger level values are displayed at the lower left corner of the screen. The trigger level lines and trigger marks disappear after you stop rotating the knob for 2 s.

```
Up Level : 9.30 V
Low Level : -700mV
```

The adjustment mode of the trigger level differs when different vertical window is selected.

- : only adjust the upper limit of the trigger level. During the adjustment, the “Up Level” changes accordingly and “Low Level” remains unchanged.
- : only adjust the lower limit of the trigger level. During the adjustment, the “Low Level” changes accordingly and the “Up Level” remains unchanged.
- : adjust the upper and lower limits of the trigger level at the same time. During the adjustment, the “Up Level” and “Low Level” change accordingly.

Trigger Mode:

Press **Sweep** to select the [Trigger Mode](#) (page 5-3) under this trigger type as auto, normal or single. The corresponding status light of the current trigger mode turns on.

Trigger Setting:

Press **Setting** to set the trigger parameters (trigger holdoff and noise rejection) under this trigger type.

Windows Trigger (Option)

Windows trigger provides a high trigger level and a low trigger level. The instrument triggers when the input signal passes through the high trigger level or the low trigger level.

Trigger Type:

Press **Type** to select "Windows". At this point, the trigger setting information as shown in the figure below is displayed at the upper right corner of the screen.





Source Selection:

Press **Source** to select CH1-CH4 as the [Trigger Source](#). The current trigger source is displayed at the upper right corner of the screen.

Note: select channel with signal input as trigger source to obtain stable trigger.

Windows Type:

Press **WndType** to select the kind of edge of the input signal on which the oscilloscope triggers.

- : trigger on the rising edge of the input signal when the voltage level is greater than the preset high trigger level.
- : trigger on the falling edge of the input signal when the voltage level is lower than the preset low trigger level.
- : trigger on any edge of the input signal when the voltage level meets the preset trigger level.

Trigger Position:

After selecting the windows type, press **Position** to further specify the time point of trigger by selecting the trigger position.

- **Enter**: trigger when the trigger signal enters the specified trigger level range.
- **Exit**: trigger when the input signal exits the specified trigger level range.
- **Time**: used to specify the hold time of the input signal after entering the specified trigger level range. The instrument triggers when the accumulated hold time equals the windows time.

Vertical Window:

Press **Vertical** to select the desired vertical window type. For detailed operation, refer to "[Vertical Window](#)" on page [5-26](#).

Trigger Mode:

Press **Sweep** to select the [Trigger Mode](#) (page [5-3](#)) under this trigger type as auto, normal or single. The corresponding status light of the current trigger mode turns on.

Trigger Setting:

Press **Setting** to set the trigger parameters (trigger holdoff and noise rejection) under this trigger type.

Delay Trigger (Option)

Trigger when the time difference (ΔT) between the specified edges of source A and source B meets the preset time limit, as shown in the figure below. Note that edge A and edge B must be neighbouring edges.

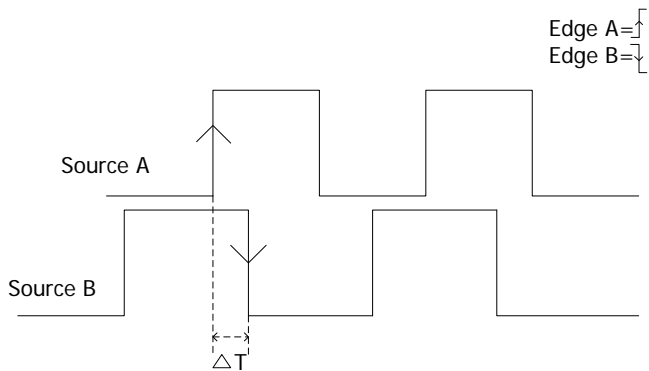

Trigger Type:

Press **Type** to select "Delay". At this point, the trigger setting information as shown in the figure below is displayed at the upper right corner of the screen.



Source A:

Press **SourceA** to select CH1-CH4 as the trigger source of signal source A.

Edge A:

Press **EdgeA** to select the trigger edge type of signal source A in delay trigger. It can be set to the rising edge or falling edge.

Source B:

Press **SourceB** to select CH1-CH4 as the trigger source of signal source B.

Edge B:

Press **EdgeB** to select the trigger edge type of signal source B in delay trigger. It can be set to the rising edge or falling edge.

Delay Type:

Press **DelayType** to set the time limit condition of delay trigger.

- **>**: trigger when the time difference (ΔT) between the specified edges of source A and source B is greater than the preset time limit. Press **Time** to set the delay time in delay trigger and the range is from 8 ns to 10 s.
- **<**: trigger when the time difference (ΔT) between the specified edges of source A and source B is lower than the preset time limit. Press **Time** to set the delay time in delay trigger and the range is from 8 ns to 10 s.
- **<>**: trigger when the time difference (ΔT) between the specified edges of source A and source B is greater than the lower limit of the preset time and lower than the upper limit of the preset time. Press **Upper Limit** to set the upper limit of the delay time in delay trigger and the range is from 16 ns to 10 s. Press **Lower Limit** to set the lower limit of the delay time in delay trigger and the range is from 8 ns to 9.99 s. Note that the time lower limit must be lower than the time upper limit.
- **><**: trigger when the time difference (ΔT) between the specified edges of source A and source B is lower than the lower limit of the preset time or greater than the upper limit of the preset time. Press **Upper Limit** to set the upper limit of the delay time in delay trigger and the range is from 16 ns to 10 s. Press **Lower Limit** to set the lower limit of the delay time in delay trigger and the range is from 8 ns to 9.99 s. Note that the time lower limit must be lower than the time upper limit.

Trigger Mode:

Press **Sweep** to select the [Trigger Mode](#) (page [5-3](#)) under this trigger type as auto, normal or single. The corresponding status light of the current trigger mode turns on.

Trigger Setting:

Press **Setting** to set the trigger parameters (trigger holdoff and noise rejection) under this trigger type.

Trigger Level:

Use **TRIGGER**  **LEVEL** to modify the level. For details, please refer to the description of "[Trigger Level](#)" on page [5-9](#).

Nth Edge Trigger (Option)

Trigger on the nth edge that appears after the specified idle time, as shown in the figure below.

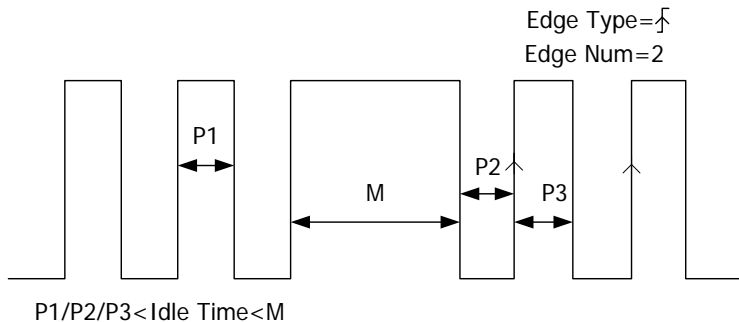

Trigger Type:

Press **Type** to select “Nth Edge”. At this point, the trigger setting information as shown in the figure below is displayed at the upper right corner of the screen.



Source Selection:

Press **Source** to select CH1-CH4 as the [Trigger Source](#). The current trigger source is displayed at the upper right corner of the screen.
Note: select channel with signal input as trigger source to obtain stable trigger.

Edge Type:

Press **Slope** to select the kind of edge of the input signal on which the oscilloscope triggers.

- : trigger on the rising edge of the input signal when the voltage level meets the specified trigger level.
- : trigger on the falling edge of the input signal when the voltage level meets the specified trigger level.

Idle Time:

Press **Idle** to set the idle time before the edge counting in Nth edge trigger. The range available is from 16 ns to 10 s.

Edge Number:

Press **Edge** to set the value of “N” in Nth edge trigger and the range available is from 1 to 65535.

Trigger Mode:

Press **Sweep** to select the [Trigger Mode](#) (page [5-3](#)) under this trigger type as auto, normal or single. The corresponding status light of the current trigger mode turns on.

Trigger Setting:

Press **Setting** to set the trigger parameter (noise rejection) under this trigger type.

Trigger Level:

Use **TRIGGER**  **LEVEL** to modify the level. For details, please refer to the description of “[Trigger Level](#)” on page [5-9](#).

RS232 Trigger (Option)

Trigger according to the start frame, error frame, check error or data. Below is the explanatory figure of RS232 protocol.

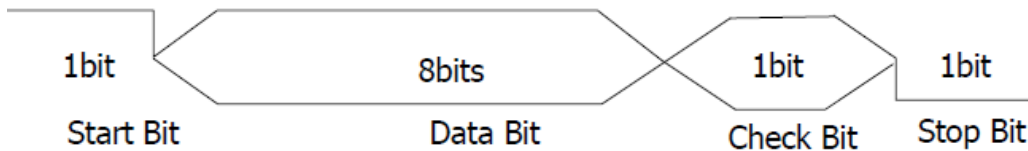

Trigger Type:

Press **Type** to select "RS232". At this point, the trigger setting information as shown in the figure below is displayed at the upper right corner of the screen.

T 232 1 0.00V

Source Selection:

Press **Source** to select CH1-CH4 as the [Trigger Source](#). The current trigger source is displayed at the upper right corner of the screen.

Polarity

Press **Polarity** to select the polarity of data transmission. It can be set to "Normal" or "Invert" and the default is normal.

Trigger Condition:

Press **When** to select the desired trigger condition.

- Start: trigger on the start frame position.
- Error: trigger when error frame is detected. After this trigger condition is selected:
 - press **Stop Bit** to select "1 bit" or "2 bit";
 - press **Even-OddCheck** to select "None", "Odd Checkout" or "Even Checkout".
 The oscilloscope will determine error frame according to the preset parameters.
- Check Error: trigger when check error is detected. When this trigger condition is selected, press **Even-OddCheck** to select "Odd Checkout" or "Even Checkout". The oscilloscope will determine check error according to the preset parameters.
- Data: trigger on the last bit of the preset data bits and even-odd check bits. When this trigger condition is selected:

- press **Data Bits** to select "5 bits", "6 bits", "7 bits" or "8 bits";
- press **Data** and input the data value according to the setting in **Data Bits** and the upper limits are 31, 63, 127 and 255 respectively.

Baud Rate:

Set the baud rate of data transmission (equal to specifying a clock frequency). Press **Baud** to set the desired baud rate to 2400 (default), 4800, 9600, 19200, 38400, 57600, 115200 and user-defined, the default unit is bps. When "User" is selected, press **Setup** and use  to set a more specific value from 1 to 900000 with an adjustment step of 1 bps.

Trigger Mode:

Press **Sweep** to select the [Trigger Mode](#) (page [5-3](#)) under this trigger type as auto, normal or single. The corresponding status light of the current trigger mode turns on.

Trigger Setting:

Press **Setting** to set the trigger parameter (noise rejection) under this trigger type.

Trigger Level:

Use **TRIGGER**  **LEVEL** to modify the level. For details, please refer to the description of "[Trigger Level](#)" on page [5-9](#).

I2C Trigger (Option)

Trigger on the start condition, restart, stop, missing acknowledgement or on the read/write frame with specific device address and data value. In I2C trigger, you need to specify the SCL and SDA data sources. The figure below shows the complete data transmission of I2C bus.

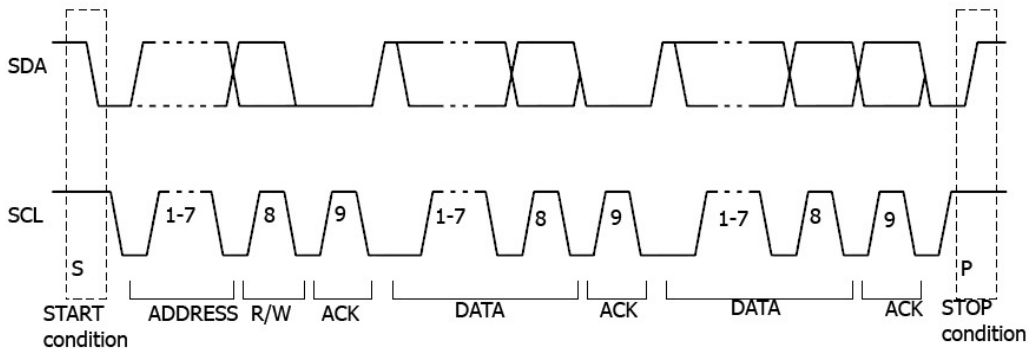

Trigger Type:

Press **Type** to select "I2C". At this point, the trigger setting information as shown in the figure below is displayed at the upper right corner of the screen.



Source Selection:

Press **SCL** and **SDA** to specify the data sources of SCL and SDA respectively. They can be set to CH1-CH4 and the current trigger source is displayed at the upper right corner of the screen.

Trigger Condition:

Press **When** to select the desired trigger condition.

- Start: trigger when SDA data transitions from high to low while SCL is high.
- Restart: trigger when another start condition occurs before a stop condition.
- Stop: trigger when SDA data transitions from low to high while SCL is high.
- Missing ACK: trigger when the SDA data is high during any acknowledgement of SCL clock position.
- Address: trigger on the clock (SCL) edge corresponding to the byte of data (SDA)

behind the preset address (Write, Read or R/W direction). After this trigger condition is selected:

--press **AddrBits** to select "7 bits", "8 bits" or "10 bits";

--press **Address** to set the address value according to the setting in **AddrBits** and the ranges are from 0x0 to 0x7F, 0x0 to 0xFF and 0x0 to 0x3FF respectively;

--press **Direction** to select "Read", "Write" or "R/W" (note: when **AddrBits** is set to "8 bits", this setting is not available).

- **Data:** the trigger searches for the control byte value on the data line (SDA) following which there is a reading bit and an acknowledgement bit and then searches for the specified data value. When this event occurs, the oscilloscope will trigger on the clock edge of the acknowledgement bit behind the data byte. After this trigger condition is selected:

--press **Byte Length** to set the length of the data and the range is from 1 to 5;

--press **CurrentBit** to select the desired data bit and the range is from 0 to (Byte Length×8-1);

--press **Data** to set the data pattern of the current data bit to X, H or L.

--press **AllBits** to set the data pattern of all the data bits to the data pattern specified in **Data**.

- **A&D:** trigger when the "Address" and "Data" conditions are met at the same time. After this trigger condition is selected:

--press **AddrBits** to select "7 bits" , "8 bits" or "10 bits";

--press **Address** to set the address value according to the setting in **AddrBits** and the ranges are from 0x0 to 0x7F, 0x0 to 0xFF and 0x0 to 0x3FF respectively;

--press **Byte Length** to set the length of the data and the range is from 1 to 5;

--press **CurrentBit** to select the desired data bit and the range is from 0 to (Byte Length×8-1);

--press **Data** to set the data pattern of the current data bit to X, H or L.

--press **AllBits** to set the data pattern of all the data bits to the data pattern specified in **Data**.

--press **Direction** to select "Read", "Write" or "R/W" (note: when **AddrBits** is set to "8 bit", this setting is not available).

Trigger Mode:

Press **Sweep** to select the **Trigger Mode** (page [5-3](#)) under this trigger type as auto, normal or single. The corresponding status light of the current trigger mode turns on.

Trigger Setting:

Press **Setting** to set the trigger parameter (noise rejection) under this trigger type.

Trigger Level:

Use **TRIGGER  LEVEL** to modify the trigger level of SCL or SDA channel. For details, please refer to the description of "[Trigger Level](#)" on page [5-9](#).

SPI Trigger (Option)

Trigger on the data pattern on the specified edge. When using SPI trigger, you need to specify the SCL and SDA data sources. Below is the sequence chart of SPI bus data transmission.

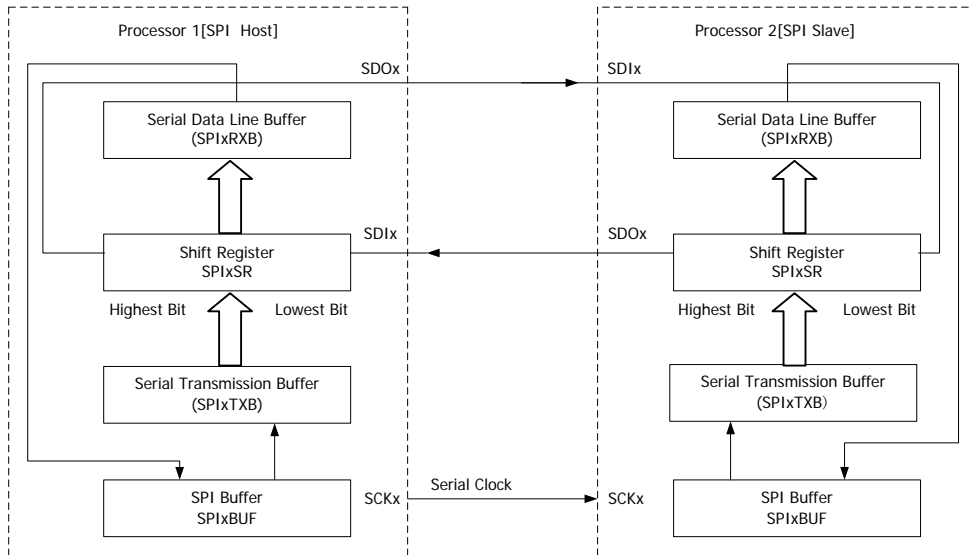

Trigger Type:

Press **Type** to select "SPI". At this point, the trigger setting information as shown in the figure below is displayed at the upper right corner of the screen.





Source Selection:

Press **SCL** and **SDA** to specify the data sources of SCL and SDA respectively. They can be set to CH1-CH4 and the current trigger source is displayed at the upper right corner of the screen.

Trigger Condition:

Press **When** to select the desired trigger condition.

- CS: trigger when the CS channel is select high level or low level. After this trigger condition is selected, press **Mode** to select  or . Note

that **CS** is valid only when this condition is selected.

- **TimeOut**: set the minimum time that the clock (SCL) signal must be idle before the oscilloscope starts to search for the data (SDA) on which to trigger. Press **TimeOut** to set the timeout value and the range is from 100 ns to 1 s. Note that, at this point, **CS** is invalid (not displayed).



Data Line Setting:

Set the instrument to trigger when the specified bit and length of data is transmitted in the SDA.

- Press **Data Bits** to set the number of bits of the serial data character string. It can be set to any integer between 4 and 32.
- Press **CurrentBit** to set the number of the data bit and the range is from 0 to (value sepecified in **Data Bits** – 1).
- Press **Data** to set the value of the current bit to H, L or X.
- Press **AllBits** to set all the data bits to the value specified in **Data**.

Clock Edge:

Press **Clock Edge** to select the desired clock edge.

- : sample the SDA data on the rising edge of the clock.
- : sample the SDA data on the falling edge of the clock.

Trigger Mode:

Press **Sweep** to select the **Trigger Mode** (page [5-3](#)) under this trigger type as auto, normal or single. The corresponding status light of the current trigger mode turns on.

Trigger Setting:

Press **Setting** to set the trigger parameter (noise rejection) under this trigger type.

Trigger Level:

Use **TRIGGER**  **LEVEL** to modify the level. For details, please refer to the description of "[Trigger Level](#)" on page [5-9](#).

Trigger Output Connector

The trigger output connector at the rear panel can output trigger signals determined by the current setting.

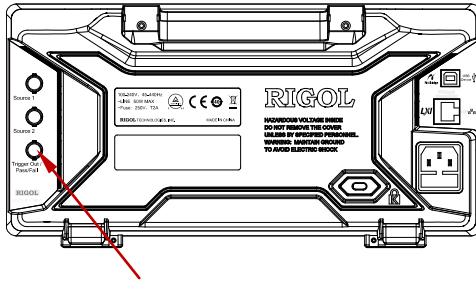

Trigger Output Connector

When the oscilloscope is triggered, a signal that can reflect the current capture rate of the oscilloscope will be outputted via **[Trigger Out]** connector and connect the signal to a waveform display instrument to measure the frequency of the signal and the result is equal to the current capture rate.

Note: in the **9 Pass/Fail** Test, when the **Aux Out** is turned on, there will be output a negative pulse signal when failed waveforms are detected by the oscilloscope. Connect this signal to other control systems to view the test result conveniently. There will be output a 3.3 V CMOS high level when no failed waveform is detected by the oscilloscope.

Chapter 6 To Make Measurements

DS1000Z can make math operation, cursor measurement and auto measurement on sampled and displayed data.

The contents of this chapter:

- [Math Operation](#)
- [Auto Measurement](#)
- [Cursor Measurement](#)

Math Operation





DS1000Z can realize various math operations (including: addition (A+B), subtraction (A-B), multiplication (AxB), division (A÷B), FFT, A&&B, A||B, A^B, !A, intg, diff, sqrt, lg, ln, exp and abs. The results of math operation also allows further measurement (for details, please refer to "[Cursor Measurement](#)").

Press **MATH** → **Math** → **Operator** in the vertical control area (VERTICAL) at the front panel to select the desired operator. The result of math operation will be displayed on the waveform marked with "M" on the screen after the operation was enabled.

Addition

Add the waveform voltage values of signal source A and B point by point and display the results.



Press **MATH** → **Math** → **Operator** to select "A+B":

- Press **Display** to turn on or off the addition operation function.
- Press **Source A** and **Source B** to select the desired channels (CH1, CH2, CH3 or CH4).
- Press **Offset** and use  to adjust the vertical offset of the operation result.
- Press **Scale** and use  to adjust the vertical scale of the operation results.
- Press **Scale Reset**, the instrument will adjust the vertical scale to the best value according to the current configuration automatically.
- Press **Options** to set the start point, end point or turn on or off the inverted display of the operation results.
 - Press **Start** to set the start point of the operation results.
 - Press **End** to set the end point of the operation results.
 - Press **Invert** to turn the inverted display of the operation results on or off.
 - Press **Auto Scale** to turn on or off the auto scale function. When "ON" is selected, the instrument will adjust the vertical scale to the best value according to the current configuration automatically.
- **HORIZONTAL**  **POSITION** and **HORIZONTAL**  **SCALE** can also be used to adjust the horizontal position and scale of the operation results.

Substraction

Subtract the waveform voltage values of signal source B from that of source A point by point and display the results.

Press **MATH** → **Math** → **Operator** to select "A-B":



- Press **Display** to turn on or off the subtraction operation function.
- Press **Source A** and **Source B** to select the desired channels (CH1, CH2, CH3 or CH4).
- Press **Offset** and use  to adjust the vertical offset of the operation result.
- Press **Scale** and use  to adjust the vertical scale of the operation results.
- Press **Scale Reset**, the instrument will adjust the vertical scale to the best value according to the current configuration automatically.
- Press **Options** to set the start point, end point or turn on or off the inverted display of the operation results.

Press **Start** to set the start point of the operation results.

Press **End** to set the end point of the operation results.

Press **Invert** to turn the inverted display of the operation results on or off.

Press **Auto Scale** to turn on or off the auto scale function. When "ON" is selected, the instrument will adjust the vertical scale to the best value according to the current configuration automatically.



- **HORIZONTAL**  **POSITION** and **HORIZONTAL**  **SCALE** can also be used to adjust the horizontal position and scale of the operation results.

Multiplication

Multiply the waveform voltage values of signal source A and B point by point and display the results.

Press **MATH** → **Math** → **Operator** to select "A×B":



- Press **Display** to turn on or off the multiplication operation function.
- Press **Source A** and **Source B** to select the desired channels (CH1, CH2, CH3 or CH4).
- Press **Offset** and use  to adjust the vertical offset of the operation result.

- Press **Scale** and use  to adjust the vertical scale of the operation results.
- Press **Scale Reset**, the instrument will adjust the vertical scale to the best value according to the current configuration automatically.
- Press **Options** to set the start point, end point or turn on or off the inverted display of the operation results.
Press **Start** to set the start point of the operation results.
Press **End** to set the end point of the operation results.
Press **Invert** to turn the inverted display of the operation results on or off.
Press **Auto Scale** to turn on or off the auto scale function. When "ON" is selected, the instrument will adjust the vertical scale to the best value according to the current configuration automatically.
- **HORIZONTAL**  **POSITION** and **HORIZONTAL**  **SCALE** can also be used to adjust the horizontal position and scale of the operation results.



Division

Divide the waveform voltage values of signal source A by that of source B point by point and display the results. It can be used to analyze the multiple relationships of waveforms in two channels. Note that when the voltage value of channel B is 0, the result of the division is treated as 0.

Press **MATH** → **Math** → **Operator** to select "A÷B":

- Press **Display** to turn on or off the division operation function.
- Press **Source A** and **Source B** to select the desired channels (CH1, CH2, CH3 or CH4).
- Press **Offset** and use  to adjust the vertical offset of the operation result.
- Press **Scale** and use  to adjust the vertical scale of the operation results.
- Press **Scale Reset**, the instrument will adjust the vertical scale to the best value according to the current configuration automatically.
- Press **Options** to set the start point, end point or turn on or off the inverted display of the operation results.
Press **Start** to set the start point of the operation results.
Press **End** to set the end point of the operation results.
Press **Invert** to turn the inverted display of the operation results on or off.
Press **Auto Scale** to turn on or off the auto scale function. When "ON" is

selected, the instrument will adjust the vertical scale to the best value according to the current configuration automatically.

- **HORIZONTAL  POSITION** and **HORIZONTAL  SCALE** can also be used to adjust the horizontal position and scale of the operation results.

FFT

FFT is used to quickly perform Fourier transform on specified signals and transform time domain signals to frequency domain signals. FFT operation can facilitate the following works:

- Measure harmonic components and distortion in the system
- Measure the characteristics of the noise in DC power
- Analyze vibration

Press **MATH** → **Math** → **Operator** to select “FFT” and set the parameters of FFT operation.

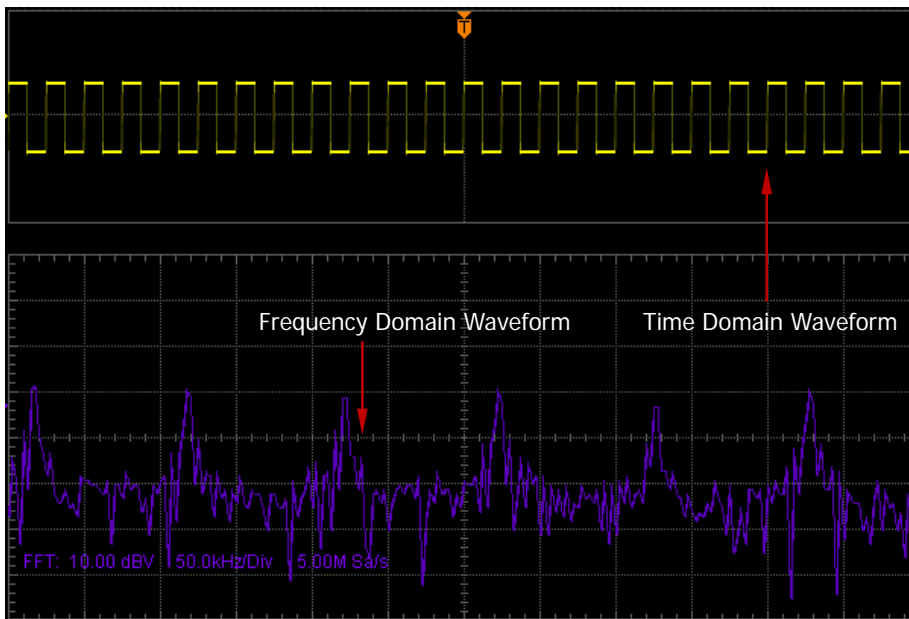

1. Operation

Press **Display** to enable or disable the FFT operation function.

2. Select Source

Press **Source** to select the desired channel (CH1, CH2, CH3 or CH4).

3. Vertical Offset

Press **Offset** and use  to adjust the vertical offset of the operation result.

4. Vertical Scale

Press **Scale** and use  to adjust the vertical scale of the operation results.

5. Center Frequency

Press **Center** to adjust the frequency of frequency domain waveform relative to the horizontal center of screen.

6. Horizontal Scale

Press **Scale** and use  to adjust the horizontal scale of frequency domain waveform.

7. Select Window Function

Spectral leakage can be considerably decreased when a window function is used. DS1000Z provides four kinds of FFT window functions which have different characteristics and are applicable to measure different waveforms. You need to select the window function according to different waveforms and their characteristics. Press **Window** to select the desired window function and the default is "Rectangle".

Table 0-1 Window Functions

Window	Characteristics	Waveforms Suitable for Measurement
Rectangle	The best frequency resolution; the poorest amplitude resolution; similar to the situation when no window is multiplied.	Transient or short pulse, the signal levels before and after the multiplication are basically the same; Sine waveforms with the same amplitude and rather similar frequencies; Wide band random noise with relatively slowly changing waveform spectrum.
Hanning	Better frequency resolution; poorer amplitude resolution.	Sine, periodic and narrow band random noise.
Hamming	A little bit better frequency resolution than Hanning	Transient or short pulse, the signal levels before and after the multiplication are rather different.

Blackman	The best amplitude resolution; the poorest frequency resolution	Single frequency signal, search for higher order harmonics.
Flattop	Measure signal precisely.	The signal that no accurate reference but require accurate measurements
Triangle	Better frequency resolution.	Narrowband signal with strong interference noise.

8. Set the view Mode

Press **View** to select "Half" (default) or "Full" display mode.

Half: the source channel and the FFT operation results are displayed separately.

The time domain and frequency domain signals are displayed clearly.

Full Screen: the source channel and the FFT operation results are displayed in the same window to view the frequency spectrum more clearly and to perform more precise measurement.

Note: in FFT mode and when MATH is the active channel, you can also press **HORIZONTAL**  **SCALE** to switch between "Half" and "Full".

9. Set the Vertical Scale

The unit of the vertical axis can be dB/dBm or Vrms which use logarithmic mode and linear mode to display vertical amplitude respectively. If you need to display the FFT frequency spectrum in a relatively larger dynamic range, dB/dBm is recommended. Press **Unit** to select the desired unit and the default is Vrms.

10. Press **Scale Reset**, the instrument will adjust the vertical scale to the best value according to the current configuration automatically.

Tips

Signals with DC components or deviation would cause error or deviation of the FFT waveform components. To reduce the DC components, set the "**Channel Coupling**" to "AC".

To reduce the random noise and aliasing frequency components of repetitive or single pulse, set the "**Acquisition Mode**" of the oscilloscope to "Average".





“AND” Operation

Perform logic operation on specified sources waveform point by point and display the results. In operation, when the voltage value of the source channel is greater than the threshold of the corresponding channel, it is regarded as logic “1”; otherwise logic “0”. The following common logic operation expressions are provided.

The results of logic “AND” operation of two binary bits are as follows:

A	B	A&&B
0	0	0
0	1	0
1	0	0
1	1	1

Press **MATH** → **Math** → **Operator** to select “A&&B”:

- Press **Display** to turn on or off the AND operation function.
- Press **Source A** and **Source B** to select the desired channels (CH1, CH2, CH3 or CH4).
- Press **Offset** and use  to adjust the vertical offset of the operation result.
- Press **Scale** and use  to adjust the vertical scale of the operation results.
- Press **Scale Reset**, the instrument will adjust the vertical scale to the best value according to the current configuration automatically.
- Press **Tre.A** and use  to set the threshold of source A in logic operation.
- Press **Tre.B** and use  to set the threshold of source B in logic operation.
- Press **Options** to set the start point, end point or turn on or off the inverted display of the operation results.



Press **Start** to set the start point of the operation results.

Press **End** to set the end point of the operation results.

Press **Invert** to turn the inverted display of the operation results on or off.

Press **Sens.** to set the sensitivity of the operation results and the range available is 0 div to 0.96 div.

Press **Auto Scale** to turn on or off the auto scale function. When “ON” is selected, the instrument will adjust the vertical scale to the best value according to the current configuration automatically.

- **HORIZONTAL**  **POSITION** and **HORIZONTAL**  **SCALE** can also be used to adjust the horizontal position and scale of the operation results.





“OR” Operation

Perform logic operation on specified sources waveform point by point and display the results. In operation, when the voltage value of the source channel is greater than the threshold of the corresponding channel, it is regarded as logic “1”; otherwise logic “0”. The following common logic operation expressions are provided.

The results of logic “OR” operation of two binary bits are as follows:

A	B	A B
0	0	0
0	1	1
1	0	1
1	1	1

Press **MATH** → **Math** → **Operator** to select “A||B”:

- Press **Display** to turn on or off the OR operation function.
- Press **Source A** and **Source B** to select the desired channels (CH1, CH2, CH3 or CH4).
- Press **Offset** and use  to adjust the vertical offset of the operation result.
- Press **Scale** and use  to adjust the vertical scale of the operation results.
- Press **Scale Reset**, the instrument will adjust the vertical scale to the best value according to the current configuration automatically.
- Press **Tre.A** and use  to set the threshold of source A in logic operation.
- Press **Tre.B** and use  to set the threshold of source B in logic operation.
- Press **Options** to set the start point, end point or turn on or off the inverted display of the operation results.



Press **Start** to set the start point of the operation results.

Press **End** to set the end point of the operation results.

Press **Invert** to turn the inverted display of the operation results on or off.

Press **Sens.** to set the sensitivity of the operation results and the range available is 0 div to 0.96 div.

Press **Auto Scale** to turn on or off the auto scale function. When “ON” is selected, the instrument will adjust the vertical scale to the best value according to the current configuration automatically.

- **HORIZONTAL**  **POSITION** and **HORIZONTAL**  **SCALE** can also be used to adjust the horizontal position and scale of the operation results.





“XOR” Operation

Perform logic operation on specified sources waveform point by point and display the results. In operation, when the voltage value of the source channel is greater than the threshold of the corresponding channel, it is regarded as logic “1”; otherwise logic “0”. The following common logic operation expressions are provided.

The results of logic “XOR” operation of two binary bits are as follows:

A	B	A^B
0	0	0
0	1	1
1	0	1
1	1	0

Press **MATH** → **Math** → **Operator** to select “A^B”:

- Press **Display** to turn on or off the XOR operation function.
- Press **Source A** and **Source B** to select the desired channels (CH1, CH2, CH3 or CH4).
- Press **Offset** and use  to adjust the vertical offset of the operation result.
- Press **Scale** and use  to adjust the vertical scale of the operation results.
- Press **Scale Reset**, the instrument will adjust the vertical scale to the best value according to the current configuration automatically.
- Press **Tre.A** and use  to set the threshold of source A in logic operation.
- Press **Tre.B** and use  to set the threshold of source B in logic operation.
- Press **Options** to set the start point, end point or turn on or off the inverted display of the operation results.



Press **Start** to set the start point of the operation results.

Press **End** to set the end point of the operation results.

Press **Invert** to turn the inverted display of the operation results on or off.

Press **Sens.** to set the sensitivity of the operation results and the range available is 0 div to 0.96 div.

Press **Auto Scale** to turn on or off the auto scale function. When “ON” is selected, the instrument will adjust the vertical scale to the best value according to the current configuration automatically.

- **HORIZONTAL**  **POSITION** and **HORIZONTAL**  **SCALE** can also be used to adjust the horizontal position and scale of the operation results.



“NOT” Operation

Perform logic operation on specified sources waveform point by point and display the results. In operation, when the voltage value of the source channel is greater than the threshold of the corresponding channel, it is regarded as logic “1”; otherwise logic “0”. The following common logic operation expressions are provided.

The results of logic **NOT** operation of a binary bit are as follows:

A	!A
0	1
1	0

Press **MATH** → **Math** → **Operator** to select “!A”:

- Press **Display** to turn on or off the NOT operation function.
- Press **Source A** and **Source B** to select the desired channels (CH1, CH2, CH3 or CH4).
- Press **Offset** and use  to adjust the vertical offset of the operation result.
- Press **Scale** and use  to adjust the vertical scale of the operation results.
- Press **Scale Reset**, the instrument will adjust the vertical scale to the best value according to the current configuration automatically.
- Press **Tre.A** and use  to set the threshold of source A in logic operation.
- Press **Options** to set the start point, end point or turn on or off the inverted display of the operation results.



Press **Start** to set the start point of the operation results.

Press **End** to set the end point of the operation results.

Press **Invert** to turn the inverted display of the operation results on or off.

Press **Sens.** to set the sensitivity of the operation results and the range available is 0 div to 0.96 div.



Press **Auto Scale** to turn on or off the auto scale function. When “ON” is selected, the instrument will adjust the vertical scale to the best value according to the current configuration automatically.

- **HORIZONTAL**  **POSITION** and **HORIZONTAL**  **SCALE** can also be used to adjust the horizontal position and scale of the operation results.

Integrate

Calculate the integral of the specified signal source. For example, you can use integrate to calculate the energy of a pulse or measure the area under a waveform.

Press **MATH** → **Math** → **Operator** to select "intg":



- Press **Display** to turn on or off the integral operation function.
- Press **Source** to select the desired channels (CH1, CH2, CH3 or CH4).
- Press **Offset** and use  to adjust the vertical offset of the operation result.
- Press **Scale** and use  to adjust the vertical scale of the operation results.
- Press **Scale Reset**, the instrument will adjust the vertical scale to the best value according to the current configuration automatically.
- Press **Options** to set the start point, end point or turn on or off the inverted display of the operation results.

Press **Start** to set the start point of the operation results.

Press **End** to set the end point of the operation results.

Press **Invert** to turn the inverted display of the operation results on or off.



Press **Auto Scale** to turn on or off the auto scale function. When "ON" is selected, the instrument will adjust the vertical scale to the best value according to the current configuration automatically.

- **HORIZONTAL**  **POSITION** and **HORIZONTAL**  **SCALE** can also be used to adjust the horizontal position and scale of the operation results.

Differentiate

Calculate the derivative of the specified signal source. For example, you can use differentiate to calculate the instantaneous slope of a waveform.

Press **MATH** → **Math** → **Operator** to select "diff":

- Press **Display** to turn on or off the derivative operation function.
- Press **Source** to select the desired channels (CH1, CH2, CH3 or CH4).
- Press **Offset** and use  to adjust the vertical offset of the operation result.
- Press **Scale** and use  to adjust the vertical scale of the operation results.
- Press **Scale Reset**, the instrument will adjust the vertical scale to the best value according to the current configuration automatically.
- Press **Options** to set the start point, end point or turn on or off the inverted display of the operation results.



Press **Start** to set the start point of the operation results.

Press **End** to set the end point of the operation results.

Press **Invert** to turn the inverted display of the operation results on or off.

Press **Diff.Bias** to set the derivative bias of the operation results and the range available is 1 to 50.

Press **Auto Scale** to turn on or off the auto scale function. When "ON" is selected, the instrument will adjust the vertical scale to the best value according to the current configuration automatically.

- **HORIZONTAL**  **POSITION** and **HORIZONTAL**  **SCALE** can also be used to adjust the horizontal position and scale of the operation results.



Tip

Because differentiation is very sensitive to noise, so you can set the [Acquisition Mode](#) to "Average".

Square Root

Calculate the square root of specified signal source point by point and display the results.

Press **MATH** → **Math** → **Operator** to select "sqrt":



- Press **Display** to turn on or off the square root operation function.
- Press **Source** to select the desired channels (CH1, CH2, CH3 or CH4).
- Press **Offset** and use  to adjust the vertical offset of the operation result.
- Press **Scale** and use  to adjust the vertical scale of the operation results.
- Press **Scale Reset**, the instrument will adjust the vertical scale to the best value according to the current configuration automatically.
- Press **Options** to set the start point, end point or turn on or off the inverted display of the operation results.

Press **Start** to set the start point of the operation results.

Press **End** to set the end point of the operation results.

Press **Invert** to turn the inverted display of the operation results on or off.



Press **Auto Scale** to turn on or off the auto scale function. When "ON" is selected, the instrument will adjust the vertical scale to the best value according to the current configuration automatically.

- **HORIZONTAL**  **POSITION** and **HORIZONTAL**  **SCALE** can also be used to adjust the horizontal position and scale of the operation results.

Base 10 Logarithm

Calculate the base 10 logarithm of specified signal source point by point and display the results.

Press **MATH** → **Math** → **Operator** to select “lg”:



- Press **Display** to turn on or off the base 10 logarithm operation function.
- Press **Source** to select the desired channels (CH1, CH2, CH3 or CH4).
- Press **Offset** and use  to adjust the vertical offset of the operation result.
- Press **Scale** and use  to adjust the vertical scale of the operation results.
- Press **Scale Reset**, the instrument will adjust the vertical scale to the best value according to the current configuration automatically.
- Press **Options** to set the start point, end point or turn on or off the inverted display of the operation results.

Press **Start** to set the start point of the operation results.

Press **End** to set the end point of the operation results.

Press **Invert** to turn the inverted display of the operation results on or off.



Press **Auto Scale** to turn on or off the auto scale function. When “ON” is selected, the instrument will adjust the vertical scale to the best value according to the current configuration automatically.

- **HORIZONTAL**  **POSITION** and **HORIZONTAL**  **SCALE** can also be used to adjust the horizontal position and scale of the operation results.

Natural Logarithm

Calculate the natural logarithm of specified signal source point by point and display the results.

Press **MATH** → **Math** → **Operator** to select “ln”:

- Press **Display** to turn on or off the natural logarithm operation function.
- Press **Source** to select the desired channels (CH1, CH2, CH3 or CH4).
- Press **Offset** and use  to adjust the vertical offset of the operation result.
- Press **Scale** and use  to adjust the vertical scale of the operation results.
- Press **Scale Reset**, the instrument will adjust the vertical scale to the best value according to the current configuration automatically.
- Press **Options** to set the start point, end point or turn on or off the inverted



display of the operation results.

Press **Start** to set the start point of the operation results.

Press **End** to set the end point of the operation results.

Press **Invert** to turn the inverted display of the operation results on or off.



Press **Auto Scale** to turn on or off the auto scale function. When "ON" is selected, the instrument will adjust the vertical scale to the best value according to the current configuration automatically.

- **HORIZONTAL**  **POSITION** and **HORIZONTAL**  **SCALE** can also be used to adjust the horizontal position and scale of the operation results.

Exponential

Calculate the exponential of specified signal source point by point and display the results.

Press **MATH** → **Math** → **Operator** to select "exp":



- Press **Display** to turn on or off the exponential operation function.
- Press **Source** to select the desired channels (CH1, CH2, CH3 or CH4).
- Press **Offset** and use  to adjust the vertical offset of the operation result.
- Press **Scale** and use  to adjust the vertical scale of the operation results.
- Press **Scale Reset**, the instrument will adjust the vertical scale to the best value according to the current configuration automatically.
- Press **Options** to set the start point, end point or turn on or off the inverted display of the operation results.

Press **Start** to set the start point of the operation results.

Press **End** to set the end point of the operation results.

Press **Invert** to turn the inverted display of the operation results on or off.



Press **Auto Scale** to turn on or off the auto scale function. When "ON" is selected, the instrument will adjust the vertical scale to the best value according to the current configuration automatically.

- **HORIZONTAL**  **POSITION** and **HORIZONTAL**  **SCALE** can also be used to adjust the horizontal position and scale of the operation results.

Absolute Value

Calculate the absolute value of specified signal source point by point and display the results.

Press **MATH** → **Math** → **Operator** to select "abs":



- Press **Display** to turn on or off the absolute value operation function.
- Press **Source** to select the desired channels (CH1, CH2, CH3 or CH4).
- Press **Offset** and use  to adjust the vertical offset of the operation result.
- Press **Scale** and use  to adjust the vertical scale of the operation results.
- Press **Scale Reset**, the instrument will adjust the vertical scale to the best value according to the current configuration automatically.
- Press **Options** to set the start point, end point or turn on or off the inverted display of the operation results.

Press **Start** to set the start point of the operation results.

Press **End** to set the end point of the operation results.

Press **Invert** to turn the inverted display of the operation results on or off.

Press **Auto Scale** to turn on or off the auto scale function. When "ON" is selected, the instrument will adjust the vertical scale to the best value according to the current configuration automatically.

- **HORIZONTAL**  **POSITION** and **HORIZONTAL**  **SCALE** can also be used to adjust the horizontal position and scale of the operation results.

Auto Measurement

DS1000Z provides auto measurements of 24 waveform parameters and the statistics and analysis of the measurement results. What's more, you can also use the frequency counter to realize more precise frequency measurement.

Quick Measurement after **AUTO**

When the oscilloscope is correctly connected and has detected input signal, press **Auto** to enable waveform auto setting function and open the following function menu:

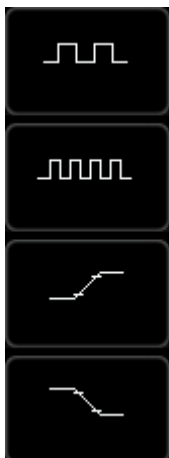

Single-period: measure the "Period" and "Frequency" of the current signal within a single period and display the measurement results at the bottom of the screen.

Multi-period: measure the "Period" and "Frequency" of the current signal within multiple periods and display the measurement results at the bottom of the screen.

Rise Time: measure the "Rise Time" of the current signal and display the measurement result at the bottom of the screen.

Fall Time: measure the "Fall Time" of the current signal and display the measurement result at the bottom of the screen.

Note: the **AUTO** function requires that the frequency of the signal under test should be no lower than 50 Hz, the duty cycle be greater than 1% and the amplitude be at least 20 mVpp. If the parameters of the signal under test exceed these limits, after this softkey is pressed, the quick parameter measurement items might not be displayed in the pop-up menu.

One-key Measurement of 24 Parameters

Press corresponding softkey under the **MENU** at the left of the screen to quickly measure the 24 parameters and realize “One-key” measurement. The measurement result will be displayed at the bottom of the screen.

The icons of time and voltage parameters in the measurement items and the measurement results on the screen are always marked in the same color with the channel (**Measure** → **Source**) currently used. But the delay and phase measurement items are always marked in green. For example,

Note: if the measurement result is displayed as “*****”, it means that there is no signal input in the current source or the measurement result is not within the valid range (too large or too small).

Time Parameters

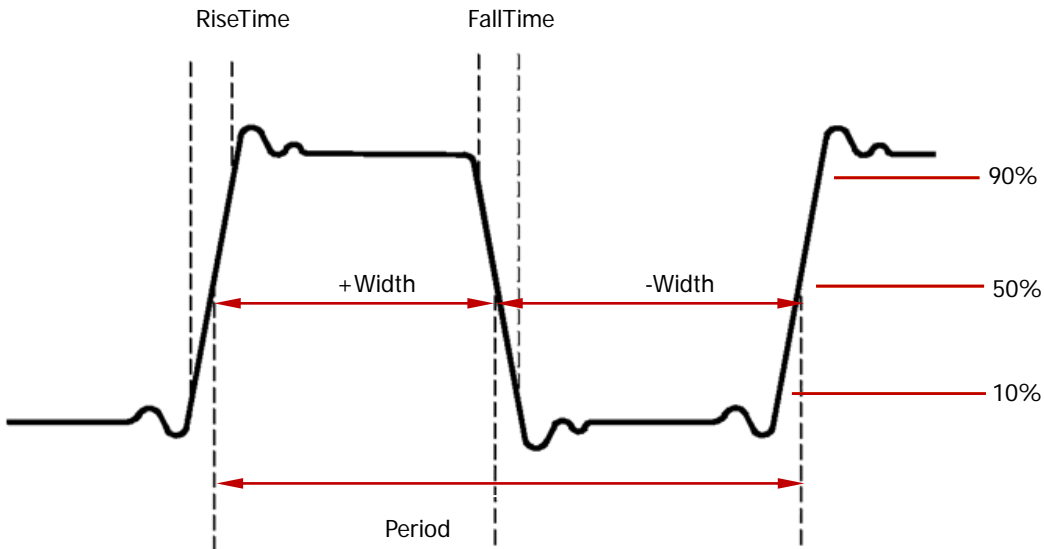

1. **Period**: defined as the time between the middle threshold points of two consecutive, like-polarity edges.
2. **Frequency**: defined as the reciprocal of period.
3. **Rise Time**: the time for the signal amplitude to rise from 10% to 90%.
4. **Fall Time**: the time for the signal amplitude to fall from 90% to 10%.
5. **+ Width**: the time difference between the 50% threshold of a rising edge to the 50% threshold of the next falling edge of the pulse.
6. **- Width**: the time difference between the 50% threshold of a falling edge to the 50% threshold of the next rising edge of the pulse.
7. **+ Duty**: the ratio of the positive pulse width to the period.
8. **- Duty**: the ratio of the negative pulse width to the period.

Delay and Phase

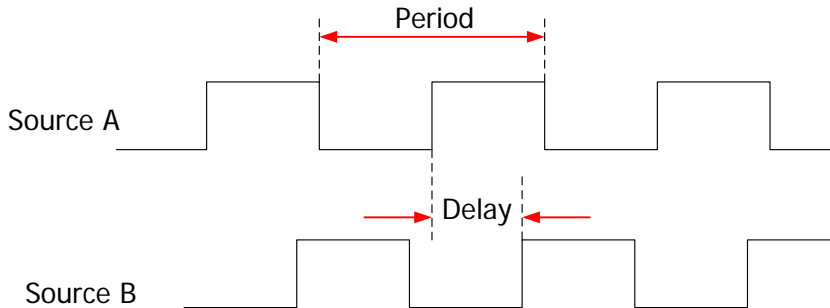

Source A and source B can be CH1 or CH2.

1. **Delay A→B^f**: the time difference between the rising edges of source A and source B. Negative delay indicates that the selected rising edge of source A occurred after the selected edge of source B.
2. **Delay A→B^t**: the time difference between the falling edges of source A and source B. Negative delay indicates that the selected edge of source A occurred after the selected edge of source B.
3. **Phase A→B^f**: phase difference calculated according to "Delay A→B^f" and the period of source A, expressed in degree.
4. **Phase A→B^t**: phase difference calculated according to "Delay A→B^t" and the period of source A, expressed in degree.

$$\text{Phase} = \frac{\text{Delay}}{\text{The Period of Source A}} \times 360^\circ$$

Voltage Parameters

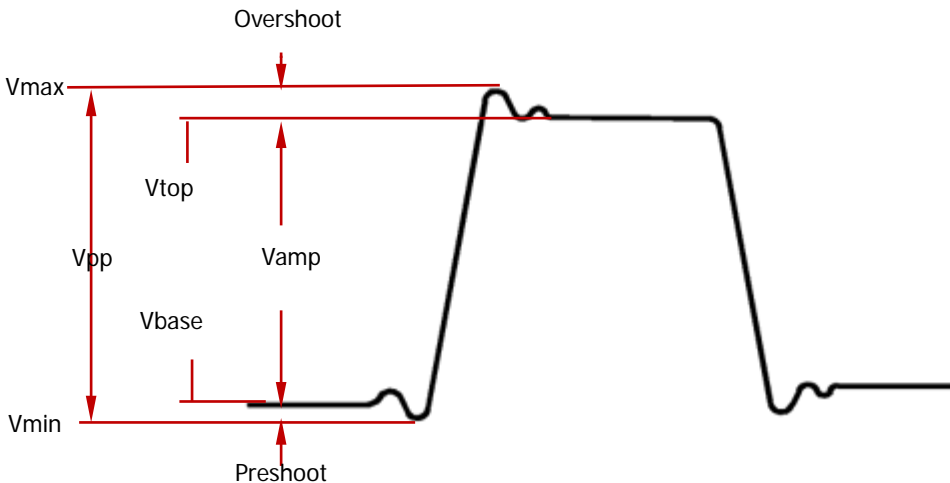

1. **Vmax**: the voltage value from the highest point of the waveform to the GND.
2. **Vmin**: the voltage value from the lowest point of the waveform to the GND.
3. **Vpp**: the voltage value from the highest point to the lowest point of the waveform.
4. **Vtop**: the voltage value from the flat top of the waveform to the GND.
5. **Vbase**: the voltage value from the flat base of the waveform to the GND.
6. **Vamp**: the voltage value from the top of the waveform to the base of the waveform.
7. **Vavg**: the arithmetic average value on the whole waveform or on the gating area.

Average = $\frac{\sum x_i}{n}$, wherein, x_i is the i th point being measured, n is the number of points being measured.

8. **Vrms**: the root mean square value on the whole waveform or the gating area.

RMS = $\sqrt{\frac{\sum_{i=1}^n x_i^2}{n}}$, where, x_i is the i th point being measured, n is the number of points being measured.

9. **Overshoot**: the ratio of the difference of the maximum value and top value of

the waveform to the amplitude value.

- 10. Preshoot:** the ratio of the difference of the minimum value and base value of the waveform to the amplitude value.

Other Parameters

-  **1. Area:** the area of the whole waveform within the screen and the unit is voltage-second. The area measured above the zero reference (namely the vertical offset) is positive and the area measured below the zero reference is negative. The area measured is the algebraic sum of the area of the whole waveform within the screen.

-  **2. Period Area:** the area of the first period of waveform on the screen and the unit is voltage-second. The area above the zero reference (namely the vertical offset) is positive and the area below the zero reference is negative. The area measured is the algebraic sum of the area of the whole period waveform. Note that when the waveform on the screen is less than a period, the period area measured is 0.

Frequency Counter Measurement

The hardware frequency counter supplied with this oscilloscope can make more precise measurement of the input signal frequency.

Press **Measure** → **Counter** to select CH1-CH4 as the measurement source. The measurement result is displayed at the upper right corner of the screen and you can identify the current measurement source according to the color of the icon. The following figure is the result of frequency measurement of the input signal of CH1.



Select "OFF" to disable the frequency counter measurement function.

Measurement Setting

1. Source Selection

Press **Measure** → **Source** to select the desired channel for measurement (CH1-CH4). The color of the parameter icons under **MENU** at the left of the screen will change with the source selected.

2. Delayed Measurement Setting

Specify the source A and source B in the measurement items "**Delay A→B f**" and "**Delay A→B t**".

Press **Measure** → **Setting** → **Type** → "Delay" and then press **SourceA** and **SourceB** to set the two channel sources (CH1-CH4) of delayed measurement respectively.

3. Phase Measurement Setting



Specify the source A and source B in the measurement items "**Phase A→B f**" and "**Phase A→B t**".

Press **Measure** → **Setting** → **Type** → "Phase" and then press **SourceA** and **SourceB** to set the two channel sources (CH1-CH4) of phase measurement respectively.

4. Threshold Measurement Setting

Specify the vertical level (in percentage) being measured in the analog channel. Measurements of all the time, delay and phase parameters will be influenced by this setting.

Press **Measure** → **Setting** → **Type** → "Threshold" and then:

- Press **Max** and use  to set the maximum value of the measurement. Reducing the maximum value to the current "Mid" will automatically reduce the "Mid" to keep it lower than the maximum value. The default is 90% and the range available is from 7% to 95%.
- Press **Mid** and use  to set the middle value of measurement. The middle value is limited by the settings of "Max" and "Min". The default is 50% and the range available is from 6% to 94%.
- Press **Min** and use  to set the minimum value of the measurement. Increasing the minimum value to the current "Mid" will automatically increase the "Mid" to keep it higher than the minimum value. The default is 10% and the range available is from 5% to 93%.

To Clear the Measurement

If you have currently enabled one or more items in the 24 measurement parameters, you can “Delete” or “Recover” the first five parameters or “Delete” or “Recover” all the measurement items enabled. Note that the first five parameters are determined according to the order in which you turned them on and they will not change as you delete one or more measurement items.

Press **Measure** → **Clear** → **Item n** to “Delete” or “Recover” the specified measurement item. When one measurement item is deleted or recovered, the measurement result at the bottom of the screen will move one-item left or right.

Press **Measure** → **Clear** → **All Items** to “Delete” or “Recover” all the measurement items enabled.

All Measurement

All measurement could measure all the time and voltage parameters (each measurement source has 20 items, measurements can be performed on CH1, CH2, CH3 and CH4 at the same time) of the current measurement source and display the results on the screen. Press **Measure** → **Measure All** to enable or disable the all measurement function. Press **All Measure Source** and use  to select the channel(s) to be measured (CH1-CH4).

- When all measurement is enabled, “One-key” measurement is also valid.
- “To Clear the Measurement” will not clear the results of all measurement.

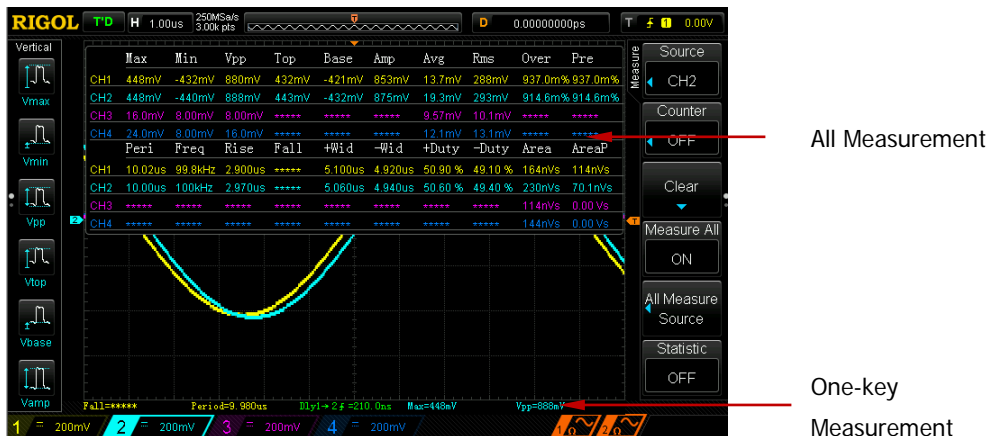

Statistic Function

Make statistic and display the current, average, minimum (or standard deviation) and maximum (or count) values of at most 5 measurement items that are turned on last. Press **Measure** → **Statistic** to turn the statistic function on or off. When the statistic function is enabled, press **Stat.Sel** to select “Extremum” or “Difference” measurement. When “Extremum” is selected, minimum and maximum values are displayed. When “Difference” is selected, standard deviation and count values are displayed.

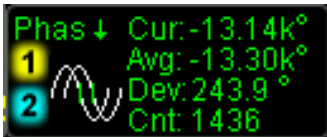

Extremum Measurement



Difference Measurement

Press **Measure** → **Reset Stat** to clear the history data and make statistic again.

Cursor Measurement

Cursors are the horizontal and vertical marks that can be used to measure the X axis values (usually Time) and Y axis values (usually Voltage) on a selected waveform. Please connect the signal to the oscilloscope and obtain stable display before using cursor measurement. All the "[Auto Measurement](#)" parameters can be measured through cursor measurement.

Press **Cursor** → **Mode** at the front panel and use  to select the desired cursor mode (the default is "OFF") and then press down the knob. The modes available are "Manual", "Track" and "Auto".

Manual Mode

In this mode, a pair of cursors will appear. You can adjust the cursors manually to measure the X (or Y), X increment (or Y increment) between cursors and the reciprocal of X increment on the waveform of the selected source (CH1, CH2 or MATH).

Press **Cursor** → **Mode** → “Manual” to turn the manual cursor function on and the measurement results will be displayed at the upper left corner of the screen in the following mode.

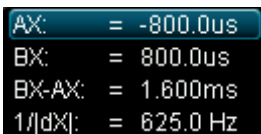

```

AX: = -800.0us
BX: = 800.0us
BX-AX: = 1.600ms
1/|dX|: = 625.0 Hz
  
```

- The X or Y value at cursor A (AX or AY): X value takes the trigger position as reference and Y value takes the channel GND as reference.
- The X or Y value at cursor B (BX or BY): X value takes the trigger position as reference and Y value takes the channel GND as reference.
- The horizontal or vertical difference between cursor A and B (BX-AX or BY-AY).
- The reciprocal of the horizontal difference between cursor A and B ($1/|dX|$).

If needed, please refer to the following steps to modify the parameters of manual cursor measurement.



1. Select Cursor Type

Press **Type** to select “X” or “Y”. The X cursors are a vertical dotted line (cursor A) and a vertical solid line (cursor B) and are usually used to measure time parameters. The voltage cursors are a horizontal dotted line (cursor A) and a horizontal solid line (cursor B) and are usually used to measure voltage parameters.

2. Select Measurement Source

Press **Source** to select the waveform of the analog channels (CH1-CH4) or math operation results (MATH) for measurement.

3. Adjust the Cursor Position (note that you can also press continuously to switch the current cursor)

- Adjust cursor A: press **CursorA** and use  to adjust the position of cursor A. During the adjustment, the measurement result will change accordingly. The adjustable range is limited within the screen.
- Adjust cursor B: press **CursorB** and use  to adjust the position of cursor B. During the adjustment, the measurement result will change accordingly. The adjustable range is limited within the screen.
- Adjust cursor A and B at the same time: press **CursorAB** and use  to adjust the position of cursor A and B at the same time. During the adjustment, the measurement results will change accordingly. The adjustable range is limited within the screen.

4. Select X (Y) Axis Unit

Press **Units** to set the horizontal unit and the vertical unit of the cursor measurement.

Press **Hori.Unit** to select "s", "Hz", "Degree" or "Percent".

- s: when this unit is selected, in the measurement results, AX, BX and BX-AX are in "s" and $1/|dX|$ is in "Hz".
- Hz: when this unit is selected, in the measurement results, AX, BX and BX-AX are in "Hz" and $1/|dX|$ is in "s".
- Degree: when this unit is selected, in the measurement results, AX, BX and BX-AX are in "°". At this point, AX, BX and BX-AX will change to "0°", "360°" and "360°" respectively when you press **Set Range**, no matter where cursor A and B are currently located. At the same time, two cursor lines (unmovable) appear on the screen as the reference positions.
- Percent: when this unit is selected, in the measurement results, AX, BX and BX-AX are in "%". At this point, AX, BX and BX-AX will change to "0%", "100%" and "100%" respectively when you press **Set Range**, no matter where cursor A and B are currently located. At the same time, two cursor lines (unmovable) appear on the screen as the reference positions.

Press **Vert.Unit** to select "Source" or "Percent".

- Source: when this unit is selected, in the measurement results, the units of AY, BY and BY-AY will be automatically set to the unit of the current source.
- Percent: when this unit is selected, in the measurement results, AY, BY and



BY-AY are in “%”. At this point, AY, BY and BY-AY will change to “0%”, “100%” and “100%” when you press **Set Range**, no matter where cursor A and B are currently located. At the same time, two cursor lines (unmovable) appear on the screen as the reference positions.

5. Measurement Example

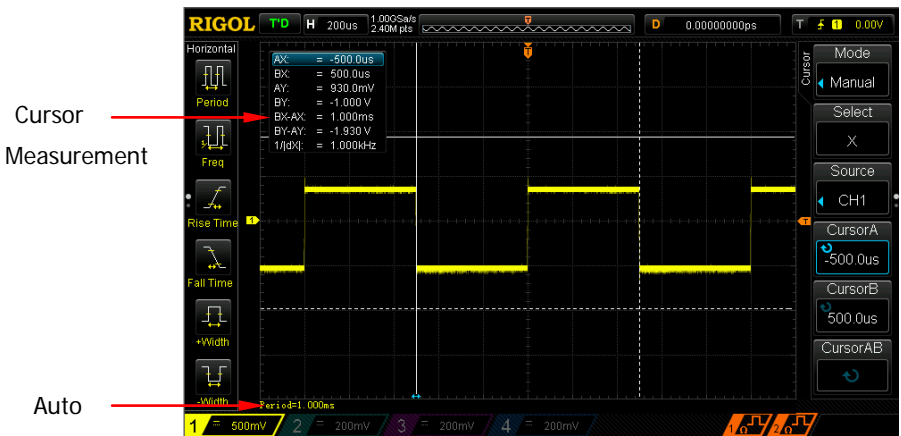
Use manual cursor measurement to measure the period (BX-AX) of a square waveform and the result is 1 ms equaling the result from auto measurement.



Track Mode

In this mode, one or two pairs of cursors will appear. You can adjust the two pairs of cursors (cursor A and cursor B) to measure the X and Y values on two different sources respectively. The points being measured on cursor A and B are marked by  and  respectively. When the cursors are moved horizontally, the marks will position on the waveform automatically. When the waveform is expanded or compressed horizontally, the marks will track the points being marked at the last adjustment of the cursors.

Press **Cursor** → **Mode** → “Track” to turn on the cursor track function and the measurement results will be displayed at the upper left corner of the screen in the following mode.

AX:	=	-4.000us
BX:	=	4.000us
AY:	=	-800.0mV
BY:	=	220.0mV
BX-AX:	=	8.000us
BY-AY:	=	1.020 V
1/ dX :	=	125.0kHz



- The X value at cursor A (AX): take the trigger position as reference and “s” or “Hz” (when measuring FFT waveform) as its unit.
- The Y value at cursor A (AY): take the channel GND as reference and use the same unit as the current source.
- The X value at cursor B (BX): take the trigger position as reference and “s” or “Hz” (when measuring FFT waveform) as its unit.
- The Y value at cursor B (BY): take the channel GND as reference and use the same unit as the current source.
- The horizontal difference between cursor A and B (BX-AX).
- The vertical difference between cursor A and B (BY-AY).
- The reciprocal of the horizontal difference between cursor A and B (1/|dX|).

If needed, please refer to the following steps to modify manual cursor track measurement parameters.

1. Select Measurement Source

Press **Cursor A** to select the waveform of analog channels (CH1-CH4) or math operation results (MATH) as the measurement source of cursor A (only channels enabled are available). You can also select "None", namely do not use cursor A. Press **Cursor B** to select the waveform of analog channels (CH1-CH4) or math operation results (MATH) as the measurement source of cursor B (only channels enabled are available). You can also select "None", namely do not use cursor B.

2. Adjust Cursor Position (note that you can also press continuously to switch the current cursor)

- Adjust cursor A: press **CursorA** and use  to adjust the position of cursor A. During the adjustment, the measurement result will change accordingly. The adjustable range is limited within the screen.
- Adjust cursor B: press **CursorB** and use  to adjust the position of cursor B. During the adjustment, the measurement result will change accordingly. The adjustable range is limited within the screen.
- Adjust cursor A and B at the same time: press **CursorAB** and use  to adjust the position of cursor A and B at the same time. During the adjustment, the measurement results will change accordingly. The adjustable range is limited within the screen.

Note: the vertical cursor will track the marked point (namely jumps up and down with the transient change of the waveform). Thus, the Y value might change even though you do not adjust the cursor.

Auto Mode

In this mode, one or more cursors will appear. You can use auto cursor measurement to measure any of the 24 waveform parameters. Before using this mode, you need to at least enable one auto measurement parameter and the number of cursors will change with the measurement parameter enabled.

Press **Cursor** → **Mode** → “Auto” and the number of cursors displayed on the screen is determined by the measurement parameter enabled (different measurement parameter needs different number of cursors). Note that no cursor will be displayed if no auto cursor measurement parameter is enabled or the measurement source has no input. When the waveform is expanded or compressed horizontally, the cursor will move accordingly.

If multiple measurement parameters are turned on later, you can use **Auto Item** to switch among at most five measurement parameters that are turned on last.

The following figure shows the auto measurement of the rise time of sinusoidal signal.

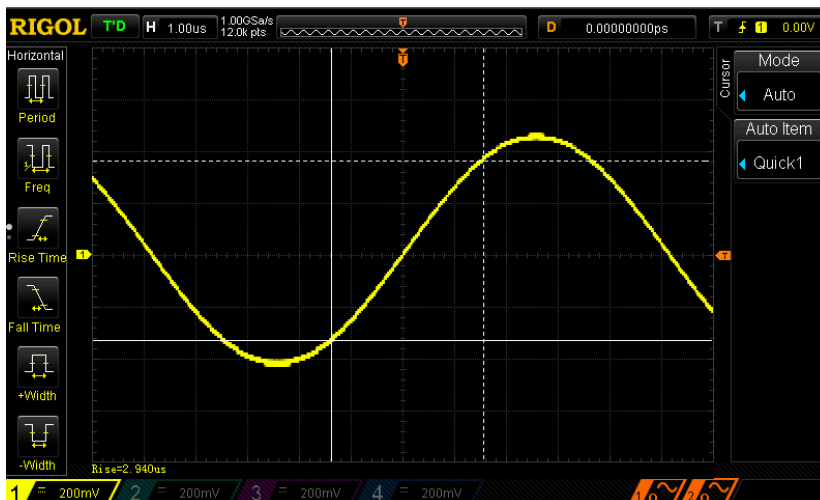

Chapter 7 Protocol Decoding

Protocol analysis can be used by users to discover errors, debug hardware and accelerate development easily, so as to guarantee quick and high-quality accomplishment of projects. Protocol decoding is the basis of protocol analysis. Only protocol analyses with correct protocol decoding are acceptable and only correct protocol decoding can provide more error information. DS1000Z provides two buses to make common protocol decoding (including Parallel (standard), RS232 (option), I2C (option) and SPI (option)) of the analog channels (CH1-CH4). As the decoding functions and setting methods of the two buses are the same, this chapter only takes Decode1 for illustration.

To get the decoding option information, please refer to "[Appendix A: Accessories and Options](#)".

When you have ordered the decoding option, please refer to "[Option Management](#)" to activate corresponding option.

The contents of this chapter:

- [Parallel Decoding](#)
- [RS232 Decoding \(Option\)](#)
- [I2C Decoding \(Option\)](#)
- [SPI Decoding \(Option\)](#)

Parallel Decoding

Parallel bus consists of clock line and data line. As shown in the figure below, CLK is the clock line, while Bit0 and Bit1 are the 0 bit and 1st bit on the data line respectively.

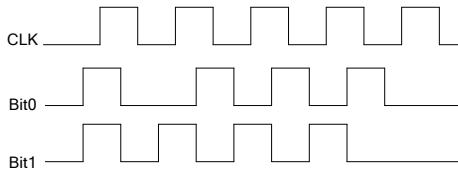



The oscilloscope will sample the channel data on the rising edge, falling edge or the rising&falling edges of the clock and judge each data point (logic "1" or logic "0") according to the preset threshold level.

Press **MATH** → **Decode1** → **Decoder** to select "Parallel" and open the parallel decoding function menu.

1. Press **Decode** to turn on or off the decoding function.

2. Clock Line Setting (CLK)

Press **CLK** to select any channel (CH1-CH4) as the clock channel. If "OFF" is selected, no clock channel is set.

Press **Edge** to set the oscilloscope to sample the channel data on the rising edge () , falling edge () or rising&falling edges (). If no clock channel is selected, the instrument will sample when the channel data jumps in the decoding.

3. Data Line Setting

- **Set the bus bits**

Press **Width** to set the data width of the parallel bus namely the number of bits per frame. The default is 1 and the maximum is 16 bits (Bit0, Bit1...Bit15).

- **Specify data channel for each bit.**

First, press **Bit X** to select the bit that needs to specify channel. The default

is 0 and the range available is always 1 smaller than the bus bits. For example, when the bus bits is 16, the range available is 0, 1...15.

Next, press **CH** to specify a channel source for the bit currently selected in **Bit X**.

4. Analog Channel Threshold Setting

To judge logic "1" and logic "0" of the buses, you need to set a threshold for each analog channel (CH1-CH4). When the signal amplitude is greater than the preset value, it is considered as "1"; otherwise "0".

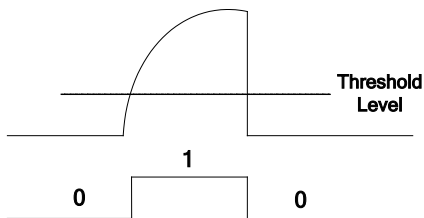

Press **MATH** → **Decode Options** → **Auto Thre.** to turn the auto threshold on or off.

When the auto threshold is turned on, the instrument will calculate the center point according to the current waveform trace automatically as the threshold of each channel before decoding.

When the auto threshold is turned off, you can press **Thre.Set** to turn the auto setting menu. Press **CH1**, **CH2**, **CH3**, **CH4** and use **↺** to set the threshold of each channel. Press **50%** to set the current threshold to 50% of the current waveform trace.

5. Display-related Setting

- Press **Format** to set the display format of the bus to Hex, Decimal, Binary, ASCII or LINE. Note that LINE format is displayed the actual value of the bus in a binary number form, and the order is consistent with the bus transmission sequence. This format is only valid for the serial bus, because the serial bus has the difference of bit sequence of LSB and MSB; if bit sequence of the bus is selected MSB, the LINE format is the same to the binary format.

- Press **Pos** and use  to adjust the vertical display position of the bus.

6. Decoding Configuration

Press **Decoding1 Configure** to turn the decoding configuration submenu on.

- Press **Label** to turn the label display function on or off. When it is turned on, the bus label will be displayed at the upper left of the bus (when the bus display is turned on).
- Press **Line** to turn the bus display function on or off. When it is turned on, the bus display will be displayed on the screen (when the bus display is turned on), and you can use **Pos** to adjust the vertical display position of the bus.
- Press **Format** to turn the format display function on or off. When it is turned on, the current format display of the bus will be displayed on the right of the label display (when the bus display is turned on), and you can use **format** to set the display format of the bus.
- Press **Width** to turn the width display function on or off. When it is turned on, the current bus width will be displayed on the right of the format display (when the bus display is turned on), and you can use **Width** softkey to set the bus width.
- Press **DataSrc** to select "Trace" or "Memory" as the data source.
- Press **Range** to select "Full" or "User". When "Full" is selected, the instrument will determine the decoding range according to the current selection of the current **data source**; when "User" is selected, press **Start** to set the start point of the decoding and the range available is from 0 to "end point - 1", and press **End** to set the end point of the decoding and the range available is from "start point +1" to 1199.

RS232 Decoding (Option)

RS232 serial bus consists of the transmitting data line (TX) and the receiving data line (RX).

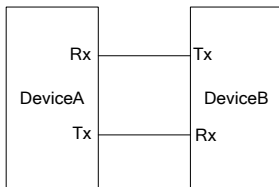

The industry standard of RS232 uses "Negative Logic", namely high level is logic "0" and low level is logic "1".

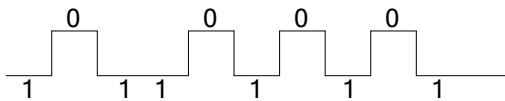

By default, RS232 uses LSB (Least Significant Bit) transmission sequence, namely the lowest bit of the data is transmitted first. While for MSB (Most Significant Bit), the highest bit of the data is transmitted first.

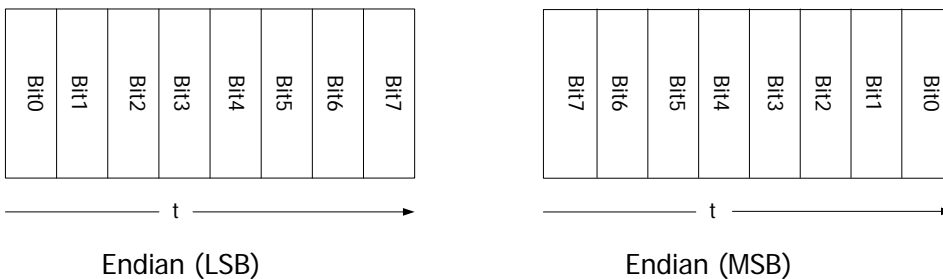

In RS232, baud rate is used to represent the transmitting rate (namely bits per second) of the data. The commonly used baud rates include 2400 bps, 4800 bps, 9600 bps, 19200 bps, 38400 bps, 57600 bps and 115200 bps.

In RS232, you need to set the start bit, data bits, check bit (optional) and stop bit of each frame of data.

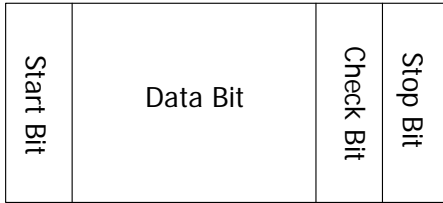

Start Bit: represent when the data starts outputting. Setting the **Polarity** is equivalent to specifying the "Start Bit".

Data Bits: represent the number of data bits actually contained in each frame of data.

Check Bit: used to check the correctness of the data transmission.

- **Odd Checkout:** the number of "1" in the data bit and check bit is an odd. For example, when 0x55 (01010101) is sent, a 1 needs to be filled in the check bit to make the number of 1 be an odd.
- **Even Checkout:** the number of "1" in the data bit and check bit is an even. For example, when 0x55 (01010101) is sent, a 0 should be filled in the check bit.
- **None:** there would not be check bit during the transmission.



Press **MATH** → **Decode1** → **Decoder** to select "RS232" and open the RS232 decoding function menu.

1. Press **Decode** to turn on or off the decoding function.

2. TX and RX Channel Setting

Press **TX** to select any channel (CH1-CH4) as the transmitting channel and when "OFF" is selected, no transmitting channel is set. Use the same method the set the **RX** channel.

3. Polarity Setting

Press **Polarity** to select " or " and the default is normal. The oscilloscope will select the rising or falling edge as the start position during decoding.

4. Baud Rate Setting

Press **Baud** use  to select the desired baud rate and you also can press **Preset** to select 2400, 4800, 9600, 57600, 115200, 230400, 460800, 921600 and 1000000 and the default is 9600, the unit is bps.

5. Endian Setting

Press **Endian** to select “LSB” or “MSB” and the default is “LSB”.

6. Data Packet Setting

As mentioned before, in RS232, you need to set the start bit, data bits, check bit (optional) and stop bit of each frame of data. “Start Bit” is specified by the “Polarity Setting”. The setting methods of other parameters are as follows.

- Press **Data** to set the data width of each frame. It can be set to 5, 6, 7, 8 or 9 and the default is 8.
- Press **Stop** to set the stop bit after each frame of data. It can be set to 1 bit, 1.5 bits or 2 bits.
- Press **Parity** to set the even-odd check mode of the data transmission. It can be set to None, Odd or Even.

7. Analog Channel Threshold Setting

To judge logic “1” and logic “0” of the buses, you need to set a threshold for each analog channel (CH1-CH4). When the signal amplitude is greater than the preset value, it is considered as “1”; otherwise “0”.

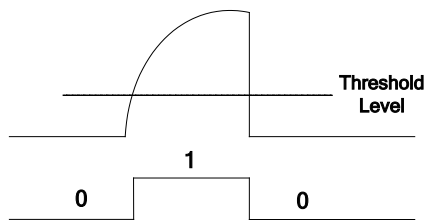

Press **MATH** → **Decode Options** → **Auto Thre.** to turn the auto threshold on or off.

When the auto threshold is turned on, the instrument will calculate the center point according to the current waveform trace automatically as the threshold of each channel before decoding.

When the auto threshold is turned off, you can press **Thre.Set** to turn the auto setting menu. Press **CH1**, **CH2**, **CH3**, **CH4** and use ↺ to set the threshold of each channel. Press **50%** to set the current threshold to 50% of the current waveform trace.

8. Display-related Setting

- Press **Format** to set the display format of the bus to Hex, Decimal, Binary, ASCII or LINE. Note that LINE format is displayed the actual value of the bus in a binary number form, and the order is consistent with the bus transmission sequence. This format is only valid for the serial bus, because the serial bus has the difference of bit sequence of LSB and MSB; if bit sequence of the bus is selected MSB, the LINE format is the same to the binary format.
- Press **Pos** and use  to adjust the vertical display position of the bus.

9. Decoding Configuration

Press **Decoding1 Configure** to turn the decoding configuration submenu on.

- Press **Label** to turn the label display function on or off. When it is turned on, the bus label will be displayed at the upper left of the bus (when the bus display is turned on).
- Press **Line** to turn the bus display function on or off. When it is turned on, the bus display will be displayed on the screen, and you can use **Pos** to adjust the vertical display position of the bus.
- Press **Format** to turn the format display function on or off. When it is turned on, the current format display of the bus will be displayed on the right of the label display (when the bus display is turned on), and you can use **Format** to set the display format of the bus.
- Press **Endian** to turn the endian display function on or off. When it is turned on, the current endian display will be displayed on the right of the format display (when the bus display is turned on), and you can use **Endian** to set the bus endian.
- Press **Width** to turn the width display function on or off. When it is turned on, the data width of each frame will be displayed on the right of the endian display (when the bus display is turned on), and you can use **Data** softkey to set the data width of each frame.
- Press **DataSrc** to select "Trace" or "Memory" as the data source.
- Press Range to select "Full" or "User". When "Full" is selected, the instrument will determine the decoding range according to the current selection of the current **data source**; when "User" is selected, press **Start** to set the start point of the decoding and the range available is from 0 to "end point - 1", and press **End** to set the end point of the decoding and the range available is from "start point + 1" to 1199.

10. The Error Expression during Decoding

End Frame Error:

Errors generated when the end frame condition is not met. When the stop bit is set to 1, "?" error mark will be displayed if the stop bit is less than 1.

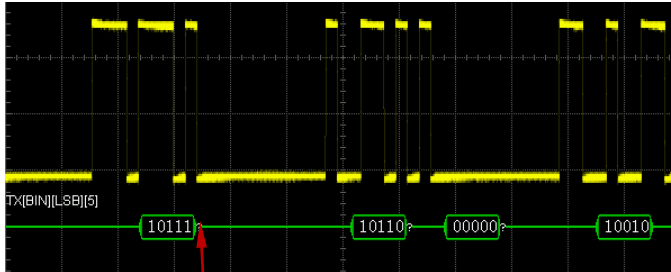

The stop bit is less than 1

Check Error:

When check bit error is detected during the decoding, "?" error mark will be displayed. For example, when the transmitting terminal is set to none check and the decoder is set to odd check, the following check error occurs.

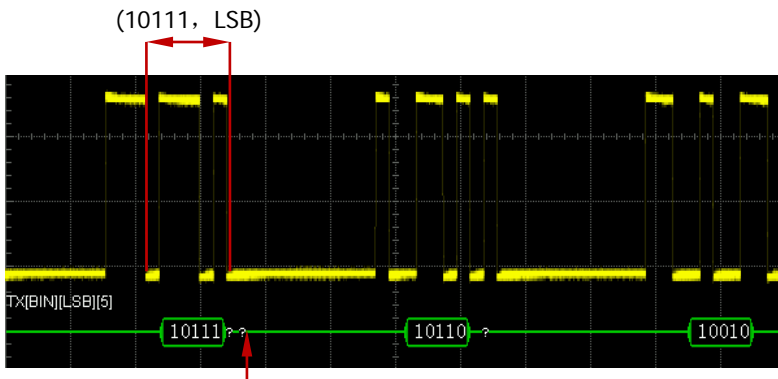

The check bit detected is 0

Wherein, there are odd number (1) of 1 in the 5-bit data 10111 and the check bit should be 1; but the check bit detected on the TX is 0, thus check error occurs.

Note that two error marks will be displayed when end frame error and check error are detected at the same time.

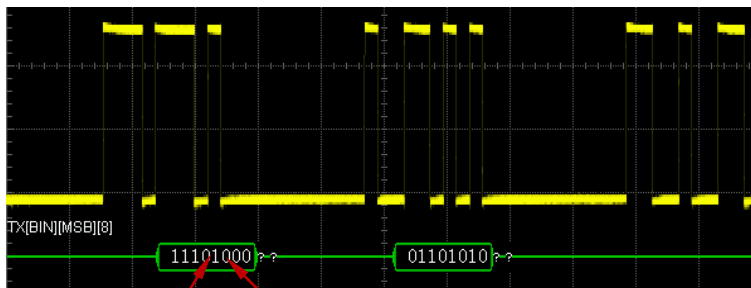

End frame error Check frame error

I2C Decoding (Option)

I2C serial bus consists of the clock line (SCLK) and the data line (SDA).

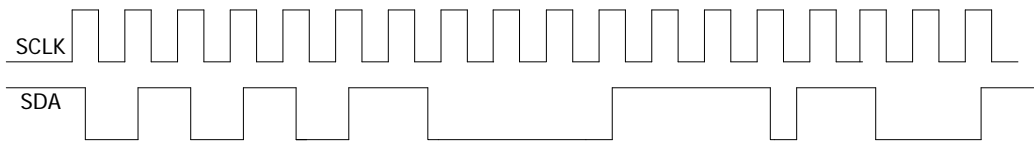
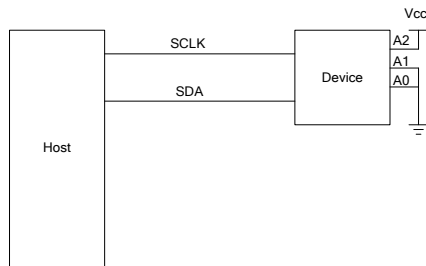

SCLK: sample the SDA on the clock rising edge or falling edge.

SDA: denote the data channel.

Press **MATH** → **Decode1** → **Decoder** to select "I2C" and open the I2C decoding function menu.

1. Press **Decode** to turn on or off the decoding function.
2. **SCLK Setting**
Press **CLK** to select any channel (CH1-CH4) as the clock channel.
3. **SDA Setting**
Press **SDA** to select any channel (CH1-CH4) as the data channel.

Note that press **Exchange** to change the source of clock between the clock source and data source.

4. Analog Channel Threshold Setting

To judge logic "1" and logic "0" of the buses, you need to set a threshold for each analog channel (CH1-CH4). When the signal amplitude is greater than the preset value, it is considered as "1"; otherwise "0".

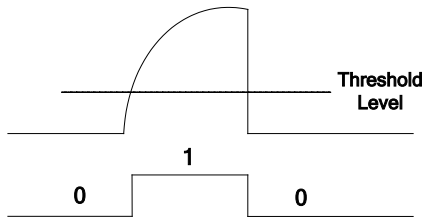

Press **MATH** → **Decode Options** → **Auto Thre.** to turn the auto threshold on or off.

When the auto threshold is turned on, the instrument will calculate the center point according to the current waveform trace automatically as the threshold of each channel before decoding.

When the auto threshold is turned off, you can press **Thre.Set** to turn the auto setting menu. Press **CH1**, **CH2**, **CH3**, **CH4** and use **↺** to set the threshold of each channel. Press **50%** to set the current threshold to 50% of the current waveform trace.

5. Display-related Setting

- Press **Format** to set the display format of the bus to Hex, Decimal, Binary, ASCII or LINE. Note that LINE format is displayed the actual value of the bus in a binary number form, and the order is consistent with the bus transmission sequence. This format is only valid for the serial bus, because the serial bus has the difference of bit sequence of LSB and MSB; if bit sequence of the bus is selected MSB, the LINE format is the same to the binary format.
- Press **Pos** and use **↺** to adjust the vertical display position of the bus.

6. Decoding Configuration

Press **Decoding1 Configure** to turn the decoding configuration submenu on.

- Press **Label** to turn the label display function on or off. When it is turned on, the bus label will be displayed at the upper left of the bus (when the bus

display is turned on).

- Press **Line** to turn the bus display function on or off. When it is turned on, the bus display will be displayed on the screen, and you can use **Pos** to adjust the vertical display position of the bus.
- Press **Format** to turn the format display function on or off. When it is turned on, the current format display of the bus will be displayed on the right of the label display (when the bus display is turned on), and you can use **Format** to set the display format of the bus.
- Press **Endian** to turn the endian display function on or off. When it is turned on, the current endian display will be displayed on the right of the format display (when the bus display is turned on), and the default is MSB.
- Press **Width** to turn the width display function on or off. When it is turned on, the data width of each frame will be displayed on the right of the endian display (when the bus display is turned on), and the default is 8.
- Press **DataSrc** to select "Trace" or "Memory" as the data source.
- Press **Range** to select "Full" or "User". When "Full" is selected, the instrument will determine the decoding range according to the current selection of the current **data source**; when "User" is selected, press **Start** to set the start point of the decoding and the range available is from 0 to "end point - 1", and press **End** to set the end point of the decoding and the range available is from "start point + 1" to 1199.

7. Address Information during Decoding

In I2C bus, the front part of each frame of data contains the address information and blue patches are used to represent address ID. In the ID, "Write" is used to represent writing address and "Read" is used to represent reading address.

Press **ADDR** to select "Normal" or "R/W". when "R/W" is selected, "R/W" bit will be as a part of the address value in the **Address**.



8. Error Information during Decoding

When the ACK (ACKnowledge Character) is not met, "?" error marks as shown in the figure below will be displayed.

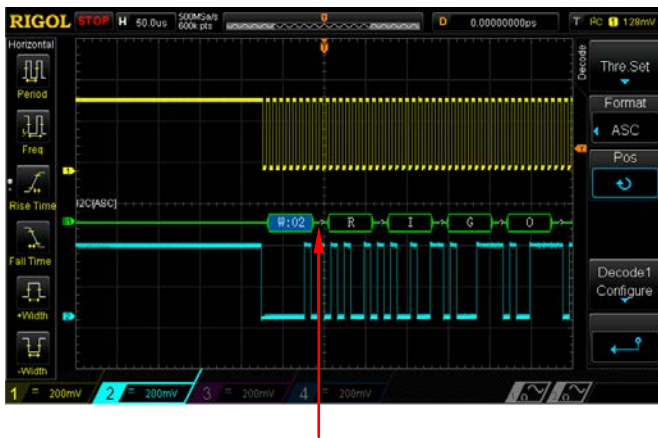

ACK=1

SPI Decoding (Option)

SPI serial bus consists of clock line (SCLK) and data line (SDA).

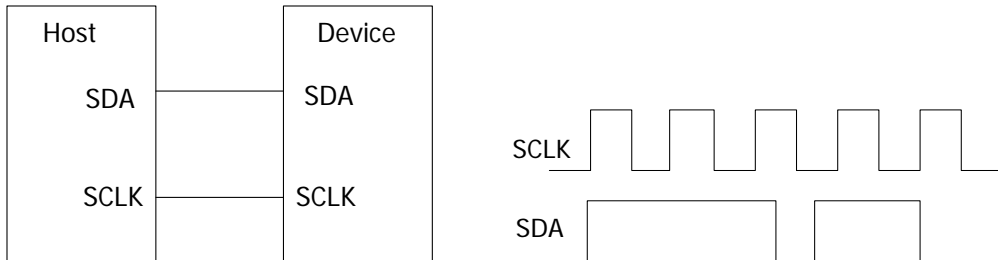

SCLK: sample the SDA on the clock rising edge or falling edge.

SDA: denote the data channel.

Press **MATH** → **Decode1** → **Decoder** to select "RS232" and open the RS232 decoding function menu.

1. Press **Decode** to turn on or off the decoding function.

2. Decoding Mode Setting

Press Mode to set the decoding mode of SPI, you can selected "CS" or "Timeout".

CS: when CS selection is valid, the SPI bus samples the data at the jumping point of CLK. After selecting this mode, press CS to select any channel (CH1-CH4) as the CS channel. If "OFF" is selected, no CS channel is set.

Timeout: when this trigger condition is selected, press **Timeout** to set the minimum time that the clock (SCL) signal must be idle before the oscilloscope will search for the data (SDA) on which to decode. The range is from 100 ns to 1 s.

3. CLK Setting

Press **CLK** to select any channel (CH1-CH4) as the clock channel.

4. MISO Setting

Press **MISO** to select any channel (CH1-CH4) as the MISO data channel. When "OFF" is selected, this data line is not set.

5. MOSI Setting

Press **MOSI** to select any channel (CH1-CH4) as the MOSI data

6. Edge Setting

Press **Edge** to sample the MISO and MOSI at the rising edge or falling edge of CLK.

7. Polarity setting

Press **Polarity** to set the polarity of the SDA data line to **11** (the high level is 1) or **1** (the low level is 1).

8. Width Setting

Press **Width** to set the bit width of each frame. The range available is from 8 to 32.

9. Endian Setting

Press **Endian** to select "LSB" or "MSB" and the default is "MSB".

10. Display-related Setting

- Press **Format** to set the display format of the bus to Hex, Decimal, Binary, ASCII or LINE. Note that LINE format is displayed the actual value of the bus in a binary number form, and the order is consistent with the bus transmission sequence. This format is only valid for the serial bus, because the serial bus has the difference of bit sequence of LSB and MSB; if bit sequence of the bus is selected MSB, the LINE format is the same to the binary format.
- Press **Pos** and use  to adjust the vertical display position of the bus.

11. Decoding Configuration

Press **Decoding1 Configure** to turn the decoding configuration submenu on.

- Press **Label** to turn the label display function on or off. When it is turned on, the bus label will be displayed at the upper left of the bus (when the bus display is turned on).

- Press **Line** to turn the bus display function on or off. When it is turned on, the bus display will be displayed on the screen, and you can use **Pos** to adjust the vertical display position of the bus.
- Press **Format** to turn the format display function on or off. When it is turned on, the current format display of the bus will be displayed on the right of the label display (when the bus display is turned on), and you can use **Format** to set the display format of the bus.
- Press **Endian** to turn the endian display function on or off. When it is turned on, the current endian display will be displayed on the right of the format display (when the bus display is turned on), and you can use **Endian** to set the bus endian.
- Press **Width** to turn the width display function on or off. When it is turned on, the data width of each frame will be displayed on the right of the endian display (when the bus display is turned on), and you can use **Width** to set the data width of each frame.
- Press **DataSrc** to select "Trace" or "Memory" as the data source.
- Press **Range** to select "Full" or "User". When "Full" is selected, the instrument will determine the decoding range according to the current selection of the current **data source**; when "User" is selected, press **Start** to set the start point of the decoding and the range available is from 0 to "end point - 1", and press **End** to set the end point of the decoding and the range available is from "start point + 1" to 1199.

Chapter 8 Reference Waveform



In actual testing process, the waveform being tested can be compared with the reference waveform to judge the causes of failures.

The contents of this chapter:

- [To Enable REF Function](#)
- [To Select REF Source](#)
- [To Adjust REF Waveform Display](#)
- [To Save to Internal Memory](#)
- [To Set the Color](#)
- [To reset the REF waveform](#)
- [To Export to Internal or External Memory](#)
- [To Import from Internal or External Memory](#)

To Enable REF Function

Press **REF** in the vertical control area (VERTICAL) at the front panel to enable the REF function. Note that when the time base is in XY mode, REF function can not be enabled.

DS1000Z provides 10 reference waveform channels. Press **Channel** and use  to set the desired reference channel to on or off and a channel icon (for example, ) of the channel enabled will be display at the left side of the screen grid.

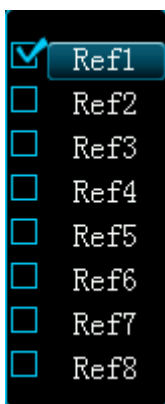



When the REF function is enabled, you can select different color for each reference waveform, set the source of each reference channel, adjust the vertical scale and position of the reference waveform and save the reference waveform to internal or external memory as well as recall it when needed. For details, please refer to the introductions below.

To Select REF Source

Press **Current** and use  to select any of the reference channels (Ref1 to Ref10) enabled and then press **Source** to specify a reference source (CH1-CH4 or MATH) for this channel.

To Adjust REF Waveform Display

To adjust the reference waveform specified in **Current**:



Press **REF** to enable the REF function. Then, press **Offset** and use  to adjust the vertical position of the reference waveform and press **Scale** and use  to adjust the vertical scale of the reference waveform.

To Save to Internal Memory

Press **Save** to save the waveform (screen region) in the specified source to internal memory as reference waveform and display it on the screen. Note that this operation only saves the reference waveform in the volatile memory and the waveform will be cleared at power-off.

To Set the Color

DS1000Z series oscilloscope provides five colors (gray, green, light blue, magenta and orange) to mark the reference waveforms of different channels in order to distinguish them.

Press **Current** and use  to select any of the reference channels (Ref1-Ref10) enabled. Then, press **Color** to specify a different color for the reference waveform of that channel. The corresponding icon at the left of the channel currently selected will be filled with the specified color, for example, .

To reset the REF waveform

Press **Reset** and the reference waveform returns to the position where the source channel waveform is located when the **Save** operation was executed.

To Export to Internal or External Memory

Users can also save the reference waveform to the internal Flash memory or external USB storage device. The file format of the reference waveform is "*.ref". At most 10 reference files (LocalREF0.ref to LocalREF9.ref) can be saved inside the instrument.

Press **Export** to enter the file store interface. Please refer to the relative descriptions in "[13 Store and Recall](#)" to save the reference waveform to internal or external memory.

To Import from Internal or External Memory

Users can also import the reference waveform stored in the internal Flash memory or external USB storage device to the internal memory.

Press **Import** to enter the file recall interface. Please refer to the relative descriptions in "[13 Store and Recall](#)" to import the reference waveform to the internal memory of the instrument.

Chapter 9 Pass/Fail Test

Monitor the change of the signal by judging whether the input signal is within the mask created. The test results can be displayed on the screen as well as be declared through the system sound or the pulse signal output from the **[Trigger Out]** connector at the rear panel.

The contents of this chapter:

- [To Enable Pass/Fail Test](#)
- [To Select Source](#)
- [Mask Range](#)
- [Test and Output](#)
- [To Save the Test Mask](#)
- [To Load the Test Mask](#)

To Enable Pass/Fail Test

Press **Utility** → **Pass/Fail** → **Enable** to select "ON". Note that when the time base is in XY mode, the Pass/Fail test function can not be enabled.

To start testing, press **Enable** and select "ON". Then, press **Operate** to select "▶" to start testing and select "■" to stop testing.

You can select the signal source, set the test mask range, create mask as well as save and load the test mask. For details, please refer to the following introductions.

To Select Source

Press **Source** to select the channel (CH1-CH4) to be tested and only channels enabled can be selected. During the test, the oscilloscope will judge whether each frame of waveform in the source complies with the current test mask and those waveforms pass through the mask area (blue area) is considered as failed.

Mask Range

Users can define their desired test masks. The test mask is "Screen" by default.

Press **Range** to enter the mask range setting menu. Press **X Mask** and **Y Mask**, rotate  and the mask lines appear on the screen as shown in the figure below. Press **Create Mask** to apply the mask currently created. The horizontal and vertical adjustment ranges are 0.02 div to 4.0 div and 0.04 div to 5.12 div respectively.

Test and Output

Before the test, you can use the following method to set the output mode of the test results.

Press **Stat.Disp** to select "ON" or "OFF". When "ON" is selected, the test results will be displayed at the upper right corner of the screen.

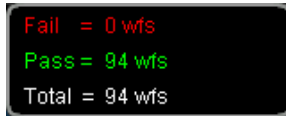

Press Stat.Disp to clear the current statistic and restatistic the test result.

Press **Stop On Fail** to select "ON" or "OFF".

- ON: when failed waveforms are detected, the oscilloscope will stop the test and enter the "STOP" state. At this point, the results of the test remain the same on the screen (if display is turned on) and only one pulse is output from the **[Trigger Out]** connector (if enabled) at the rear panel.
- OFF: the oscilloscope will continue with the test even though failed waveforms are detected. The test results on the screen will update continuously and a pulse will be output from the **[Trigger Out]** connector at the rear panel each time a failed waveform is detected.

Press **Output** to select "🔊" or "🔇".

- 🔊: failed waveforms are detected, there are display and output but the beeper does not sound.
- 🔇: failed waveforms are detected, there are display and output and the beeper sounds (not related to the on/off state of the sound).

Press **AuxOutput** to quickly turn "ON" or "OFF" the output of test results from the **[Trigger Out]** connector at the rear panel. You can also press **Utility** → **AuxOutput** and select "PassFail" to set this output.

To Save the Test Mask

Users can save the current test mask to the internal Flash memory or external USB storage device. The file format of the test mask file is "*.pf". The internal memory can store at most 10 test mask files (LocalPF.pf).

Press **Save** to enter the file store interface. Please refer to the relative descriptions in "[13 Store and Recall](#)" to save the test mask file to the internal or external memory.

To Load the Test Mask

Users can also load the test mask files (*.pf) stored in the internal Flash memory or external USB storage device to the internal memory.

Press **Load** to enter the file recall interface. Please refer to the relative descriptions in "[13 Store and Recall](#)" to load the test masks to the internal memory of the instrument.

Chapter 10 Waveform Record

Waveform record can record the waveforms of the input channels (CH1-CH4). Waveform playback and analysis can provide better waveform analysis effect. (Note: the horizontal time base must be set to YT mode during waveform record.)

Press **Utility** → **Record** → **Record** to turn the waveform record on or off.

1. Waveform Record

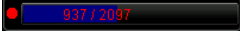
Press **Record** to start the waveform record, the current record information at the upper right corner (e.g. ) would change accordingly during the waveform record process and "●" will change into "■" automatically in the menu. At this point, press Record again to stop the waveform record. You can set the parameter of the waveform record according to the instruction of "[Playback Setting](#)" before waveform record.

2. Playback

Press **Play** to play the waveform recorded. For specified setting of playing, please refer to the instruction of "[Record Setting](#)".

3. Stop

You can press **Stop** to stop the playback during the waveform playback process.

4. Current Frame

Press Current and use  to set the current frame, the default is the maximum number of frames recorded. During the setting, the screen will display the corresponding waveform of the current frame synchronously, namely manual playback.

The contents of this chapter:

- [Playback Setting](#)
- [Record Setting](#)

Playback Setting

Waveform playback can play back the waveforms currently recorded. At this point, the information as shown in the figure below is displayed at the upper right corner of the screen; the data on the left indicates the specific frame currently displayed on the screen and during the playback, this value would change continuously. The data on the right indicates the maximum number of frames that can be recorded currently.



Please refer to the following descriptions to set the playback parameters.

1. Play Mode

Press **Mode** to set the playback mode to cycle or single.

- : cycle playback. Play from the start frame to the end frame and then repeat until you stop it manually.
- : single playback. Play from the start frame to the end frame and then stop.

2. Play Direction

Press **Dir** to set the playback direction to forward direction or inverse direction.

- : forward direction, Play from the start frame to the end frame.
- : inverse direction, play from end frame to start frame.

3. Interval

Press **Interval** and use to set the time interval of playback. The range available is from 100 ns to 10 s and the default is 100 ns.

4. Start Frame

Press **Start** and use to set the start frame of playback. The default is 1 and the maximum is the maximum number of frames recorded.

5. End Frame

Press **End** and use to set the end frame of the playback. The default is the total number of frames of the waveform recorded.

Tip

During waveform playback, **RUN/STOP** can be used to switch between playback and pause. Each time **SINGLE** is pressed, the **Current Frame** moves one frame forward.

Record Setting

You can press **Record Opt** to set the following parameters before waveform record.

1. Interval

Press **Interval** to set the time interval between frames in waveform recording and the range available is from 100 ns to 10 s.

2. Record Length



Press **Length** to set the number of frame currently recorded and the range available is from 1 to the maximum number of frames that can be recorded currently. Press **Set Max** to set the number of frame to the maximum number of frames that can be recorded.

3. Maximum Number of Frames

The menu shows the maximum number of frames that can be recorded currently.

As the capacity of the waveform memory is fixed, the more the number of points each frame of waveform has, the less the number of waveform frames can be recorded. Thus, the maximum end frame of waveform record is decided by the "Memory Depth" currently selected. Please refer to the instruction in "**Memory Depth**" to select the desired memory depth.

4. Beep

- : you can not hear the sound of the beeper when the waveform recording is over.
- : you can hear the sound of the beeper when the waveform recording is over.

Chapter 11 Display Control

You can set the type, persistence time and brightness of waveform display as well as the grid type, grid brightness of the screen display and the menu display time.

The contents of this chapter:

- [To Select the Display Type](#)
- [To Set the Persistence Time](#)
- [To Set the Waveform Intensity](#)
- [To Set the Screen Grid](#)
- [To Set the Grid Brightness](#)
- [To Set the Menu Display](#)

To Select the Display Type

Press **Display** → **Type** to set the waveform display mode to “Vectors” or “Dots”.

- Vectors: the sample points are connected by lines and displayed. Normally, this mode can provide the most vivid waveform to view the steep edge of the waveform (such as square waveform).
- Dots: display the sample points directly. You can directly view each sample point and use the cursor to measure the X and Y values of the sample point.

To Set the Persistence Time

Press **Display** → **Persis.Time** to set the persistence time of the oscilloscope to Min, specific values (100 ms, 200 ms, 500 ms, 1 s, 2 s, 5 s, 10 s and 20 s) or Infinite.

In the following part, a frequency sweep signal of the sine waveform is used to demonstrate the waveform effects in different persistence times.

1. Min

Enable to view waveform changing in high refresh rate.

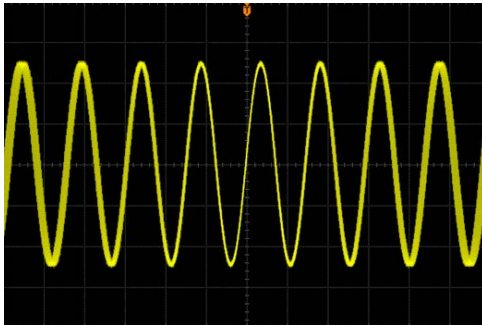

2. Specific Values

Enable to observe glitch that changes relatively slowly or glitch with low occurrence probability. The persistence time can be set to 50 ms, 100 ms, 200 ms, 500 ms, 1 s, 2 s, 5 s, 10 s or 20 s.

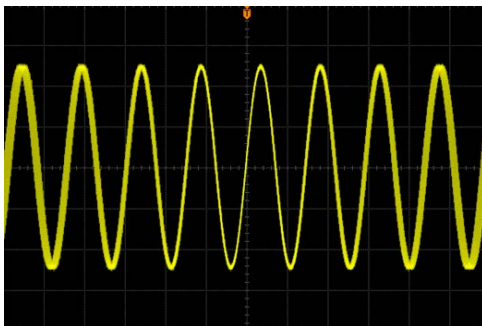

3. Infinite

In this mode, the oscilloscope displays the waveform newly acquired without clearing the waveforms acquired formerly. The waveforms acquired formerly will be displayed in relatively low-brightness color and the waveform newly acquired

will be displayed in normal brightness and color. Infinite persistence can be used to measure noise and jitter and to capture incidental events.





To Set the Waveform Intensity

Press **Display** → **WaveIntensity** or turn  when the menu is hidden to adjust the waveform brightness of the analog channel. The default is 50% and the range available is from 0% to 100%.

To Set the Screen Grid

Press **Display** → **Grid** to set the screen grid type.

- : turn the background grid and coordinate on.
- : turn the background grid off.
- : turn the background grid and coordinate off.

To Set the Grid Brightness

Press **Display** → **Brightness** to set the brightness of the screen grid. Turn  to adjust the grid brightness. The default is 50% and the range available is from 0% to 100%.

To Set the Menu Display

Press **Display** → **Menu Display** to set the menu display time. The menu will hold for a specified period of time after the last button-pressing action and then is hidden. The display time can be set to 1 s, 2 s, 5 s, 10 s, 20 s or Infinite (the menu will not be hidden).

Chapter 12 Signal Source

It is particularly suitable for the test application of excitation-response with the dual-channel, 25 MHz signal source built-in the oscilloscope and it is very convenient for the engineers who need both signal source and oscilloscope to combine the signal source with the oscilloscope. This chapter will introduce how to use the signal source built-in the oscilloscope. As the function and the setting method of the two channels of the signal are the same, this chapter only takes **source1 setting** for illustration.

Press **Source** menu key to enter the signal setting interface:

Press **Output** to turn the signal output on or off. After "ON" is selected, the instrument will output the signal currently set from the **[Source1]** connector at the rear panel.

Note: you also can turn on the signal output by the **Output** under the **Src1 Setup** submenu.

Press **Src1 Setup** to select the signal type currently output and set the relative parameters of the signal.

Press StatusDisp to view the current signal status of SOURCE1 and SOURCE2, for example, frequency, amplitude, offset, phase, modulation type and modulation frequency.

The contents of this chapter:

- [To Output Basic Waveform](#)
- [To Output Built-In Waveform](#)
- [To Output Arbitrary Waveform](#)

To Output Basic Waveform

To Output Sine Waveform

Press **Src1 Setup** to enter the waveform setting interface. Press **Wave** to select "Sine", at this point, you can set relative parameters of the sine signal.

1. Output

Press **Output** to turn the signal output on or off.

2. To set frequency

Press **Frequency** to set the frequency of the current signal and the range available is from 100 mHz to 25 MHz. Note that different waveform has different frequency, the frequency ranges of square and pulse are 100 mHz to 15 MHz; the frequency range of ramp is 100 mHz to 100 kHz.

Method one:

Rotate  directly to set the desired frequency value.

Method two:

Press  to input desired parameter values and adjust directly using the pop-up numeric keyboard.

3. To set amplitude

Press **Amplitude** to set the amplitude of the current signal and the range available is from 20 mVpp to 5 Vpp (if the impedance is "HighZ") or from 10 mVpp to 2.5 Vpp (if the impedance is "50 Ω").

Method one:

Rotate  directly to set the desired amplitude value.

Method two:

Press  to input desired parameter values and adjust directly using the pop-up numeric keyboard.

4. To set the DC offset voltage

Press **Offset** to set the DC offset of the current signal and the range available is from "-2.5 V + the amplitude value currently set/2" (if the impedance is "HighZ") to "2.5 V + the amplitude value currently set/2" (if the impedance is "50 Ω").

Rotate  directly to set the desired DC offset value.

Method two:

Press  to input desired parameter values and adjust directly using the pop-up numeric keyboard.

Note that the offset value is only remained three significant figures. For example, when the amplitude is set to 10 mV (the impedance is 50Ω), the offset range calculated is -1.245 V to 1.245 V, but the actual offset range is -1.24 V to 1.24 V.

5. To set the start phase

Press **Start** Phase to set the start phase of the current signal and the range available is from 0° to 360°.

Method one:

Rotate  directly to set the desired start phase.

Method two:

Press  to input desired parameter values and adjust directly using the pop-up numeric keyboard.

6. Align phase

Press **AlignPhase** to re-configuration the two channels and enable the signal source to output with specified frequency and phase. For two signals whose frequencies are the same or in multiple, this operation will align their phase. Use the oscilloscope to sample and display the waveforms of the two channels and you will see that the phase of the two waveforms shown on the oscilloscope changed. At this point, press **AlignPhase** and the waveforms on the oscilloscope will restore the current phase deviation of the two channels.

7. Modulation

Press **Modulation** to turn the modulation function on or off. For detailed information about modulation function, please refer to "[Modulation](#)".

8. To set impedance

Press **Impedance** to set the output impedance of the current signal, "HighZ" and "50Ω" can be selected.

To Output Square Waveform

Press **Src1 Setup** to enter the waveform setting interface. Press **Wave** to select "Square", at this point, you can set relative parameter of the sine signal. For the specified setting method, please refer to the instruction of "[To Output Sine Waveform](#)".

To Output Ramp Waveform

Press **Src1 Setup** to enter the waveform setting interface. Press **Wave** to select "Ramp", at this point, you can set relative parameter of the sine signal. For the specified setting method, please refer to the instruction of "[To Output Sine Waveform](#)". "symmetry" is introduced only in this chapter.

Symmetry

Symmetry is defined as the percentage that the rising period of ramp waveform takes up in the whole period.

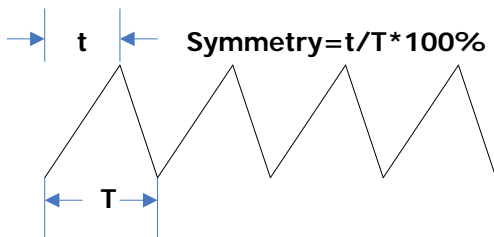

To set the symmetry

Press **Symmetry** and use  to set the symmetry of the current ramp and the range available is from 0% to 100%.

To Output Pulse Waveform

Press **Src1 Setup** to enter the waveform setting interface. Press **Wave** to select "Pulse", at this point, you can set relative parameter of the sine signal. For the specified setting method, please refer to the instruction of "[To Output Sine Waveform](#)". "Duty cycle" is introduced only in this chapter.

Duty cycle

Duty cycle is defined as the percentage that the high level takes up in the whole period of pulse.

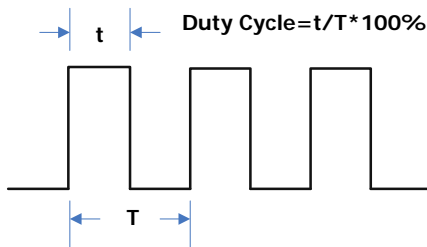

To set the duty cycle

Press **Duty Cycle** and use  to set the duty cycle of the current pulse signal and the range available is from 10% to 90%.

To Output DC Waveform

Press **Src1 Setup** to enter the waveform setting interface. Press **Wave** to select "DC", at this point, you can output DC signals with -2.5 V to +2.5 V offset.

1. Output

Press **Output** to turn the signal output on or off.

2. To set DC offset

Press **Offset** to set the offset value of the current DC signal and the range available is -2.5 V to +2.5 V. For the setting method, please refer to the instruction of "[To set the DC offset voltage](#)".

To Output Noise Waveform

Press **Src1 Setup** to enter the waveform setting interface. Press **Wave** to select "Noise", at this point, you can output noise signals with specified amplitude.

1. Output

Press **Output** to turn the signal output on or off.

2. To set amplitude

Press **Amplitude** to set the amplitude of the current signal and the range available is from 20 mVpp to 5Vpp (when the impedance is "HighZ") or from 10 mVpp to 2.5 Vpp (when the impedance is "50 Ω"). For setting method please refer to the instruction of "[To set amplitude](#)".

3. To set the DC offset voltage

Press **Offset** to set the DC offset of the current signal and the range available is from "-2.5 V + the amplitude value currently set/2" (when the impedance is "HighZ") to "2.5 V + the amplitude value currently set/2" (when the impedance is "50 Ω"). For setting method please refer to the instruction of "[To set the DC offset voltage](#)".

Note that the offset value is only remained three significant figures. For example, when the amplitude is set to 10 mV (the impedance is 50 Ω), the offset range calculated is -1.245 V to 1.245 V, but the actual offset range is -1.24 V to 1.24 V.

To Output Built-In Waveform

7 kinds of built-in waveforms are provided by signal source built-in in the DS2000A series oscilloscope, including Sinc, Exp.Rise, Exp.Fall, ECG, Gauss, Lorentz, Haversine.

Sinc

The figure below shows a Sinc waveform.

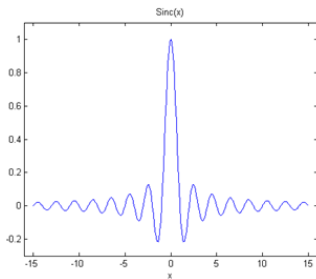

Exponential Rise

The figure below shows an Exponential Rise waveform.

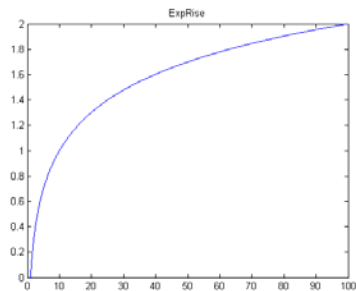

Exponential Rise

The figure below shows an Exponential Rise waveform.

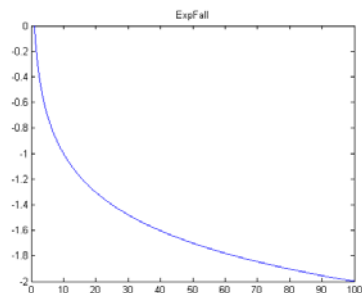

ECG

The figure below shows an ECG waveform.

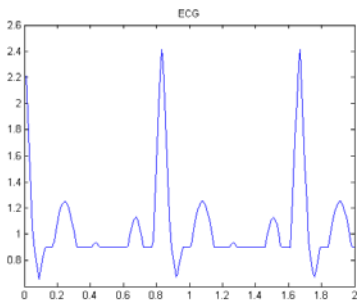

Guass

The figure below shows a Guass waveform.

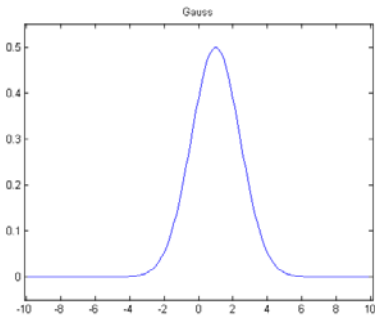

Lorentz

The figure below shows a Lorentz waveform.

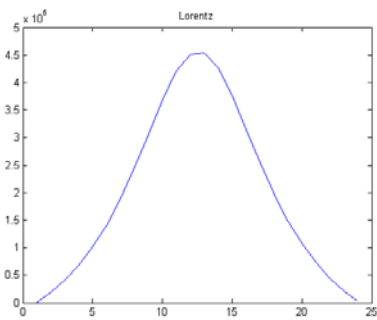

Haversine

The figure below shows a Haversine waveform.

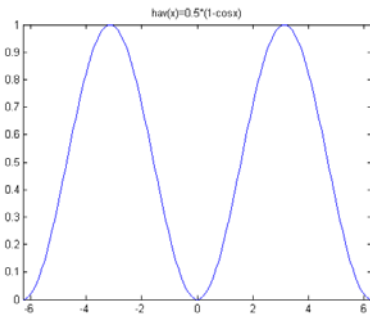

Press **Src1 Setup** to enter the waveform setting interface. Press **Wave** to select "Built-In", at this point, you can set relative parameter of the output signal according to the kinds of built-in waveform selected.

1. Output

Press **Output** to turn the signal output on or off.

2. To select built-in waveform

Press **Built-In** to select any one of the 7 kinds of built-in waveforms.

3. To set frequency

Press **Frequency** to set the frequency of the current signal and the range available is from 100 mHz to 1 MHz.

Method one:

Rotate  directly to set the desired frequency value.

Method two:

Press  to input desired parameter values and unist directly using the pop-up numeric keyboard.

4. To set amplitude

Press **Amplitude** to set the amplitude of the current signal and the range available is from 20 mVpp to 5Vpp (when the impedance is "HighZ") or from 10 mVpp to 2.5 Vpp (when the impedance is "50 Ω").

Method one:

Rotate  directly to set the desired implitude value.

Method two:

Press  to input desired parameter values and adjust directly using the pop-up numeric keyboard.

5. To set the DC offset voltage

Press **Offset** to set the DC offset of the current signal and the range available is from “-2.5 V + the amplitude value currently set/2” (when the impedance is “HighZ”) to “2.5 V + the amplitude value currently set/2” (when the impedance is “50 Ω”).

Rotate  directly to set the desired DC offset value.

Method two:

Press  to input desired parameter values and adjust directly using the pop-up numeric keyboard.

The offset value is only rounded to three significant figures. For example, when the amplitude is set to 10 mV (the impedance is 50 Ω), the offset range calculated is -1.245 V to 1.245 V, but the actual offset range is -1.24 V to 1.24 V.

6. To set the start phase

Press **Start Phase** to set the start phase of the current signal and the range available is from 0° to 360°.

Method one:

Rotate  directly to set the desired start phase.

Method two:

Press  to input desired parameter values and adjust directly using the pop-up numeric keyboard.

7. Align phase

Press **AlignPhase** to re-configure the two channels and enable the signal source to output with specified frequency and phase. For two signals whose frequencies are the same or in multiple, this operation will align their phase. Use the oscilloscope to sample and display the waveforms of the two channels and you will see that the phase of the two waveforms shown on the oscilloscope changed. At this point, press **AlignPhase** and the waveforms on the oscilloscope will restore the current phase deviation of the two channels.

8. Modulation

Press **Modulation** to turn the modulation function on or off. For detailed

information about modulation function, please refer to "[Modulation](#)".

9. To set impedance

Press **Impedance** to set the output impedance of the current signal, "HighZ" and "50Ω" can be selected.

To Output Arbitrary Waveform

DS2000A allow users to define arbitrary waveforms and to save them to the internal or external memory. The internal memory can store 10 arbitrary waveforms at most. 1 to 16384 points can be included in the user-defined waveforms, namely 1 pts to 16 kpts. Press **Src1 Setup** to enter the waveform setting interface. Press **Wave** to select "Arb", at this point, you can edit arbitrary waveforms.

1. Output

Press **Output** to turn the signal output on or off.

2. To set frequency

Press **Frequency** to set the frequency of the current signal and the range available is from 100 mHz to 1 MHz.

Method one:

Rotate  directly to set the desired frequency value.

Method two:

Press  to input desired parameter values and adjust directly using the pop-up numeric keyboard.

3. To set amplitude

Press **Amplitude** to set the amplitude of the current signal and the range available is from 20 mVpp to 5Vpp (when the impedance is "HighZ") or from 10 mVpp to 2.5 Vpp (when the impedance is "50 Ω").

Method one:

Rotate  directly to set the desired amplitude value.

Method two:

Press  to input desired parameter values and adjust directly using the pop-up numeric keyboard.

4. To set the DC offset voltage

Press **Offset** to set the DC offset of the current signal and the range available is from "-2.5 V + the amplitude value currently set/2" (when the impedance is "HighZ") to "2.5 V + the amplitude value currently set/2" (when the impedance is "50 Ω").

Rotate  directly to set the desired DC offset value.

Method two:

Press  to input desired parameter values and adjust directly using the pop-up numeric keyboard.

The offset value is only retained three significant figures. For example, when the amplitude is set to 10 mV (the impedance is 50 Ω), the offset range calculated is -1.245 V to 1.245 V, but the actual offset range is -1.24 V to 1.24 V.

5. To set the start phase

Press **Start** Phase to set the start phase of the current signal and the range available is from 0° to 360°.

Method one:

Rotate  directly to set the desired start phase.

Method two:

Press  to input desired parameter values and adjust directly using the pop-up numeric keyboard.

6. Align phase

Press **AlignPhase** to re-configure the two channels and enable the signal source to output with specified frequency and phase. For two signals whose frequencies are the same or in multiple, this operation will align their phase. Use the oscilloscope to sample and display the waveforms of the two channels and you will see that the phase of the two waveforms shown on the oscilloscope changed. At this point, press **AlignPhase** and the waveforms on the oscilloscope will restore the current phase deviation of the two channels.

7. Select waveform

Select the arbitrary waveform stored in the internal or external memories. For detailed information please refer to "[To Select Waveform](#)".

8. Create waveforms

Users can create defined waveform. For detailed information please refer to "[To Create Waveform](#)".

9. Edit waveform

Edit the arbitrary waveforms already stored. For detailed information please refer to "[To Edit Waveforms](#)".

10. Modulation

Press **Modulation** to turn the modulation function on or off. For detailed information about modulation function, please refer to "[Modulation](#)".

11. To set impedance

Press **Impedance** to set the output impedance of the current signal, "HighZ" and "50Ω" can be selected.

The following will introduce how to "[To Select Waveform](#)", "[To Create Waveform](#)", and "[To Edit Waveforms](#)".

To Select Waveform

Users can select arbitrary waveforms stored in the internal memory to output. Press **Select** → **Load** and use  to select desired waveform. You also can edit the waveform currently selected and please refer to the instruction of "[To Edit Waveforms](#)".

To Create Waveforms

Users can create arbitrary waveforms according to their need. Press **Create** to enter the waveform creation interface.

1. To set the number of initial points

When creating a new waveform, the waveform editor will automatically create a waveform with two points. By default, point 1 is located at 0 s and point 1 is located at half of the specified period.

Press **InitPoint** and use  to set the initial points of the new waveform and the arbitrary waveform points can be up to 16384 (16 kpts).

2. Interpolation

Press **Interp** to turn the interpolation between the defined waveform points on or

off.

- **ON:** the waveform editor will connect the two points with a straight line.

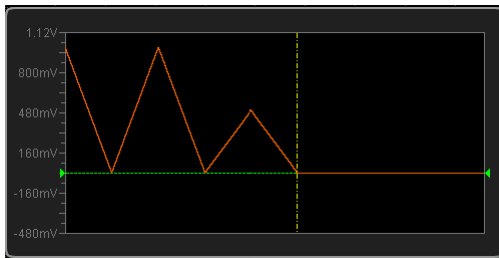

- **OFF:** the waveform editor will hold a constant voltage level between two points and create a step waveform.

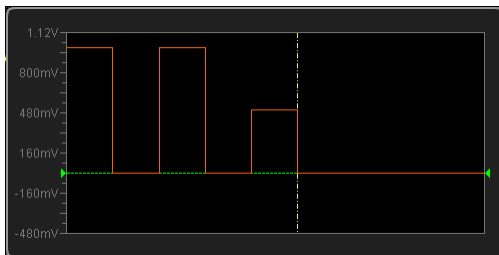

3. Zoom

Press **Zoom** to turn the zoom function on or off.

- **ON:** only displays the current point in the middle of the waveform editor window.
- **OFF:** displays all the initial points in the waveform editor window.

4. Current point

Press **CurPoint** and use  to set the desired points currently edited and the range available is from 1 to the initial points.

Method one:

Rotate  directly to set the desired points currently edited.

Method two:

Press  to input desired parameter values and unist directly using the pop-up numeric keyboard.

5. Voltage

Press **Voltage** to set the voltage value of the current point and the range available is from -2.5 V to +2.5 V.

Method one:

Rotate  directly to set the desired voltage value.

Method two:

Press  to input desired parameter values and adjust directly using the pop-up numeric keyboard.

6. Time

Press **Time** to set the duration time of the current point and this setting is limited by the duration times of the previous point and the next point. The point 1 is fixed at 0 s.

7. Insert

Press **Insert** to insert a new point at the middle position of the current edited point and the next edited point.

8. Delete

Press **Delete** to delete the current point from waveform and connect the remaining points using the current interpolation method. Note that point 1 can not be deleted.

9. Apply

Press **Apply** to apply the waveform currently edited.

10. Save

Press **Save** to enter the files store interface. Please refer to the instruction of "[13 Store and Recall](#)" to save the waveform files currently created in the internal or external memory in ".arb" format. The internal memory of the instrument can store 10 arbitrary waveforms (LocalArb.arb), if the current position exist a file, the original file will be overwritten. You can output the arbitrary waveforms saved in the internal or external memory and for the specified operation, please refer to the instruction of "[To Select Waveform](#)".

To Edit Waveforms

Users can edit the waveforms which have been already saved. Press **Edit** to enter the waveform editing interface.

1. Interpolation

Press **Interp** to turn the interpolation between the defined waveform points on or off.

- **ON**: the waveform editor will connect the two points with a straight line.
- **OFF**: the waveform editor will hold a constant voltage level between two points and create a step waveform.

2. Zoom

Press **Zoom** to turn the zoom function on or off.

- **ON**: only displays the current point in the middle of the waveform editor window.
- **OFF**: displays all the initial points in the waveform editor window.

3. Current point

Press **CurPoint** and use  to set the desired points currently edited and the range available is from 1 to the initial points.

Method one:

Rotate  directly to set the desired points currently edited.

Method two:

Press  to input desired parameter values and unist directly using the pop-up numeric keyboard.

4. Voltage

Press **Voltage** to set the voltage value of the current point and the range available is from -2.5 V to +2.5 V.

Method one:

Rotate  directly to set the desired voltage value.

Method two:

Press  to input desired parameter values and unist directly using the pop-up numeric keyboard.

5. Time

Press **Time** to set the duration time of the current point and this setting is limited by the duration times of the previous point and the next point. The point 1 is fixed at 0 s.

6. Insert point

Press **Insert** to insert a new point at the middle position of the current edited point and the next edited point.

7. Delete point

Press **Delete** to delete the current point from waveform and connect the remaining points using the current interpolation method. Note that point 1 can not be deleted.

8. Apply

Press **Apply** to apply the waveform currently edited.

9. Save

Press **Save** to enter the files store interface. Please refer to the instruction of "[13 Store and Recall](#)" to save the waveform files currently created in the internal or external memory in ".arb" format. The internal memory of the instrument can store 10 arbitrary waveforms (LocalArb.arb). If the current position exist a file, the original file will be overwritten. You can output the arbitrary waveforms saved in the internal or external memory and for the specified operation, please refer to the instruction of "[To Select Waveform](#)".

Modulation

The signal source built-in the DS2000A series oscilloscope supports AM and FM modulations. The modulated waveform consists of carrier waveform and modulating waveform. The carrier waveform can be the signal outputted from the signal source and the modulating waveform can be sine, square, ramp and noise signal which built-in the signal source.

Press **Modulation** to turn the modulation function on or off.

1. To select the modulation type

Press **Mod.Type** set the modulation type of the current signal.

Amplitude modulation: the amplitude of the carrier waveform varies with the amplitude of the modulating waveform.

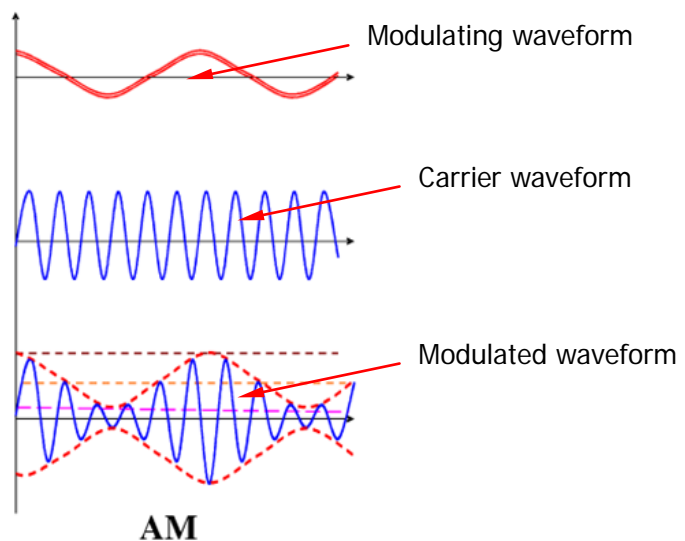

After AM is selected, you can set the frequency of the modulating waveform and the AM modulation depth:

Frequency: press **Frequency** to set the frequency of the modulating waveform and the range available is from 1 Hz to 50 kHz. For the setting method, please refer to the instruction of the ["To set frequency"](#).

Modulation depth: modulation depth is expressed as a percentage that

denotes the amplitude variation degree. Press Depth to set AM modulation depth and the range available is from 0% to 120%. In 0% modulation, the output amplitude is half of the carrier waveform amplitude; in 100% modulation, the output amplitude is equal to the carrier waveform amplitude; when the modulation is larger than 100%, the envelope distortion will be generated and the actual circuit must be avoided. At this point, the output amplitude would not be exceeded 5 Vpp (the impedance is 50 Ω).

Frequency modulation: the frequency of the carrier waveform varies with the amplitude of the modulating waveform.

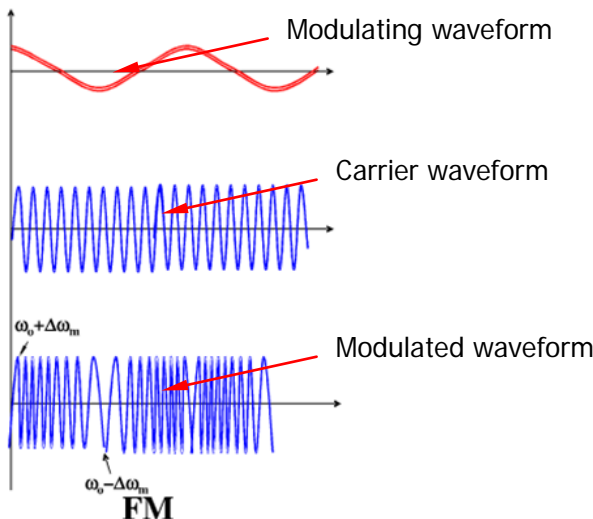

After FM is selected, you can set the frequency of the modulating waveform and the FM modulation frequency:

Frequency: press **Frequency** to set the frequency of the modulating waveform and the range available is from 1 Hz to 50 kHz. For the setting method, please refer to the instruction of the ["To set frequency"](#).

Deviation: press **Deviation** to set the deviation of modulating waveform frequency relative to the carrier waveform frequency and the range available is from 0 Hz to the carrier waveform frequency currently set.

2. To select modulating waveform

Press **Shape** to select Sine, Square, Ramp and Noise as the modulating waveform.

Chapter 13 Store and Recall

Users can save the current settings, waveforms, screen image and parameter of the oscilloscope in internal memory or external USB mass storage device (such as USB storage device) in various formats and recall the stored traces, settings or waveforms when needed.

The contents of this chapter:

- [Storage System](#)
- [Storage Type](#)
- [Internal Storage and Recall](#)
- [External Storage and Recall](#)
- [Disk Management](#)
- [Factory](#)

Storage System

Press **Storage** to enter the store and recall setting interface.

This oscilloscope provides a USB Host interface at the front panel to connect USB storage device for external storage and the internal memory capacity (Local Disk) is 90.5 MByte. The USB storage device connected is marked as "Disk D".

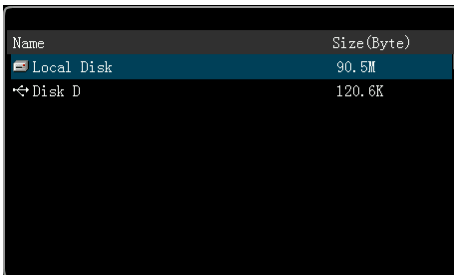

Name	Size(Byte)
Local Disk	90.5M
Disk D	120.6K

Storage Type

Press **Storage** → **Storage** to select the desired storage type. The default is "Picture". The storage and recall descriptions of each type are as follows.

1. Picture

Save the screen image in external memory in ".PNG", ".BMP8", ".BMP24", ".JPEG" or ".TIFF" format. You can specify the file name and saving directory and save the corresponding parameter file (.txt) under the same directory using the same file name and the function of this parameter file is the same to the [Parameters](#). The recall of image and parameter files is not supported.

After selecting this type:

Press **Pic Type** to select the desired storage format.

Press **Para.Save** to enable or disable the parameter save function.

One-key Bitmap Saving

After a USB storage device is connected, press  at the front panel to quickly save the current screen image under the root directory of the USB storage device in "png" format.

2. Traces

Save the waveform data in external memory in ".trc" format. The data of all the channels turned on can be saved in the same file. At recall, the data will be displayed on the screen directly.

3. Waveforms

Save the waveform data in external memory in ".wfm" format. The stored files contain the waveform data of the two analog channels and the main setting information of the oscilloscope and all the data can be recalled.

4. Setups

Save the settings of the oscilloscope in internal or external memory in ".stp" format. The stored settings can be recalled.

5. CSV

Save the waveform data displayed on the screen or of the specified channels in

external memory in a single ".csv" file. You can specify the file name and the saving directory and save the corresponding parameter file (.txt) under the same directory using the same file name the function of this parameter file is the same to the [Parameters](#). The recall of CVS and parameter files is not supported.

After selecting this type:

Press **DataSrc** to select "Screen" or "Memory". After selecting "Memory", press **Channel** to select the desired channel (note that only channels currently enabled can be selected).

Press **Param** to enable or disable the parameter save function.







6. Parameters

Save the waveform parameters displayed on the screen in external memory in ".txt" format. The parameters include the current system informations (such as model, firmware version and software version and so on) and the current relative settings information (such as vertical system, horizontal system and normal trigger system).



Internal Storage and Recall

Internal storage and recall support “Setups” in **Storage**. In the following part, the storage and recall method and procedures are introduced.

1. Save the specified oscilloscope setting in internal memory.

- 1) Connect the signal to the oscilloscope and obtain stable display.
- 2) Press **Storage** → **Storage** to select “Setups”, press **Save** and use  to select “Local Disk” (appears as blue shading) and press down  to open the local disk.
- 3) Press New File to create a file name using the pop-up keyboard and for specific operations please refer to the instruction of [“To Create a New File or Folder”](#). If the internal memory has saved files in this type, use  to select the file and **Save** and **Delete** are illuminated, at this point, press **Save** to execute the saving operation, the original file can be overwritten or be deleted by pressing **Delete**. Use  to select  and then press down  to return to the previous directory.



2. Load the specified type of file in internal memory.

- 1) Press **Storage** → **Storage** to select “Setups” and then press **Load** and use  to select “Local Disk” and then press down  to open the local disk.
- 2) If the internal memory has saved files in this type, use  to select the desired file to load and press **Load** to load the file selected.





External Storage and Recall

Before using external storage and recall, make sure that the USB storage device is connected correctly. External storage supports all the types of files in **Storage** but in recall, "Picture", "CSV" and "Param" are not supported.



1. Save the specified type of file in the external USB storage device.

- 1) Connect the signal to the oscilloscope and obtain stable display.
- 2) Press **Storage** → **Storage** to select "Traces", press **Save** and use  to select "Disk D" and press down  to open the USB storage device.
- 3) Use  to select the desired storage position. The file can be stored under the root directory or in a certain folder under the root directory of the USB storage device.

Note: press **NewFolder** to create a new folder and for specific operation, please refer to the instruction of "[To Create a New File or Folder](#)".

- 4) After the storage position is selected, press **New File** to create a new file name using the pop-up keyboard, for detail operations, please refer to the instruction of "[To Create a New File or Folder](#)". If the internal memory has saved files in this type, use  to select the file and **Save** and **Delete** are illuminated, at this point, press **Save** to execute the saving operation, the original file can be overwritten or be deleted by pressing **Delete**. Use  to select  and then press down  to return to the previous directory.
- 5) Press **OK** to execute the saving operation.

2. Load the specified type of file in the external USB storage device.

- 1) Press **Storage** → **Storage** to select "Traces" and then press **Load** and use  to select "Disk D" and then press down  to open the local disk.
- 2) If the USB storage device has saved files in this type, use  to select the desired file to load and press **Load** to load the file selected.

Disk Management

Press **Storage** → **DiskManage** to turn on the disk management interface as shown in the figure below and use **↶** to select the desired disk. The disk currently selected is displayed in blue shading and press down **↵** to open the disk selected.

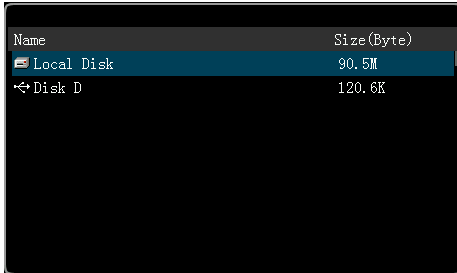

Execute the following operations through the disk management menu:

- [To Select File Type](#)
- [To Create a New File or Folder](#)
- [To Delete a File or Folder](#)
- [To Rename a File or Folder](#)
- [To Clear the Local Memory](#)

To Select File Type

Except the file types in **Storage**, the oscilloscope can also display, save or read some files for advanced applications such as mask file of the Pass/Fail test (*.pf), waveform record file (*.rec), upgrade file (.rgl), parameter file (*.txt) and reference waveform file (*.ref).

Press **Storage** → **DiskManage** → **File Type** to select the desired file type. The default is "*. *". Under the current directory, only files of which the suffix of the file name matches with the file type selected will be displayed in the current disk.

To Create a New File or Folder

This operation of folder is only valid in external storage. Before using external disk, make sure that the USB storage device is connected correctly.



First, press **Storage** → **Disk.Manage** and use  to select and open the external disk ("Disk D"). Then, select the desired file type. Last, select the desired directory under which to create a new file or folder. The default is the root directory of the USB storage device.

Then, press **New File** or **New Folder** to turn on the interface as shown in the figure below.



This oscilloscope supports Chinese/English input method. The file name or folder name can contain letters, numbers, underscores, spaces and Chinese characters and the length of the characters is limited to 64 bytes. The following part introduces how to input a file name or folder name using Chinese/English input method.





Operation Tip

During the name input, use the menu softkeys to select different operation areas, then turn  to select the desired content and press down  to input the content selected.

English Input Method

For example, create a file or folder with the name "Filename".

1. Press **Keyboard**.

- 1) Use  to select English input method "En" and uppercase input state "Aa".
- 2) Use  to input the letter "F". If the input is wrong, press **Delete** to delete the character input.
- 3) Use  to select lowercase input state "Aa".
- 4) Use  to input the remaining letters "ilename".

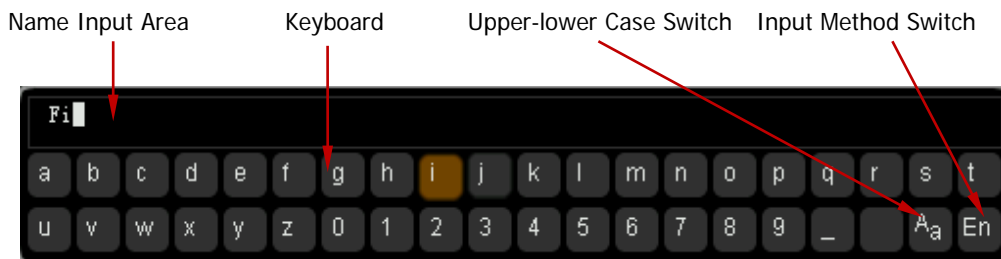



2. During the name input, you can press **Name** to select the "Name Input Area" and use  to move the cursor, then press **Delete** to delete the characters on the left of the cursor one by one.
3. After finishing the input, press **OK** and the oscilloscope will create a folder or a specified type of file with this name under the current directory.

Chinese Input Method

For example, create a file or folder with the name “文件名”.

1. Press **Keyboard**.



- 1) Use  to select Chinese input method “中”. Note that **Chinese** is added in the menu items at the right of the screen.
- 2) Use  to input the pinyin “wen”. If the input is wrong, press **Delete** to delete the pinyin input. After “wen” is input, a series of Chinese characters appear in the “Chinese Character Selecting Area”.
- 3) Press **Chinese** and use  to select and input “文”.
- 4) Use the same method to input “件” and “名”.





2. During the name input, you can press **Name** to select the “Name Input Area” and then press **Delete** to delete the Chinese characters on the left of the cursor one by one.
3. After finishing the input, press **OK** and the oscilloscope will create a folder or a specified type of file with this name under the current directory.

To Delete a File or Folder

Folder operation is valid only in external storage. Before using the external disk, make sure that the USB storage device is connected correctly.



1. Delete a file in internal memory.
 - 1) Press **Storage** → **DiskManage** and use  to select and open the local disk ("local Disk").
 - 2) Press **File Type** to select the desired type of file to delete (note that the file types of internal storage include "*.stp", "*.ref" and "*.pf").
 - 3) Use  to select the desired file to delete.
 - 4) Press **Delete** → **OK** to delete the file selected.

2. Delete a file or folder in external memory.

Press **Storage** → **DiskManage** and use  to select and open the external disk ("Disk D"). Use  to select the file (or folder) to be deleted and then press **Delete** → **OK** to delete the selected file (or folder).

To Rename a File or Folder

Rename operation is valid only in external storage. Before using the external disk, make sure that the USB storage device is connected correctly.

Press **Storage** → **DiskManage** and use  to select and open the external disk ("Disk D"). Use  to select the desired file or folder to rename and then press **Rename** to turn on the rename interface. For specific operations, please refer to the descriptions in "[To Create a New File or Folder](#)".

To Clear the Local Memory

Press **Storage** → **DiskManage** and select "Local Disk", then press **FlashClear** → **OK** to delete all the files stored in the local memory. At the same time, the instrument will be resotred to the default setting.

Factory

Press **Storage** → **Default** to return the oscilloscope to its factory state (refer to the table below).

Table 0-1 Factory

Parameter	Factory
<u>Horizontal Setting (HORIZONTAL)</u>	
<u>Vertical Setting (VERTICAL)</u>	
<u>Acquisition Setting (Acquire)</u>	
<u>Trigger Setting (TRIGGER)</u>	
<u>Display Setting (Display)</u>	
<u>Signal Source</u>	
<u>Cursor Setting (Cursor)</u>	
<u>Storage Setting (Storage)</u>	
<u>Utility Function Setting (Utility)</u>	
<u>Math Operation Setting (MATH→Operation)</u>	
<u>Protocol Decoding (MATH→Decode1/Decode2)</u>	
<u>Reference Waveform Setting (REF)</u>	
Horizontal Setting (HORIZONTAL)	
Horizontal Time Base	1 μ s
Horizontal Offset	0 s
Delayed Sweep	OFF
Time Base Type	YT
Vertical Setting (VERTICAL)	
Vertical Scale	200 mV
Vertical Offset	0 V
CH1 Switch	ON
CH2 Switch	ON
CH3 Switch	ON
CH4 Switch	ON
Channel Coupling	DC
Bandwidth Limit	OFF
Probe Ratio	1X



Channel Invert	OFF
Amplitude Scale	Coarse
Channel Unit	[V]
Acquisition Setting (Acquire)	
Acquisition Mode	Normal
Sin(x)/x	OFF
Memory Depth	Auto
Trigger Setting (TRIGGER)	
Trigger Type	Edge
Source	CH1
Slope	Rising Edge
Trigger Mode	Auto
Trigger Coupling	DC
Trigger Holdoff	16ns
Noise Reject	OFF
Display Setting (Display)	
Display Type	Vectors
Persistence Time	Min
Waveform Intensity	50%
Screen Grid	
Brightness	50%
Signal Source	
Output	OFF
Status Display	OFF
Src1 Setup	
Wave	Sine
Output	OFF
Frequency	100 kHz
Amplitude	1.000 V
Offset	0.00 V
Start Phase	0.00°
Modulation	OFF

Src2 Setup	
Wave	Sine
Output	OFF
Frequency	100 kHz
Amplitude	1.000 V
Offset	0.00 V
Start Phase	0.00°
Modulation	OFF
Cursor Setting (Cursor)	
Mode	OFF
Manual	
Cursor Type	X
Source	CH1
Time Unit	s
CurA	-4*1μs
CurB	4*1μs
Track	
Cursor A	CH1
Cursor B	CH1
CurA	-4*1 μs
CurB	4*1 μs
Storage Setting (Storage)	
Storage Type	Picture
Utility Function Setting (Utility)	
I/O Setting	
Network Configuration Mode	DHCP, Auto IP
Sound	
Sound	OFF
Pass/Fail Test	
Enable Test	OFF
Source	CH1
Operate	OFF
X Mask	0.24 div

Y Mask	0.48 div
Statistic Display	OFF
Stop On Output	OFF
Output	Fail
Aux Output	OFF
System Setting	
Vertical Expansion	Ground
Power On Set	Default
Math Operation Setting (MATH→Operation)	
A+B	
Display	OFF
Source A	CH1
Source B	CH1
Offset	0 V
Scale	500 mV
A-B	
Display	OFF
Source A	CH1
Source B	CH1
Offset	0 V
Scale	500 mV
A*B	
Display	OFF
Source A	CH1
Source B	CH1
Offset	0 V
Scale	500 mU
A/B	
Display	OFF
Source A	CH1
Source B	CH1
Offset	0 V
Scale	500 mU
FFT	
Display	OFF

Source	CH1
Offset	0 dBV
Scale	500 mdBV
Center	5 MHz
Hz/Div	5 MHz
Scale	20 dBV
View	Half
Unit	dB/dBm
A&&B	
Display	OFF
Source A	CH1
Source B	CH1
Offset	0 U
Scale	500 mU
Threshold A	0 V
Threshold B	0 V
A B	
Display	OFF
Source A	CH1
Source B	CH1
Offset	0 U
Scale	500 mU
Threshold A	0 V
Threshold B	0 V
A ^ B	
Display	OFF
Source A	CH1
Source B	CH1
Offset	0 U
Scale	500 mU
Threshold A	0 V
Threshold B	0 V
!A	
Display	OFF
Source A	CH1
Source B	CH1

Offset	0 U
Scale	500 mU
Threshold A	0 V
intg	
Display	OFF
Source	CH1
Offset	0 U
Scale	1 μ U
diff	
Display	OFF
Source	CH1
Offset	0 U
Scale	2 MU
sqrt	
Display	OFF
Source	CH1
Offset	0 U
Scale	100 mU
Ig	
Display	OFF
Source	CH1
Offset	0 U
Scale	100 mU
In	
Display	OFF
Source	CH1
Offset	0 U
Scale	100 mU
exp	
Display	OFF
Source	CH1
Offset	0 U
Scale	100 mU
abs	
Display	OFF
Source	CH1

Offset	0 U
Scale	100 mU
Protocol Decoding (MATH→Decode1/Decode2)	
Decoder	Parallel
Decode	OFF
Format	ASC
Parallel	
Clock Channel	None
Edge	Rising Edge
Width	8
Bit X	0
Channel	CH1
RS232	
TX	CH1
Polarity	
Baud	9600
RX	OFF
Endian	LSB
Data	8
Stop	1
Parity	None
I2C	
SCLK	CH1
SDA	CH2
Address	Normal
SPI	
Mode	Timeout
CLK	CH1
MISO	OFF
MOSI	CH2
Edge	Rising edge
Polarity	
Timeout	20 μs
Width	8
Order	LSB

Configure	
Label	ON
Line	ON
Format	ON
Endian	ON
Width	ON
Data Src	Trace
Range	Full
Reference Waveform Setting (REF)	
Channel Setting	REF1
Current Channel	REF1
Source	CH1
Offset	0 μ V
Scale	200 mV
Color	Gray

Chapter 14 System Function Setting

The contents of this chapter:

- [Remote Interface Configuration](#)
- [System-related](#)

Remote Interface Configuration

DS1000Z can communicate with PC via LAN and USB buses. Please refer to the introduction below to configure the corresponding interface before using the remote interfaces.

LAN Setting

Press **Utility** → **IO Setting** → **LAN Conf.** to turn on the LAN setting interface. You can view the network connection status and configure the network parameters.

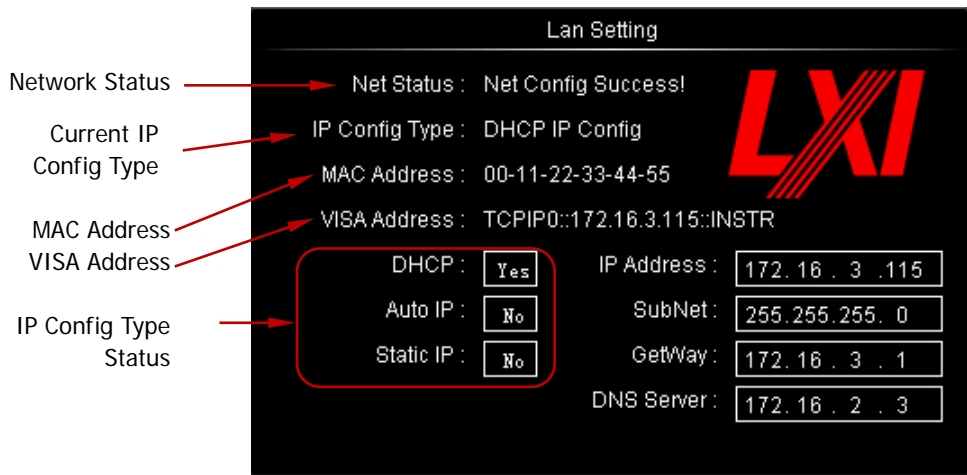



Network Status

Connect the oscilloscope to your local area network using the network cable. The network hole of the oscilloscope is at the rear panel. The oscilloscope will give different prompts according to the current network connection status.

- Net Config Success!
- Acquire IP...
- IP Conflict!
- Unconnected!
- DHCP Fail!
- Read Status Fail!



IP Configuration Type (DHCP)

The configuration type of the IP address can be DHCP, auto IP or static IP. In different IP configuration type, the configuration mode of the network parameters (such as the IP address) is different.



Press **Configure** and use  to select "DHCP". Then press down  to select this type. When DHCP type is valid, the DHCP server in the current network will assign the network parameters (such as the IP address) for the oscilloscope.



IP Configuration Type (Auto IP)

Press **Config Mode** and use  to select "Auto IP". Then press down  to select this type. When the auto IP type is valid, disable DHCP manually, **Gate** and **DNS** are added to the right side of the screen and users can define the gateway and DNS server address of the oscilloscope. In auto IP mode, the oscilloscope will get the IP address ranging from 169.254.0.1 to 169.254.255.254 and the subnet mask 255.255.0.0 automatically according to the current network configuration.

IP Configuration Type (Static IP)

Press **Config Mode** and use  to select "Static IP". Then press down  to select this type. When this type is valid, disable DHCP and auto IP manually, **IP Address**, **Mask**, **Gate** and **DNS** are added to the right of the screen. At this point, users can define their own network parameters (such as the IP address) of the oscilloscope.

1. Set the IP Address

The format of IP address is nnn.nnn.nnn.nnn; wherein, the range of the first nnn is from 0 to 223 (except 127) and the ranges of the other three nnn are

from 0 to 255. You are recommended to ask your network administrator for an IP address available.

Press **IP Address** and use  to input the desired IP address. This setting will be saved in the non-volatile memory and if [Power-on Recall](#) is set to "Last", **DHCP** and **Auto IP** will be "Off" and the oscilloscope will load the preset IP address automatically at the next power-on.

2. Set the Subnet Mask.

The format of the subnet mask is nnn.nnn.nnn.nnn; wherein, the range of the nnn is from 0 to 255. You are recommended to ask your network administrator for a subnet mask available.

Press **Mask** and use  to input the desired subnet mask. This setting will be saved in the non-volatile memory and if [Power-on Recall](#) is set to "Last", **DHCP** and **Auto IP** will be "Off" and the oscilloscope will load the preset subnet mask automatically at the next power-on.

Set the Gate

You can set this parameter In **Auto IP** and **Static IP** mode.

The format of the gate is nnn.nnn.nnn.nnn; wherein, the range of the first nnn is from 0 to 223 (except 127) and the ranges of the other three nnn are from 0 to 255. You are recommended to ask your network administrator for a gate address available.

Press **Gate** and use  to input the desired gate address. This setting will be saved in the non-volatile memory and if [Power-on Recall](#) is set to "Last", **DHCP** and **Auto IP** will be "Off" and the oscilloscope will load the preset gate address automatically at the next power-on.

Set the Domain Name Server

You can set this parameter In **Auto IP** and **Static IP** mode.

The address format of the domain name server is nnn.nnn.nnn.nnn; wherein, the range of the first nnn is from 0 to 223 (except 127) and the ranges of the other three nnn are from 0 to 255. You are recommended to ask your network administrator for an address available.

press **DNS** and use  to input the desired address. Generally, users do not need to set the DNS, therefore this parameter setting can be ignored.

Tips

- When the three IP configuration types are all turned on, the priority of the parameter configuration from high to low is "DHCP", "Auto IP" and "Static IP".
- The three IP configuration types can not be all turned off at the same time.

Apply the Network Parameter Setting

Press **Apply** to validate the current network parameter setting.

Initialize the Network Parameters

Press **Initialize** to return the network parameters to the default state.

MAC Address

For each oscilloscope, the MAC address is unique. When attributing IP address for the oscilloscope, the MAC address is usually used to identify the instrument.

VISA Address

Display the VISA address currently used by the oscilloscope.

USB Device



This oscilloscope can communicate with PC or PictBridge printer via the **USB Device** interface at the rear panel.

Press **Utility** → **IO Setting** → **USB Device** and the default is “Computer”, at this point, the oscilloscope can communicate with the PC.

System-related



Sound

When the sound is enabled, you can hear the sound of the beeper when you press a function key or a menu softkey or when the prompt message pops up.

Press **Utility** → **Beeper** to select  (on) or  (off). The default is off. When the sound is turned on, a trumpet icon  will be displayed at the lower right corner of the screen.

Language

This oscilloscope supports multiple language menus, Chinese/English help and prompt messages.

Press **Utility** → **Language** and use  to select the desired language. Then press down  to select the language.

System Information

Press **Utility** → **System** → **System Info.** to view the version information of your oscilloscope. The system information contains the following contents as shown in the figure below.

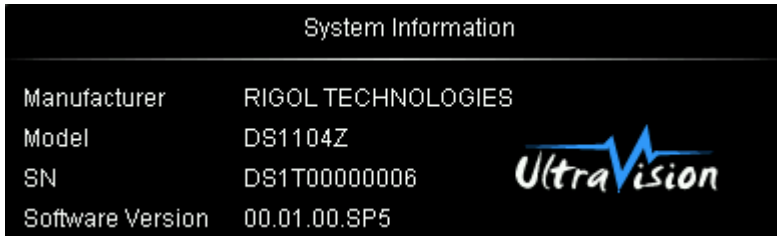

System Information	
Manufacturer	RIGOL TECHNOLOGIES
Model	DS1104Z
SN	DS1T00000006
Software Version	00.01.00.SP5

Power-on Recall

You can set the system configuration to be recalled when the oscilloscope is powered on again after power-off.

Press **Utility** → **System** → **Power On Set** to select "Last" (default) or "Default".

- Last: return to the setting of the system at last power-off.
- Default: return to the factory setting of the system.

Self-calibration

The self-calibration program can quickly make the oscilloscope reach the best working state to get the most precise measurement values. You can perform self-calibration at any time especially when the change of the environment temperature is up to or more than 5 °C. Make sure that the oscilloscope has been warmed up or operated for more than 30 minutes before the self-calibration.

Disconnect all the input channels and then press **Utility** → **Self-Cal** and the self-calibration interface as shown in the figure below is displayed.



Press **Start** and the oscilloscope will start to execute the self-calibration program. Press **Exit** to give up the self-calibration operation at any time and return to the previous menu.

Note: most of the keys are disabled during the self-calibration.

Option Management

This oscilloscope provides multiple options to fulfill your measurement requirements. Please contact your **RIGOL** sales representative or **RIGOL** technical support to order the corresponding options. You can view the options currently installed on the oscilloscope or activate the newly bought option serial number through this menu.

Press **Utility** → **Options** → **Installed** to view the options currently installed on the oscilloscope. Press **Setup** to enter the serial number activation operation menu.

- Editor: press this softkey to turn on the serial number input interface as shown in the figure below. Use ↻ to select the characters on the virtual keyboard and press down the knob to input the character.

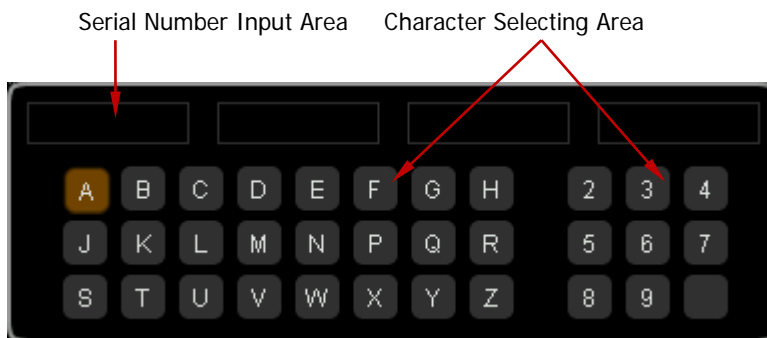

- Backspace: press this softkey to delete the characters in the "Serial Number Input Area" from the right to the left.
- Clear: press this softkey to clear all the characters in the "Serial Number Input Area".
- Apply: press this softkey and the oscilloscope will activate the corresponding option using the serial number currently input.

Chapter 15 Remote Control

The oscilloscope can be controlled remotely mainly through the following two methods.

User-defined programming

Users can program and control the oscilloscope by using the SCPI (Standard Commands for Programmable Instruments) commands. For more information about the commands and programming, refer to the Programming Guide.

Use PC software provided by RIGOL or other manufacturers

Users can use the PC software **Ultra Sigma** of **RIGOL, Measurement & Automation Explorer** of **NI** (National Instruments Corporation) or **Agilent IO Libraries Suite** of **Agilent** (Agilent Technologies, Inc.) to send commands to control the oscilloscope remotely.

This oscilloscope can communicate with PC through USB and LAN instrument buses. This chapter will give a detailed introduction of how to use **Ultra Sigma** to control DS1000Z remotely through various interfaces. For the **Ultra Sigma** software, please contact **RIGOL** salesmen or technical support.

The contents of this chapter:

- [Remote Control via USB](#)
- [Remote Control via LAN](#)

Remote Control via USB

1. Connect the device

Connect the oscilloscope (USB DEVICE) with your PC using a USB cable.

2. Install the USB driver

This oscilloscope is a USBTMC device. Assuming that your PC has already been installed with **Ultra Sigma**, after you connect the oscilloscope to the PC and turn both on for the first time (the oscilloscope is automatically configured to USB interface), the **New Hardware Wizard** as shown in the figure below is displayed on the PC. Please install the "USB Test and Measurement Device" driver following the directions in the wizard. The steps are as follows.

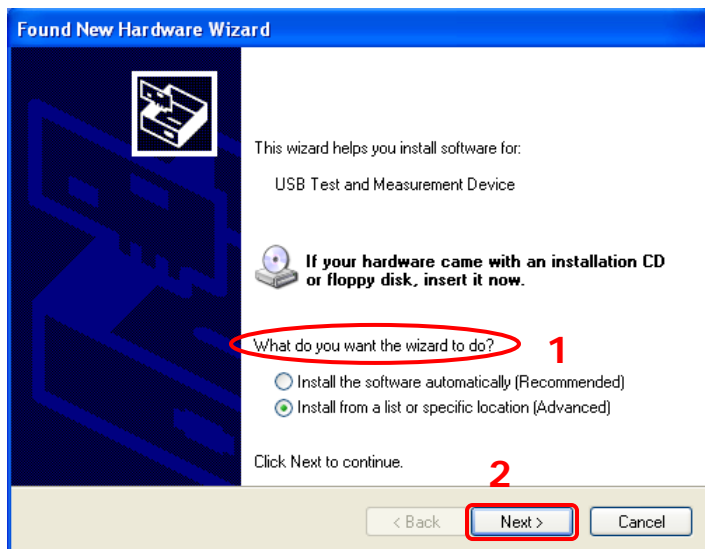

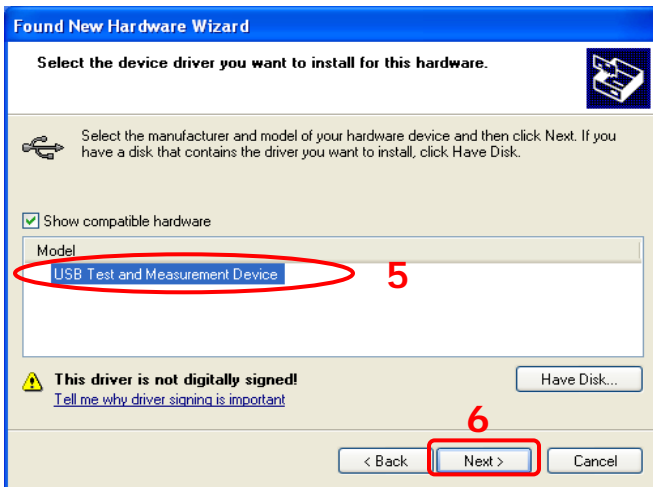
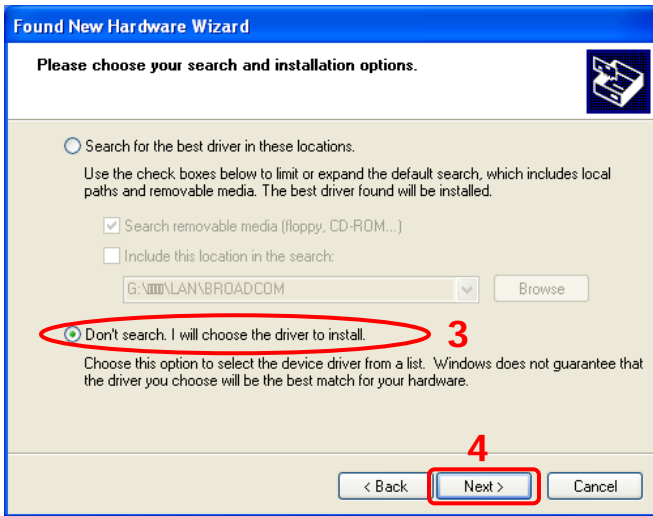

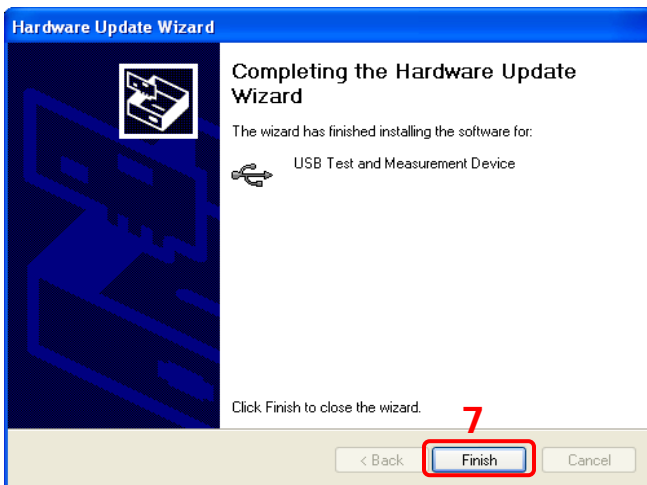
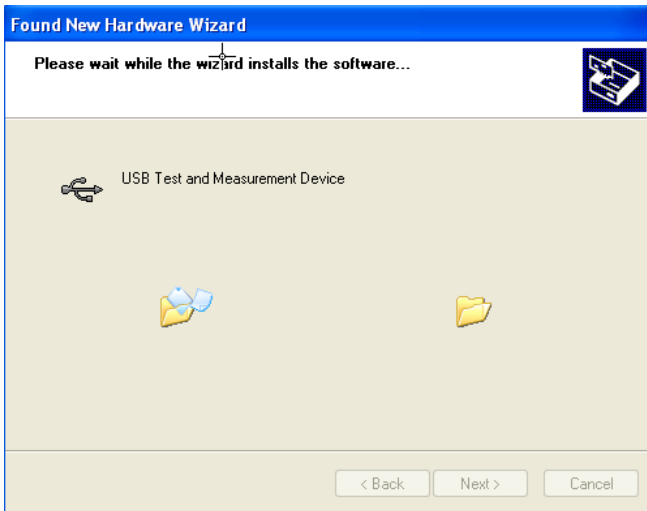

3. Search device resource

Start up the **Ultra Sigma** and the software will automatically search for the oscilloscope resources currently connected to the PC. You can also click

USB-TMC to search the resources. During the search, the status bar of the software is as shown in the figure below.



4. View the device resource

The resources found will appear under the “RIGOL Online Resource” directory and the model number and USB interface information of the instrument will also be displayed as shown in the figure below.

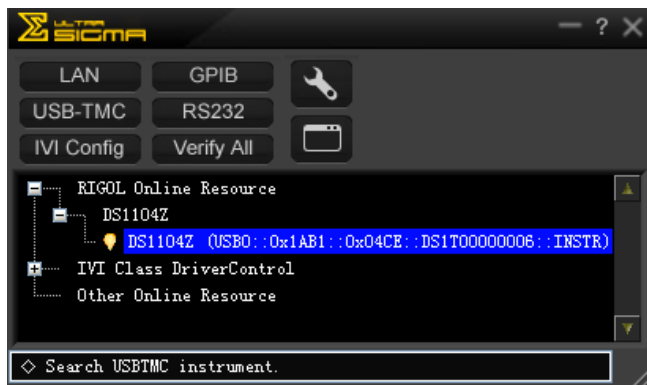

5. Communication test

Right click the resource name

“DS1104Z (USB0::0x1AB1::0x04CE::DS1T000000006::INSTR)” to select “SCPI Panel Control” to turn on the remote command control panel (as shown in the figure below) through which you can send commands and read data.

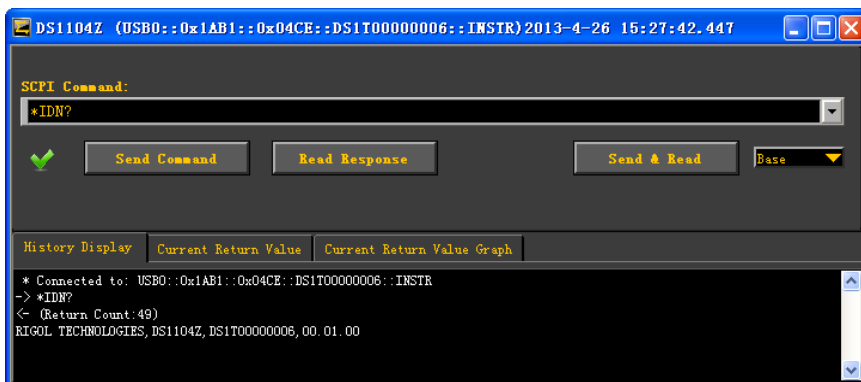

Remote Control via LAN

1. Connect the device

Connect the oscilloscope to your LAN using a network cable.

2. Configure network parameters

Configure the network parameters of the oscilloscope according to the description in "[LAN Setting](#)".

3. Search device resource

Start up the **Ultra Sigma** and click **LAN**. The window as shown in the figure below is displayed. Click **Search** (as shown in Figure (a)) and the software searches for the oscilloscope resources currently connected to the LAN and the resources found are displayed at the right of the window. As shown in Figure (b), select the desired resource name and click **OK** to add it. Note that if you want to remove the unwanted resource, select the resource name and click **Remove** (as shown in Figure (c)).

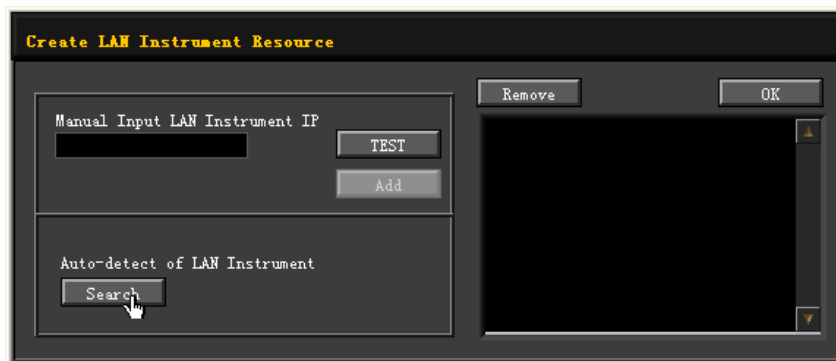

Figure (a)

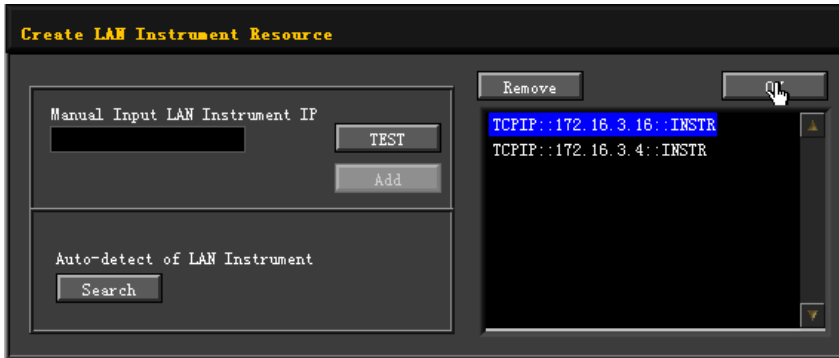

Figure (b)

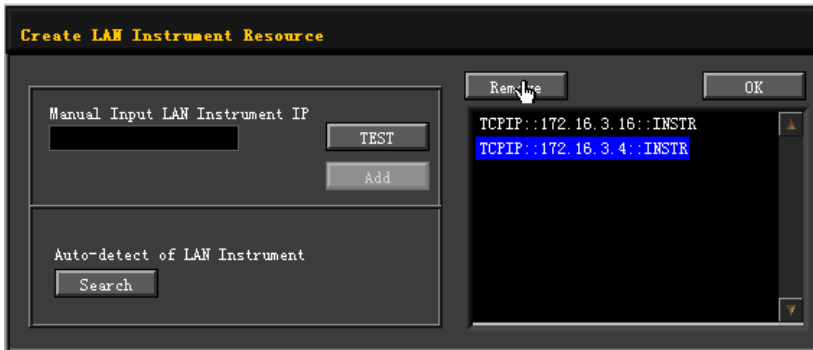

Figure (c)

4. View device resource

The resources found will appear under the “RIGOL Online Resource” directory as shown in the figure below.



5. Communication test

Right click the resource name “DS1104Z (TCPIP::172.16.3.16::INSTR)” to select “SCPI Panel Control” to turn on the remote command control panel (as shown in the figure below) through which you can send commands and read data.

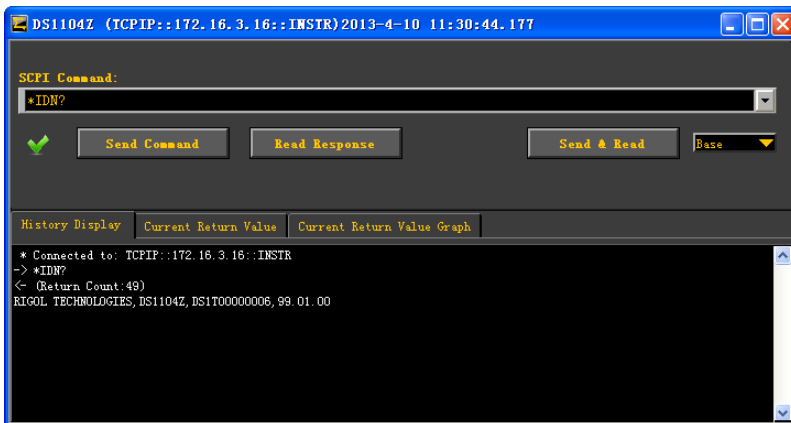

6. Load LXI webpage

As this oscilloscope conforms to LXI-C standards, you can load LXI webpage through **Ultra Sigma** (right-click the resource name and select LXI-Web; or directly input the IP address in the browser). Various important information about the oscilloscope (including the model number, manufacturer, serial number, description, MAC address and IP address) will be displayed on the webpage as shown in the figure below.



Chapter 16 Troubleshooting

The commonly encountered failures and their solutions are listed below. When you encounter those problems, please solve them following the corresponding steps. If the problem remains still, please contact **RIGOL** and provide your device information (**Utility** → **System** → **System Info**).

1. The screen is still dark (no display) after power on:

- (1) Check if the power is correctly connected.
- (2) Check whether the fuse is burned out. If the fuse needs to be changed, please use the specified fuse.
- (3) Restart the instrument after finishing the above inspections.
- (4) If it still does not work correctly, please contact **RIGOL**.

2. The signal is sampled but no waveform of the signal is displayed:

- (1) Check if the probe is correctly connected to the oscilloscope and the item under tested.
- (2) Check if there are signals generated from the item under test (you can connect the probe compensation signal to the problematic channel to determine which has problems, the channel or the item under test).
- (3) Resample the signal.

3. The voltage amplitude measured is greater or lower than the actual value (note that this failure usually only occurs when probe is used):

Check whether the attenuation coefficient of the channel complies with the attenuation ratio of the probe.

4. There is waveform display but not stable:

- (1) Check the trigger signal source: check whether the **Source** item at the trigger panel complies with the signal channel actually used.
- (2) Check the trigger type: general signals should use "Edge" trigger and video signal should use "Video" trigger. Only when the proper trigger type is used, can the waveform be displayed stably.
- (3) Check the trigger level: adjust the trigger level to the middle position of the signal.

(4) Change the trigger holdoff setting.

5. No display after pressing **RUN/STOP:**

Check if the **MODE** at the front panel TRIGGER control area is on “Normal” or “Single” and if the trigger level exceeds the waveform range. If yes, set the trigger level to the middle or set the **MODE** to “Auto”.

Note: using **AUTO** could automatically finish the above setting.

6. The display of waveform is ladder-like:

- (1) The horizontal time base might be too low. Increase the horizontal time base to increase the horizontal resolution and improve the display.
- (2) If **Type** is “Vectors”, the lines between the sample points may cause ladder-like display. Set **Type** to “Dots” to solve the problem.

7. Fail to connect PC through USB:

- (1) Check if the USB data cable is correctly connected to the oscilloscope and PC.
- (2) Check if the USB data is in good condition and if needed, restart the oscilloscope.

8. The USB disk can not be recognized:

- (1) Check if the USB disk can work normally.
- (2) Make sure that the USB disk being used is flash type. This oscilloscope does not support hardware type USB disk.
- (3) Make sure if the capacity of the USB disk is too large. It is recommended that the capacity of the USB disk being used with this oscilloscope is no larger than 8 GBytes.
- (4) Restart the instrument and then insert the USB disk to check it.
- (5) If the USB disk still can not be used normally, please contact **RIGOL**.

Chapter 17 Specifications

All the specifications are guaranteed except parameters marked with “Typical” and the oscilloscope needs to operate for more than 30 minutes under the specified operation temperature.

Sample

Sample Mode	Real-time sample
Real-time Sample Rate	1 GSa/s (single-channel) 500 MSa/s (dual-channel) 250 MSa/s (four-channel)
Averaging	After both the channels finish N samples at the same time, N can be 2, 4, 8, 16, 32, 64, 128, 256, 512, 1024.
High Resolution	The highest resolution is 12 bit
Peak Detection	4 ns
Memory Depth	Single-channel: Auto, 12k pts, 120k pts, 1.2M pts, 12M pts and 24M pts (option) are available Dual-channel: Auto, 6k pts, 60k pts, 600k pts, 6M pts and 12M pts (option) are available Four-channel: Auto, 3k pts, 30k pts, 300k pts, 3M pts and 6M pts (option) are available

Input

Number of Channels	four-channel
Input Coupling	DC, AC or GND
Input Impedance	(1 MΩ±2%) (13 pF±3 pF)
Probe Attenuation Coefficient	0.01X-1000X, 1-2-5 step
Max Input Voltage (1MΩ)	Maximum input voltage of the analog channel CAT I 300 Vrms, CAT II 100 Vrms, transient overvoltage

	1000 Vpk With RP2200 10:1 probe: CAT II 300 Vrms
--	---

Horizontal

Time Base Scale	5 ns/div to 50 s/div
Time Base Accuracy ^[1]	$\leq \pm 25$ ppm
Time Base Drift	$\leq \pm 5$ ppm/year
Max Delay Range	Pre-trigger (negative delay): $\geq 1/2$ screen width Post-trigger (positive delay): 1 s to 5,000 s
Time Base Mode	Y-T, X-Y, Roll, Delayed
Number of X-Ys	1 path
Waveform Capture Rate ^[2]	30,000 wfms/s (dots display)

Vertical

Bandwidth (-3dB)	DS1104Z: DC to 100 MHz DS1074Z: DC to 70 MHz
Single Bandwidth	DS1104Z: DC to 100 MHz DS1074Z: DC to 70 MHz
Vertical Resolution	8 bit
Vertical Scale	1 mV/div to 10 V/div
Offset Range	1 mV/div to 499 mV/div: ± 2 V 500 mV/div to 10 V/div: ± 100 V
Bandwidth Limit ^[1]	20 MHz
Low Frequency Response (AC coupling, -3dB)	≤ 5 Hz (on BNC)
Rise Time ^[1]	DS1104Z: 3.5 ns DS1074Z: 5 ns
DC Gain	<10 mV: $\pm 4\%$ full scale

Accuracy ^[3]	≥10 mV: ±3% full scale
DC Offset Accuracy	±0.1 div ± 2 mV ± 1% offset
Channel to Channel Isolation	DC to maximum bandwidth: >40 dB

Trigger

Trigger Level Range	±5 div from the center of the screen
Trigger Mode	Auto, Normal, Single
Holdoff Range	16 ns to 10 s
High Frequency Rejection ^[1]	75 kHz
Low Frequency Rejection ^[1]	75 kHz
Trigger Sensitivity ^[1]	1.0div (below 5mV or noise rejection is enabled) 0.3div (above 5mV and noise rejection is disabled)

Edge Trigger

Edge Type	Rising, Falling, Rising&Falling
-----------	---------------------------------

Pulse Trigger

Pulse Condition	Positive Pulse Width (greater than, lower than, within specified interval) Negative Pulse Width (greater than, lower than, within specified interval)
Pulse Width Range	8 ns to 10 s

Runt Trigger

Pulse Condition	None, > (greater than), < (lower than), <> (within the specified interval)
Polarity	Positive, Negative
Pulse Width Range	8 ns to 4 s

Windows Trigger

Windows Type	Rising, Falling, Rising&Falling
Trigger Position	Enter, Exit, Time
Windows Time	8 ns to 10 s

Nth Edge Trigger

Edge Type	Rising, Falling
-----------	-----------------

Idle Time	16 ns to 10 s
Number of Edges	1 to 65535
Slope Trigger	
Slope Condition	Positive Slope (greater than, lower than, within specified interval) Negative Slope (greater than, lower than, within specified interval)
Time Setting	8 ns to 10 s
Video Trigger	
Signal Standard	Support standard NTSC, PAL and SECAM broadcasting standards Support 480P, 576P HDTV standards
Pattern Trigger	
Pattern Setting	H, L, X, Rising Edge, Falling Edge
Delay Trigger	
Edge Type	Rising, Falling
Delay Type	> (greater than), < (lower than), <> (within the specified interval), >< (outside the specified interval)
Delay Time	8 ns to 10 s
TimeOut Trigger	
Edge Type	Rising, Falling, Rising&Falling
TimeOut Value	16 ns to 10 s
Duration Trigger	
Pattern Setting	H, L, X
Trigger Condition	> (greater than), < (lower than), <> (within the specified interval)
Duration Time	8 ns to 10 s
Setup/Hold Trigger	
Edge Type	Rising, Falling
Data Pattern	H, L,X
Setup Time	8 ns to 1 s
Hold Time	8 ns to 1 s
RS232/UART Trigger	
Polarity	Normal, Invert
Trigger Condition	Start, Error, Check Error, Data
Baud	2400 bps, 4800 bps, 9600 bps, 19200 bps, 38400 bps, 57600

	bps, 115200 bps, User
Data Bits	5 bits, 6 bits, 7 bits, 8 bits
I2C Trigger	
Trigger Condition	Start, Restart, Stop, Missing Ack, Address, Data, A&D
Address Bits	7 bits, 8 bits, 10 bits
Address Range	0x0 to 0x7F, 0x0 to 0xFF, 0x0 to 0x3FF
Byte Length	1 to 5
SPI Trigger	
Trigger Condition	TimeOut, CS
Timeout Value	16 ns to 10 s
Data Bits	4 bit to 32 bit
Data Line Setting	H, L, X

Measure

Cursor	Manual mode	Voltage deviation between cursors (ΔV) Time deviation between cursors (ΔT) Reciprocal of ΔT (Hz) ($1/\Delta T$)
	Track mode	Voltage and time values of the waveform point
	Auto mode	Allow to display cursors during auto measurement
Auto Measurement	Measurements of Maximum, Minimum, Peak-Peak Value, Top Value, Bottom Value, Amplitude, Average, Mean Square Root, Overshoot, Pre-shoot, Area, Period Area, Frequency, Period, Rise Time, Fall Time, Positive Pulse Width, Negative Pulse Width, Positive Duty Cycle, Negative Duty Cycle, Delay A→B \uparrow , Delay A→B \downarrow , Phase A→B \uparrow , Phase A→B \downarrow	
Number of Measurements	Display 5 measurements at the same time	
Measurement Range	Screen Region	
Measurement Statistic	Average, Max, Min, Standard Deviation, Number of Measurements	
Counter	Hardware 6 bits counter (channels are selectable)	

Math

Waveform Operation	A+B, A-B, A×B, A/B, FFT, &&, , ^, !, intg, diff, sqrt, lg, ln, exp, abs
FFT Window	Rectangle, Hanning, Blackman, Hamming, Flat Top, Triangle
FFT Display	Half, Full
FFT Vertical Scale	dB/dBm, Vrms
Number of Buses for Decoding	2
Decoding Type	Parallel (standard), RS232/UART (option), I2C (option), SPI (option)

Display

Display Type	7.0 inches TFT LCD display
Display Resolution	800 horizontal×RGB×480 vertical pixel
Display Color	160,000 Color (TBD)
Persistence Time	Min, 100 ms, 200 ms, 500 ms, 1 s, 2 s, 5 s, 10 s, 20 s, Infinite
Display Type	Dots, Vectors

I/O

Standard Ports	USB HOST, USB DEVICE, LAN, Aux (TrigOut /PassFail)
----------------	--

Signal Source (DS1000Z-S)

Number of Channels	2
Sample Rate	200 MSa/s
Vertical Resolution	14 bits
Highest Frequency	25 MHz
Standard Waveform	Sine, Square, Pulse, Triangle, Noise, DC

Arbitrary Waveform	Since, Exp.Rise, EXP.Fall, ECG, Gauss, Lorentz, Haversine	
Sine	Frequency Range	0.1 Hz to 25 MHz
	Flatness	±0.5 dB (relative to 1 kHz)
	Harmonic Distortion	-40 dBc
	Stray (Non-Harmonic)	-40 dBc
	Total Harmonic Distortion	1%
	Signal-to-Noise ration	40 dB
Square/Pulse	Frequency Range	0.1 Hz to 15 MHz
	Rise/Fall time	<15 ns
	Overshoot	<5%
	Duty Cycle	10% to 90%
	Duty Cycle Resolution	1% to 10 ns (select the greater one)
	Minimum Pulse Width	20 ns
	Pulse Width Resolution	10 ns or 5 bits (select the greater one)
	Jitter	500 ps
Triangle	Frequency Range	0.1 Hz to 100 kHz
	Linearity	1%
	Symmetry	0 to 100%
Noise ^[1]	Bandwidth	25 MHz
Internal Generated waveforms	Frequency Range	0.1 Hz to 1 MHz
Arbitrary Waveforms	Frequency Range	0.1 Hz to 10 MHz
	Waveform Length	2 to 16k pts
Frequency	Accuracy	100 ppm (lower than 10 kHz) 50 ppm (greater than 10 kHz)
	Resolution	0.1 Hz or 4 bit, select the greater one
Amplitude	Output Range	20 mVpp to 5 Vpp, High-resistance 10 mVpp to 2.5 Vpp, 50 Ω

DC Offset	Resolution	100 μ V or 3 bit, select the greater one
	Accuracy	2% (1 kHz)
	Range	± 2.5 V, High-resistance ± 1.25 V, 50 Ω
	Resolution	100 μ V or 3 bit, select the greater one
	Accuracy	2% (1 kHz)

General Specifications

Probe Compensation Output	
Output Voltage ^[1]	About 3 V, peak-peak
Frequency ^[1]	1 kHz
Power	
Power Voltage	100-240 V, 45-440 Hz
Power	Maximum 50 W
Fuse	2 A, T degree, 250 V
Environment	
Temperature	In operation: 0 $^{\circ}$ C to +50 $^{\circ}$ C
Range	Out of operation: -40 $^{\circ}$ C to +70 $^{\circ}$ C
Cooling Method	Fan
Humidity Range	0 $^{\circ}$ C to +30 $^{\circ}$ C: $\leq 95\%$ relative humidity +35 $^{\circ}$ C to +40 $^{\circ}$ C: $\leq 75\%$ relative humidity +40 $^{\circ}$ C to +50 $^{\circ}$ C: $\leq 45\%$ relative humidity
Altitude	In operation: under 3,000 meters Out of operation: under 15,000 meters
Mechanical	
Dimensions ^[4]	Width \times Height \times Depth = 313.1 mm \times 160.8 mm \times 122.4 mm
Weight ^[4]	Without package 3.2 kg \pm 0.2 kg With package 3.8 kg \pm 0.5 kg
Adjustment Interval	
The recommended calibration interval is one year.	
Regulation Standards	
Electromagnetic	2004/108/EC

Compatibility	Execution standard EN 61326-1:2006 EN 61326-2-1:2006
Safety	UL 61010-1:2004; CAN/CSA-C22.2 NO. 61010-1-2004; EN 61010-1:2001; IEC 61010-1:2001

Note^[1]: Typical.

Note^[2]: Maximum value with 50 ns, single-channel, dots display and auto memory depth.

Note^[3]: Tilt tabs and handle folded, knob height included.

Note^[4]: Standard configuration.

Chapter 18 Appendix

Appendix A: Accessories and Options

	Descriptions	Order Number
Models	DS1104Z (100 MHz, 4-channel)	DS1104Z
	DS1104Z-S (100 MHz, 4-channel+dual-channel, 25MHz signal source)	DS1104Z-S
	DS1074Z(70 MHz, 4-channel)	DS1074Z
	DS1074Z-S(70 MHz, 4-channel+dual-channel, 25MHz signal source)	DS1074Z-S
Standard Accessories	Power Cord conforming to the standard of the country	-
	USB data cable	CB-USBA-USBB-FF-150
	4 passive probes (150 MHz)	RP2200
	Quick Guide	-
	Resource CD (include User's Guide and application software)	-
Optional Accessories	Rack Mount Kit	RM-DS1000Z
Memory Depth Options	24Mpts (single-channel) /12Mpts (dual-channel)/6 Mpts (four-channel)	MEM-DS1000Z
Waveform Record Option	The option supports waveform record and waveform playback	REC-DS1000Z
Advanced Trigger Options	The option include RS232/UART trigger, I2C trigger, SPI trigger, Runt trigger, Window trigger, Nth edge trigger, Delay trigger, Timeout trigger	AT-DS1000Z
Serial Decoding Options	The option include RS232/UART, I2C, SPI decoding function	SA-DS1000Z

Note: all the options or accessories can be ordered from you local **RIGOL** Office.

Appendix B: Warranty

RIGOL warrants that its products mainframe and accessories will be free from defects in materials and workmanship within the warranty period.

If a product is proven to be defective within the respective period, **RIGOL** guarantees the free replacement or repair of products which are approved defective. To get repair service, please contact with your nearest **RIGOL** sales and service office.

RIGOL does not provide any other warranty items except the one being provided by this summary and the warranty statement. The warranty items include but not being subjected to the hint guarantee items related to tradable characteristic and any particular purpose. **RIGOL** will not take any responsibility in cases regarding to indirect, particular and ensuing damage.

Appendix C: Any Question or Comment?

If you have any question or comment on our document, please mail to:
service@rigol.com

Index

- Duty	20	High Resolution	4
- Width	20	I2C Decoding	11
+ Duty	20	IP Address	3
+ Width	20	MAC	5
Acquisition Mode	2	Manual Mode	30
Addition	2	Memory Depth	7
Auto IP	3	Multiplication	3
Auto Mode	35	Network Status	2
Average	2	Normal	2
Bandwidth Limit	3	Nth Edge Trigger	32
Blackman	8	Overshoot	22
Channel Coupling	3	Parallel Decoding	2
Channel Label	7	Pattern Setting	17, 19
CSV	3	Pattern Trigger	17
Cursor	29	Peak Detect	4
Delay	21	Period	20
Delay Trigger	30	Persistence Time	3
Delayed Sweep	2	Picture	3
DHCP	3	Preshoot	23
Division	4	Pulse Condition	10
Domain Name Server	4	Pulse Trigger	10
Dots	2	Pulse Width Setting	10
Duration Trigger	19	Rectangle	7
Edge Trigger	9	Rise Time	20
Edge Type	9	Roll	8
Factory	14	RS232 Decoding	5
Fall Time	20	Runt Trigger	25
FFT	6	Sample Rate	5
Flattop	8	Setup/Hold Trigger	21
Frequency	20	Setups	3
Frequency Counter	24	Sinc	20, 7
Gate	4	Slope Condition	12
Hamming	7	Slope Trigger	12
Hanning	7	SPI Decoding	15

Static IP	3	Vertical Expansion	6
Subnet Mask	4	Vertical Scale	5
Substraction.....	3	Vertical Window	13
Sync.....	15	Video Polarity	15
Threshold	25	Video Standard	15
Time Setting	12	Video Trigger	15
TimeOut Trigger	23	VISA	5
Traces	3	Vmax	22
Track Mode	33	Vmin.....	22
Triangle	8	Vpp	22
Trigger Coupling	5	Vrms.....	22
Trigger Holdoff	6	Vtop	22
Trigger Level	9	Waveform Confusion	5
Trigger Mode.....	3	Waveform Distortion.....	5
Trigger Source.....	2	Waveform Invert	5
USB.....	6	Waveform Leakage.....	6
Vamp	22	Waveforms	3
Vavg.....	22	Window Function	7
Vbase.....	22	X-Y	5
Vectors	2	Y-T	4