

PC910X

Ultra-high Speed Response OPIC Photocoupler

■ Features

1. Ultra-high speed response
(t_{PHL} , t_{PLH} : TYP. 50ns at $R_L = 350\Omega$)
2. Isolation voltage between input and output
(V_{iso} : 2 500V_{rms})
3. Low input current drive (I_{FHL} : MAX. 5mA)
4. Instantaneous common mode rejection voltage (CM_H : TYP. 500V/ μ s)
5. TTL and LSTTL compatible output
6. Recognized by UL, file No. E64380

■ Applications

1. High speed interfaces for computer peripherals and microcomputer systems
2. High speed line receivers
3. Noise-cut
4. Interfaces with various data transmission equipment

■ Outline Dimensions

(Unit : mm)

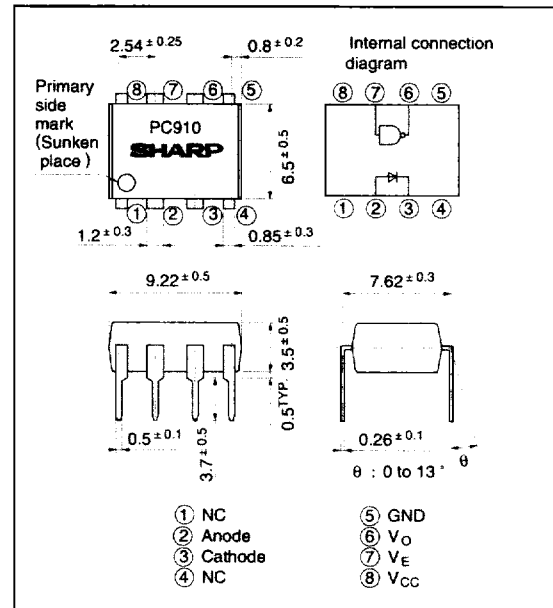

* "OPIC" (Optical IC) is a trademark of the SHARP Corporation.
An OPIC consists of a light-detecting element and signal-processing circuit integrated onto a single chip.

■ Absolute Maximum Ratings

(Ta = 25°C)

Parameter		Symbol	Rating	Unit
Input	*1 Forward current	I_F	20	mA
	Reverse voltage	V_R	5	V
	Power dissipation	P	40	mW
Output	*2 Supply voltage	V_{CC}	7	V
	*3 Enable voltage	V_E	5.5	V
	High level output voltage	V_{OH}	7	V
	Low level output current	I_{OL}	50	mA
	Collector power dissipation	P_C	85	mW
*4 Isolation voltage		V_{iso}	2 500	V _{rms}
Operating temperature		T_{opr}	0 to + 70	°C
Storage temperature		T_{stg}	- 55 to + 125	°C
*5 Soldering temperature		T_{sol}	260	°C

*1 Ta = 0 to 70°C

*2 For 1 minute max.

*3 Shall not exceed 500mV from supply voltage(V_{CC}).

*4 AC for 1minute, 40 to 60% RH. Apply the specified voltage between the whole of the electrode pins on the input side and the whole of the electrode pins on the output side.

*5 For 10 seconds at the position of 2mm or more from lead pins.

■ Electro-optical Characteristics

(Unless otherwise specified, Ta = 0 to 70°C)

Parameter		Symbol	Conditions	MIN.	TYP.	MAX.	Unit		
Input	Forward voltage	V _F	Ta = 25°C, I _F = 10mA	-	1.6	1.9	V		
	Reverse current	I _R	Ta = 25°C, V _R = 5V	-	-	10	μA		
	Terminal capacitance	C _t	Ta = 25°C, V = 0, f = 1MHz	-	60	150	pF		
Output	High level output current	I _{OH}	V _{CC} = V _O = 5.5V, V _E = 2.0V, I _F = 250 μA	-	2	250	μA		
	Low level output voltage	V _{OL}	V _{CC} = 5.5V, V _E = 2.0V, I _F = 5mA, I _{OL} = 13mA	-	0.4	0.6	V		
	High level enable current	I _{EH}	V _{CC} = 5.5V, V _E = 2.0V	-	- 0.8	- 1.8	mA		
	Low level enable current	I _{EL}	V _{CC} = 5.5V, V _E = 0.5V	-	- 1.2	- 2.0	mA		
	High level supply current	I _{CCH}	V _{CC} = 5.5V, I _F = 0, V _E = 0.5V	-	7	15	mA		
	Low level supply current	I _{CCL}	V _{CC} = 5.5V, I _F = 10mA, V _E = 0.5V	-	13	18	mA		
Transfer characteristics	"High→Low" threshold input current	I _{FHL}	V _{CC} = 5V, V _E = 2.0V V _O = 0.8V, R _L = 350Ω	-	2.5	5	mA		
	Isolation resistance	R _{iso}	Ta = 25°C, DC500V, 40 to 60% RH	5 x 10 ¹⁰	10 ¹⁰	-	Ω		
	Floating capacitance	C _f	Ta = 25°C, V = 0, f = 1MHz	-	0.6	5	pF		
	Response time	"High→Low" propagation delay time	t _{PHL}	Ta = 25°C, V _{CC} = 5V R _L = 350Ω, C _L = 15pF I _F = 7.5mA	Fig. 1	-	50	120	ns
		"Low→High" propagation delay time	t _{PLH}			-	50	120	ns
		Rise time, Fall time	t _r , t _f			-	30	60	ns
		"High→Low" enable propagation delay time	t _{EHL}	Ta = 25°C, V _{CC} = 5V R _L = 350Ω, C _L = 15pF I _F = 7.5mA, V _{EH} = 3V V _{EL} = 0.5V	Fig. 2	-	15	50	ns
		"Low→High" enable propagation delay time	t _{ELH}			-	65	100	ns
	CMR	Instantaneous common mode rejection voltage "Output: High level"	CM _H	Ta = 25°C, V _{CC} = 5V, V _{CM} = 10V _(peak) R _L = 350Ω, I _F = 0, V _{O(MIN)} = 2V	Fig. 3	100	500	-	V/μs
		Instantaneous common mode rejection voltage "Output: Low level"	CM _L	Ta = 25°C, V _{CC} = 5V, V _{CM} = 10V _(peak) R _L = 350Ω, I _F = 5mA, V _{O(MAX)} = 0.8V	Fig. 3	- 100	- 500	-	V/μs

All typical values : at Ta = 25°C, V_{CC} = 5V

■ Recommended Operating Conditions

Parameter	Symbol	MIN.	MAX.	Unit
Low level input current	I _{FL}	0	250	μA
High level input current	I _{FH}	7	15	mA
High level enable voltage	V _{EH}	2.0	V _{CC}	V
Low level enable voltage	V _{EL}	0	0.8	V
Supply voltage	V _{CC}	4.5	5.5	V
Fanout (TTL load)	N	-	8	-
Operating temperature	T _{opr}	0	70	°C

- When the enable input is in high level state, external pull-up resistor is unnecessary.
- Connect a by-pass ceramic capacitor (0.01 to 0.1 μF) between V_{CC} and GND at the position within 1cm from pin.

Circuit Block Diagram

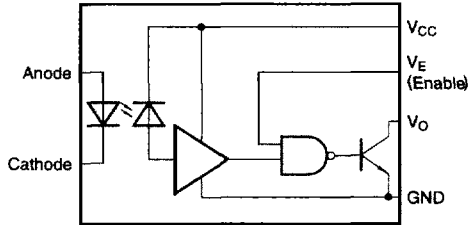

Truth Table

Input	Enable	Output
H	H	L
L	H	H
H	L	H
L	L	H

L : Logic (0)
H : Logic (1)

Fig. 1 Test Circuit for t_{PHL} , t_{PLH} , t_r and t_f

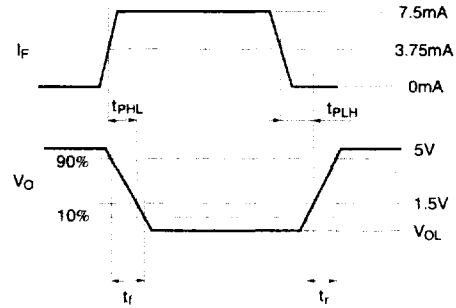
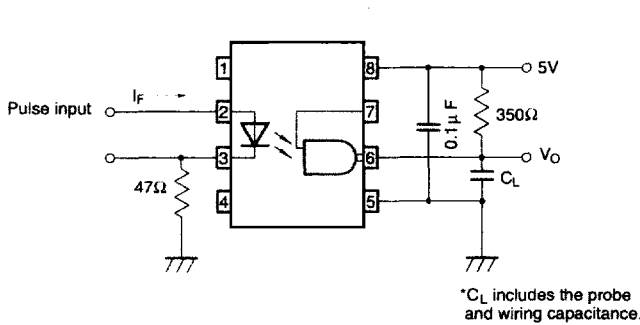

* C_L includes the probe and wiring capacitance.

Fig. 2 Test Circuit for t_{EHL} and t_{ELH}

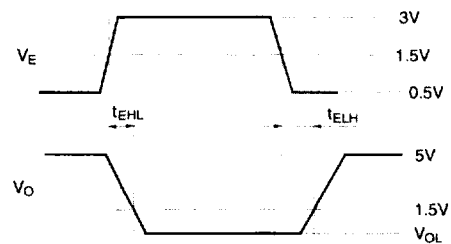
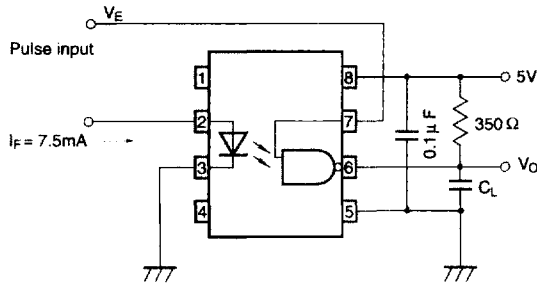
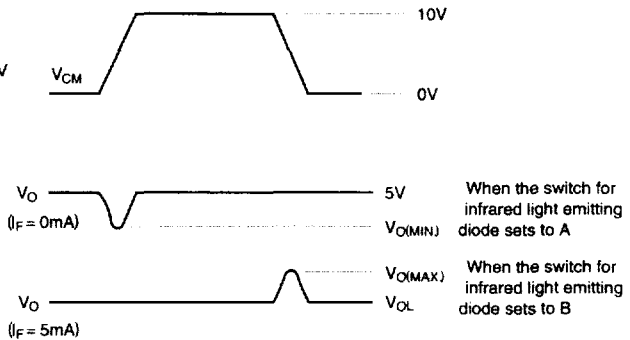
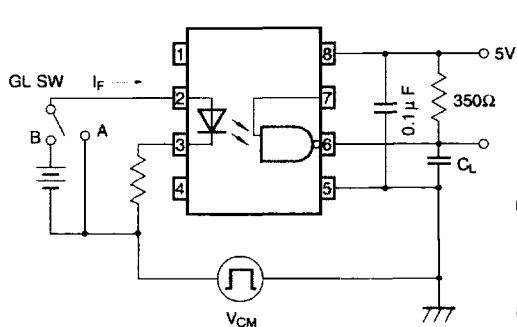

Fig. 3 Test Circuit for CM_H and CM_L



When the switch for infrared light emitting diode sets to A
When the switch for infrared light emitting diode sets to B

Fig. 4 Collector Power Dissipation vs. Ambient Temperature

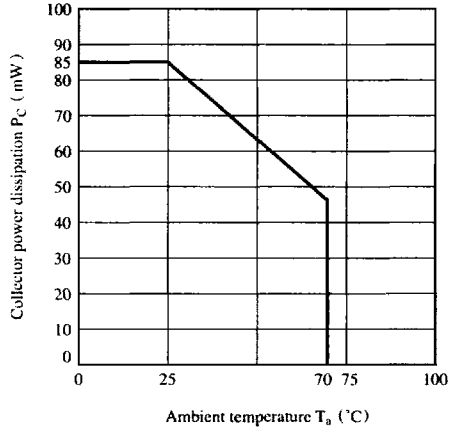

Fig. 5 Forward Current vs. Forward Voltage

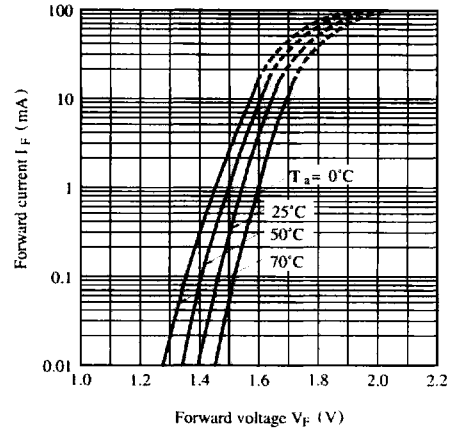

Fig. 6 High Level Output Current vs. Ambient Temperature

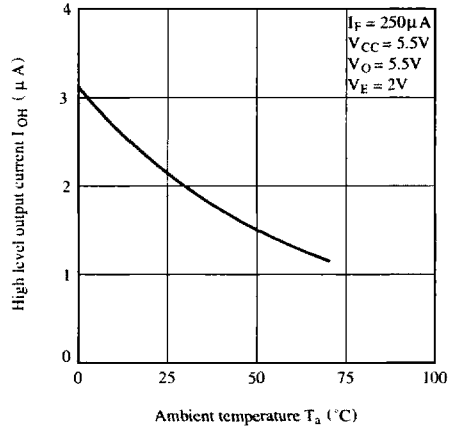

Fig. 7 Low Level Output Voltage vs. Ambient Temperature

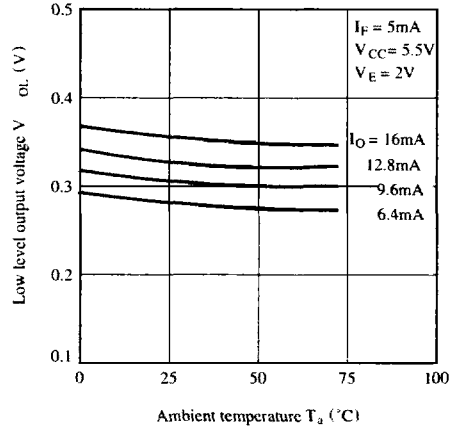

Fig. 8-a Output Voltage vs. Forward Current

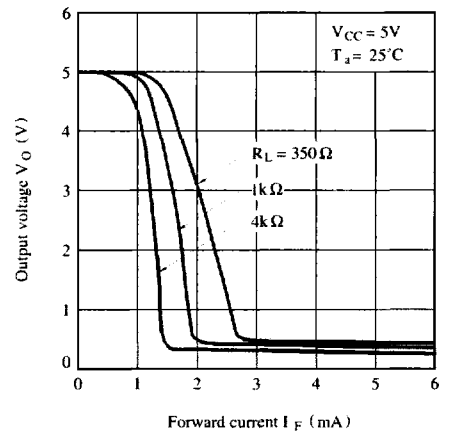

Fig. 8-b Output Voltage vs. Forward Current (Ambient Temp. Characteristics)

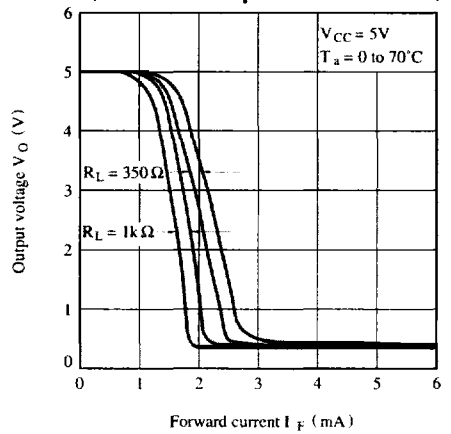

Fig. 9 Propagation Delay Time vs. Forward Current

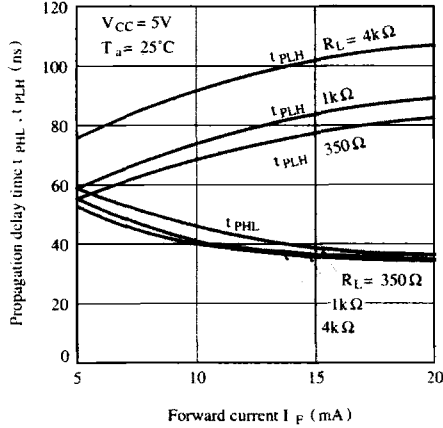

Fig.10 Propagation Delay Time vs. Ambient Temperature

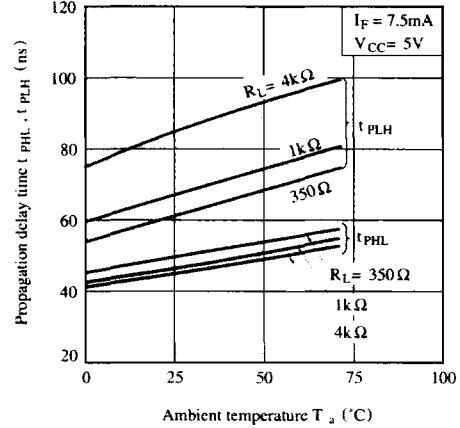

Fig.11 Rise Time, Fall Time vs. Ambient Temperature

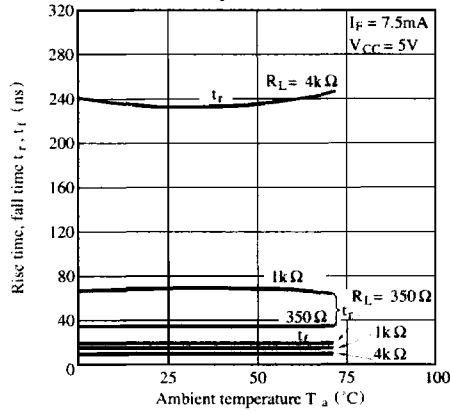
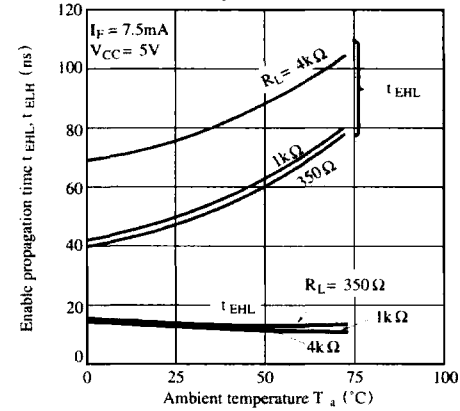

Fig.12 Enable Propagation Time vs. Ambient Temperature



■ Precautions for Use

- (1) Handle this product the same as with other integrated circuits against static electricity.
- (2) As for other general cautions, refer to the chapter "Precautions for Use"