

EMPOWERING OUR WORLD
WITH CLEAN ENERGY



INSTALLATION MANUAL

Balcony Easy Solar Bracket 

V2.0

1. Installation tools

1. Werkzeuge für die Installation



Allen wrench
Inbusschlüssel
(M8-M12)



Tape
Meßband



Twist Wrench
Drehmomentschlüssel
(M8-M12)



Wood Hammer
Holzhammer



Electric Screw Machine
Elektroschrauber



13mm Spanner
Inbusschlüssel

2. System components

2. Komponenten des Systems

(Accessories are subject to the actual product)
(Zubehör unterliegt dem tatsächlichen Produkt)

☑ x 2

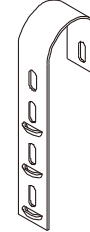

☑ x 2

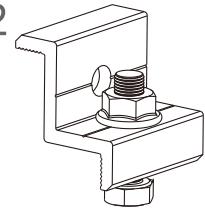

☑ x 2

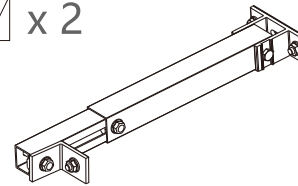

☑ x 2

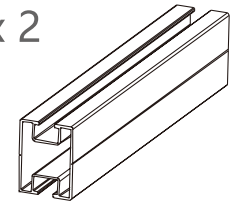

☑ x 2

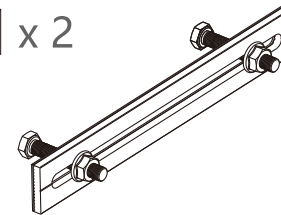

☑ x 2

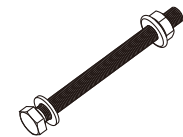



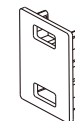



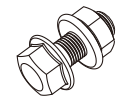





☑ x 4

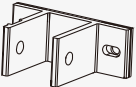
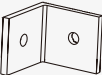

☑ x 3



Product specification
Produktspezifikation

 260mm Al 6005-T5 AlMgSi0.5	 275mm Al 6005-T5 AlMgSi0.5	 300mm Al 6005-T5 AlMgSi0.5	 38mm SUS304 1.4301
 35mm Al 6005-T5 & EPDM	 35mm Al 6005-T5 AlMgSi0.5	 40mm Al 6005-T5 AlMgSi0.5	
 30mm Al 6005-T5 AlMgSi0.5	 220mm Al 6005-T5 AlMgSi0.5	 M8*20 SUS304 1.4301	 M8*25 SUS304 1.4301
 M8*55 SUS304 1.4301	 M8*60 SUS304 1.4301	 M8*90 SUS304 1.4301	

3.Application scenarios

3.Einsatzszenarien

	
Fixed on balcony with 0°	Fixed on balcony with adjustable tilt between 10°-30°;
Schema der Haken-Befestigung auf dem Balkon mit Winkel 0°	Schema der Haken-Befestigung auf dem Balkon mit einstellbarer Neigung zwischen 10°-30°

4.Installation Instruction

4.Installationsanweisung

4.1 Fixed on balcony with adjustable tilt between 10°-30°

4.1 Schema der Haken-Befestigung auf dem Balkon mit einstellbarer Neigung zwischen 10°-30°

4.1.1 Balcony Hook installation: Hooks are attached via bolts and holes in the panel frame

4.1.1 Installation mit Haken auf dem Balkon: Die Haken werden mit Schrauben und Löchern im Plattenrahmen befestigt.

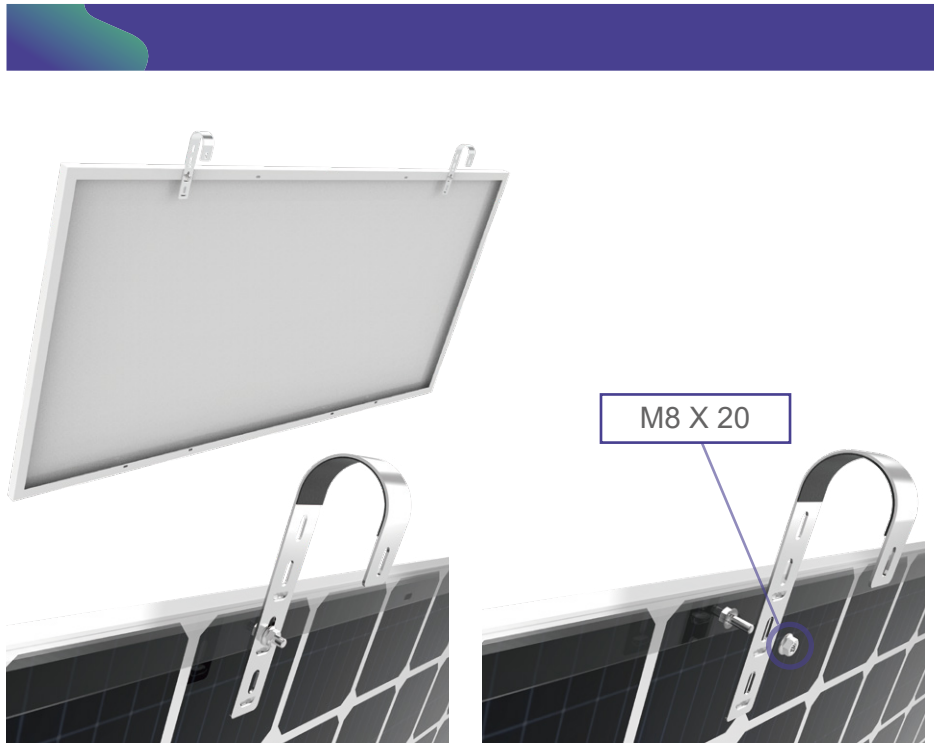

4.12 The hook and railing connection: the hook hangs on the balcony railing, through the bolt to prevent it from falling out;

4.12 Verbindung zwischen Haken und Geländer: Der Haken wird an das Balkongeländer gehängt, und der Bolzen wird hindurchgeführt, damit er nicht herausfallen kann;



4.13 Rail installation: The bolt head snaps into the groove of the rail, the aluminum plate is on the other side of the railing, and the bolt is locked as shown in the picture;

4.13 Installation der Führungsschiene: Setzen Sie den Schraubenkopf in die Nut der Führungsschiene ein, die Aluminiumplatte befindet sich auf der anderen Seite des Geländers, und arretieren Sie die Schraube wie in der Abbildung gezeigt;



M8 X 55



4.14 Installation of telescopic rod: The telescopic rod is pre-installed at the factory, and the base is also locked on the rail with M8 bolts;

4.14 Installation der Teleskopstange: Die Teleskopstange ist werkseitig vormontiert, der Sockel wird ebenfalls mit M8-Schrauben auf der Führungsschiene arretiert;

M8 X 20

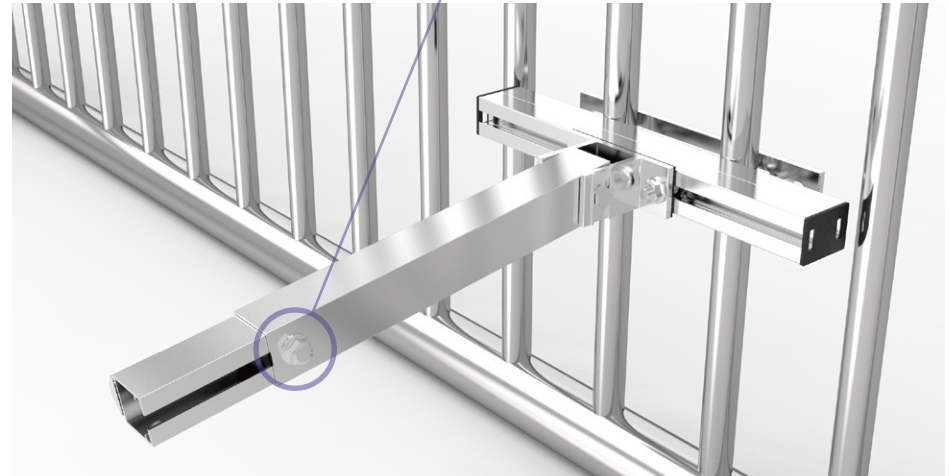

M8 X 60

M8 X 25

End cap | Endkappe



4.15 L foot installation and connection: The L foot is locked on the other side of the panel frame with bolts, and then connected with the telescopic rod with bolts;

4.15 Installation und Verbindung der L-FüÙe: Arretieren Sie den L-Fuß auf der anderen Seite des Paneelrahmens mit Schrauben, und verbinden Sie ihn dann mit der Teleskopstange mit Bolzen;

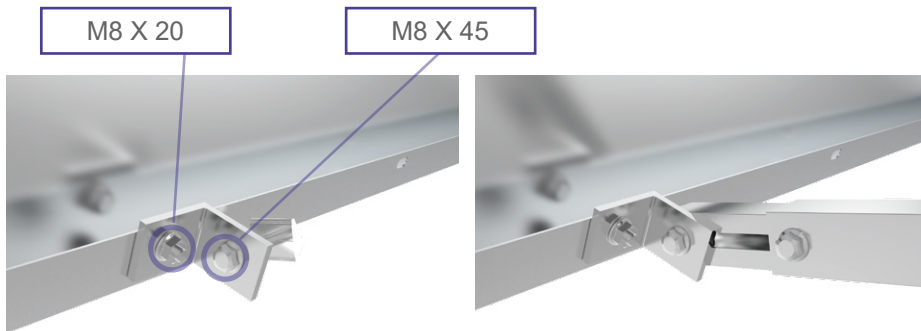

4.16 According to the required angle, adjust the position of the telescopic rod and then lock the bolt, and the installation is completed;

4.16 Passen Sie die Position der Teleskopstange an den gewünschten Winkel an, ziehen Sie die Schraube fest und schließen Sie die Installation ab;



4.2 Balcony hook without angle solution

4.2 Schema der Haken-Befestigung auf dem Balkon mit Winkel 0°

4.21 The hooks and rails are attached to the railing in the same way as the angled ones, removing the adjustable feet and L connectors. Press the panel directly on the guide rail with end clamps, as shown in the picture below. The M8 bolt head is snapped into the slot, and the nut is locked.

4.21 Der Verbindungsmodus zwischen dem Haken, der Führungsschiene und dem Geländer ist derselbe wie mit dem Winkel. Entfernen Sie den verstellbaren Fuß und das L-Verbindungsstück und drücken Sie das Panel direkt mit seitlichem Druck auf die Führungsschiene, wie in der folgenden Abbildung gezeigt; klemmen Sie den Kopf der Schraube M8 in den Schlitz und sichern Sie die Mutter;

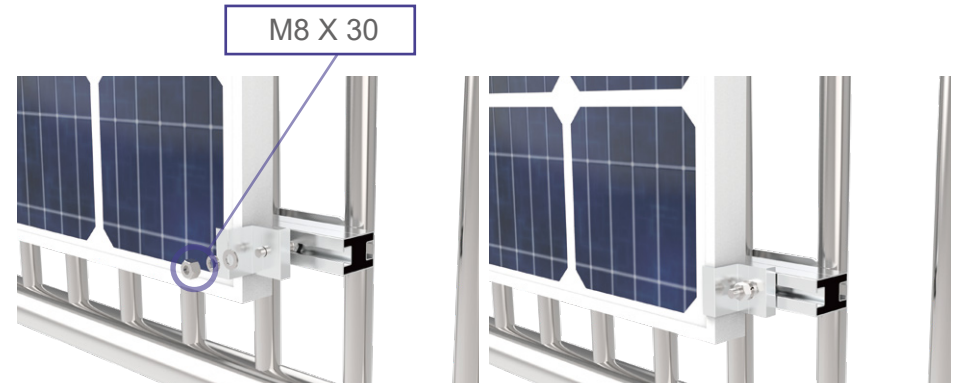

4.22 The installation is completed

4.22 Die Installation ist abgeschlossen

