



Where Luxury Is Affordable

www.the-mspa.com



M Spa® Owner's Manual

P-MB04/06
P-SH06
P-CA04

Mont Blanc
Soho
Camaro

P-CA06
P-EX04/06

Super Camaro
Exotic

EN

DO NOT RETURN MERCHANDISE TO YOUR DEALER STORE DIRECTLY. CALL MSPA AFTER SALES SERVICE CENTER FOR PRODUCT QUESTIONS OR CONTACT MSPA AT

info@the-mspa.com

Due to MSpa continuous product improvement, MSpa reserves the right to change specifications and product appearance, which may result in updates to the instruction manual without notice.



ENTER THE WORLD OF MSPA

Welcome,

Thank you for choosing MSPa and for your confidence in our brand. We believe that you will enjoy many benefits of using MSPa products for years to come.

To guide you in your initial MSPa experience, we are pleased to present you with this instruction manual. Please carefully and thoroughly read this manual entirety before using the product for the first time.

We are delighted to welcome you to the MSPa family, and look forward to sharing with you the full spectrum of our expertise.

Enjoy your MSPa!



Scan the QR code to enter the MSPa official website

CONTENT

Safety precautions.....	3
Specifications and product overview.....	8
First use and set-up preparation.....	10
Spa set-up.....	12
Control panel operation.....	16
Water maintenance and chemicals.....	18
Drainage, cleaning and storage.....	20
Disposal and environmental protection.....	21
Troubleshooting.....	22
MSPa limited warranty policy	24

SAFETY PRECAUTIONS

For your own safety and that of your product, make sure to follow the safety precautions below. Fail to follow the instruction may result in serious injury, property damage or death. Improper installation or operation will void the warranty.

READ, UNDERSTAND AND FOLLOW ALL INSTRUCTIONS

DANGER

- Risk of Accidental Drowning. Extreme caution must be exercised to prevent unauthorized access by children.
- Risk of drowning. Inspect the spa cover regularly for leak, premature wear and tear, damage or signs of deterioration. Never use a worn or damaged cover: it will not provide the level of protection required to prevent unsupervised access to the spa by a child.
- Risk of drowning. Always lock the spa cover after each use.
- Risk of injury. If the supply cord is damaged, it must be replaced by the manufacturer, its service agent or similarly qualified persons in order to avoid a hazard.
- Risk of Electric Shock. Do not permit any electrical appliances, such as a light, telephone, radio or television within 1.5m (5 feet) of a spa tub.
- Risk of Electric Shock. Do not use the spa when it is raining, thundering or lightning.

WARNING

- To reduce the risk of electric shock, do not use an extension cord, timers, plug adaptors or converter plugs to connect the unit to electric supply; provide a properly located outlet.
- The spa must be connected to a grounded mains supply with a supply cord fitted with a plug and PRCD with a tripping current of 10mA.
- Parts containing live parts, except parts supplied with safety extra-low voltage not exceeding 12V, must be inaccessible to occupants in the spa.
- Parts incorporating electrical components, except remote control devices, must be located or fixed so that they cannot fall into the spa.

- Residential electrical connection box must be located safely with a distance of at least 2m away from the spa.
- Electric installation should fulfill the local requirement or standards.
- Do not press down or uplift the control panel or put any heavy items on the control panel after installations.
- This appliance can be used by children aged from 8 years and above and persons with reduced physical, sensory or mental capabilities or lack of experience and knowledge if they have been given supervision or instruction concerning use of the appliance in a safe way and understand the hazards involved. Children shall not play with the appliance. Cleaning and user maintenance shall not be made by children without supervision.
- To reduce the risk or injury, do not permit children use this product unless they are closely supervised all times.
- To reduce the risk of child drowning, supervise children all times. Attach and lock spa cover after each use.
- Make sure the floor is capable of supporting the expected load, which you can find from the spec sheet, calculate the expected load of water capacity plus total weight.
- Adequate draining system must be provided around the spa to deal with overflow water.
- To reduce the risk of injury:
 - a) Lower water temperatures are recommended for young children and when spa use exceeds 10 minutes. In order to avoid the possibility of hyperthermia (heat stress) occurring it is recommended that the average temperature of spa-pool water should not exceed 40°C(104°F).
 - b) Since excessive water temperatures have a high potential for causing fetal damage during the early months of pregnancy, pregnant or possibly pregnant women should limit spa water temperatures to 38°C(100°F).
 - c) Before entering a spa or hot tub the user should measure the water temperature with an accurate thermometer since the tolerance of water temperature regulating devices varies.
 - d) The use of alcohol, drugs or medication before or during spa use may lead to unconsciousness with the possibility of drowning.
 - e) The use of alcohol, drugs, or medication can greatly increase the risk of fatal hyperthermia in spas.
 - f) The causes and symptoms of hyperthermia may be described as follows:
Hyperthermia occurs when the internal temperature of body reaches a level

several degrees above the normal body temperature 37°C(98.6°F). The symptoms of hyperthermia include an increase in the internal temperature of body, dizziness, lethargy, drowsiness, and fainting. The effect of hyperemia include failure to perceive heat; failure to recognize the need to exit spa; unawareness of impending hazard; fetal damage in pregnant women; physical inability to exit the spa; and unconsciousness resulting in the danger of drowning.

- g) Obese persons or persons with a history of heart disease, low or high blood pressure, circulatory system problem, or diabetes should consult a physician before using a spa.
 - h) Persons using medication should consult a physician before using a spa since some medication may induce drowsiness while other medication may affect heart rate, blood pressure, and circulation.
 - i) Check with doctor before use if pregnant, diabetic, in poor health, or under medical care.
- People with infectious disease should not use a spa or hot tub.
 - To avoid injury exercise care when entering or existing the spa or hot tub.
 - Water temperature in excess of 42°C(108°F) may be injurious to your health.
 - Never use a spa or hot tub alone or allow others to use the spa alone.
 - Do not use a spa or hot tub immediately following strenuous exercise.
 - Spa heat in conjunction with alcohol, drugs, or medication can cause unconsciousness.
 - Exit immediately if uncomfortable, dizzy, or sleepy. Spa heat can cause hyperthermia and unconsciousness.

Do not put the spa under 0°C(32°F) environment in order to avoid freezing if there is still water in the pool.

It's helpful to put temp barrier mat in between the spa pool and the ground. Similar mat which is made of foam material or other materials with heat barrier function can also be used. Do not turn on the spa when the water is frozen.

- Never pour water with a temperature higher than 40°C(104°F) into the spa directly.
- Always unplug this product from the electrical outlet before removing, cleaning, servicing or making any adjustment to the product.
- Never jump or dive into a spa or any shallow body of water.
- No part of the electric appliance is to be located above the bath during use.
- Do not bury the electrical cord. Locate the cord where it will not be damaged by lawn mowers, hedge trimmers and other equipment.

- Do not attempt to plug in or unplug this product while standing in water or when your hands are wet.
- Do not use the spa if damaged in delivery and/or malfunctioning in any way.
- Contact the MSpa service center for further direction.
- Keep all pets away from the spa to avoid any damage.
- Do not add bath oil or bath salt to the spa water.

CAUTION

- Always add chemicals to water, never add water to chemicals. Adding water to chemicals may cause strong fumes or violent reactions and hazardous chemical spray.
- For water already used, discharge it in time or use water chemicals for cleaning. Usually, change water every 3-5 days.
- Use Mspa chemical kit for disinfection in accordance with manufacture's instructions.
- Do not leave or set up the spa in temperature lower than 4°C(39°F) if heater is not operating.
- Always enter and exit the spa or hot tub slowly and cautiously. Caution of wet floor.
- To avoid damage to the pump, never turn on the spa or hot tubs unless it is filled with water to the minimum water line.
- Place the spa or hot tub only on a properly prepared site that can withstand the floor loading requirement of the spa.
- Do not leave the spa empty for extended period of time. Drain away water inside the pool thoroughly for long time disuse. Do not expose the spa under direct sunshine. Check regularly before each use. Put away the spa or fence it up in time after using.
- Open the spa top lid when the Bubble function is on.
- In order to avoid a hazard due to inadvertent resetting of the thermal cut-out, this appliance must not be supplied through an external switching device, such as a timer, or connected to a circuit that is regularly switched on and off by the utility.
- Refer to relevant chapter for details concerning cleaning and other maintenance.



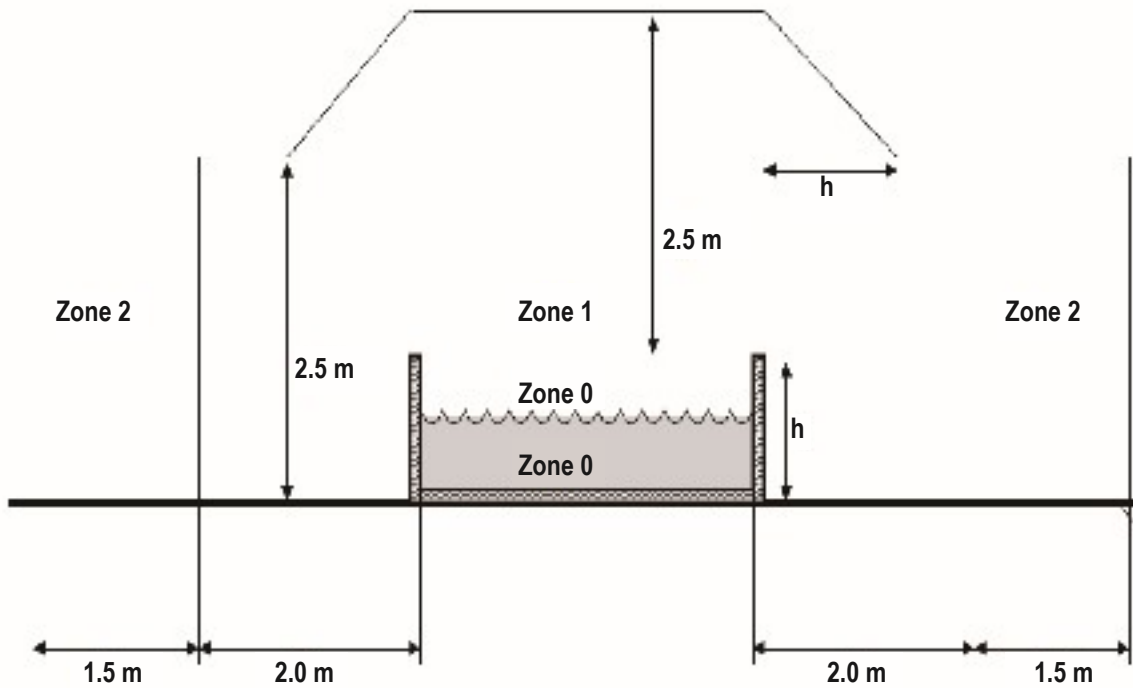





Warning: Water protection levels of appliance at different product zones are different see the following scheme. (**Installation regulations comply to IEC 60364-7-702**)



NOTE-The measured zone dimensions are limited by walls and fixed partitions.

Zones	Description of the zones
Zone 0	Zone 0 is the interior of the basin including any recesses in their walls or floors.
Zone 1	Zone 1 is limited by <ul style="list-style-type: none"> • Zone 0 • A vertical plane 2m from the rim of the basin. • The floor or the surface expected th be occupied by persons • The horizontal plane 2.5m above the floor or the surface
Zone 2	Zone 2 is limited by <ul style="list-style-type: none"> • A vertical plane external th zone 1 and parallel plane 1.5m from the former. • By the floor or surface intended to be occupied by persons.





SPECIFICATIONS

BUBBLE SPA							
Model No. / Code	Shape	Seating Capacity	Water Capacity	Outside Dimensions	Inside Dimensions	Height	Weight
P-MB04 / MONT BLANC	Round	4 	700Ltr (184gal)	1.80m (71")	1.40m (55")	0.70m (28")	28kg (61.7lbs)
P-MB06 / MONT BLANC	Round	6 	930Ltr (245gal)	2.04m (80")	1.60m (63")	0.70m (28")	33kg (72.8lbs)
P-SH06 / SOHO	Square	4  + 2 	930Ltr (245gal)	1.85m (73")	1.45m (57")	0.68m (27")	35kg (77.2lbs)
P-CA04 / CAMARO	Round	4 	700Ltr (184gal)	1.80m (71")	1.40m (55")	0.70m (28")	31.5kg (69.4lbs)
P-CA06 / SUPER CAMARO	Round	6 	930Ltr (245gal)	2.04m (80")	1.60m (63")	0.70m (28")	34.5kg (76.1lbs)
P-EX04 / EXOTIC	Round	4 	700Ltr (184gal)	1.80m (71")	1.40m (55")	0.70m (28")	34.5kg (76.1lbs)
P-EX06 / EXOTIC	Round	6 	930Ltr (245gal)	2.04m (80")	1.60m (63")	0.70m (28")	37kg (81.6lbs)

Control System Specs	P-MB04 / MB06 / SH06 / CA04 / CA06 / EX04 / EX06
Control System	220-240V/50Hz
Total Power	2300W
Heater	1500W
Massage Air Blower	3 Levels (Level 1: 300W, Level 2: 500W, Level 3: 720W)
Filter Pump	12V/60W
Integrated Ozone Generator	5.5W, 30-50mg/Hr
Top Lid	Premium PVC leather cover with foil inside
Pool Cover	Premium PVC tough leather, waterproof and anti-UV
Pool Material	Premium PVC fabric

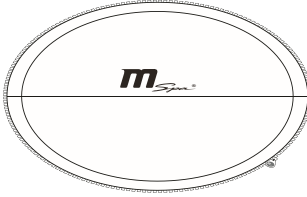
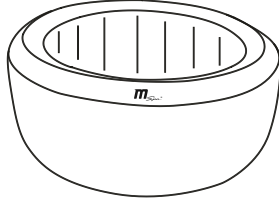
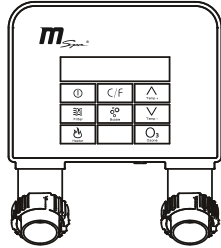
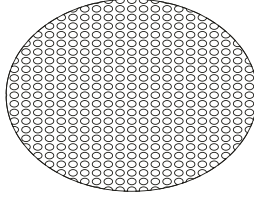
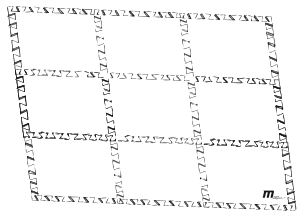
PRODUCT OVERVIEW

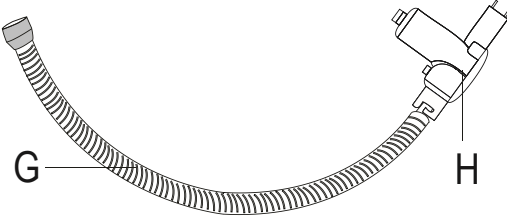
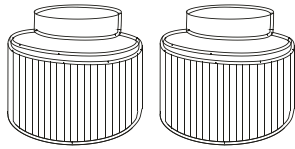
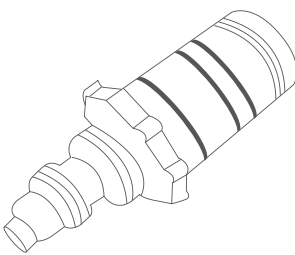
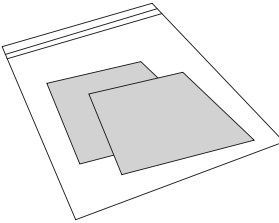
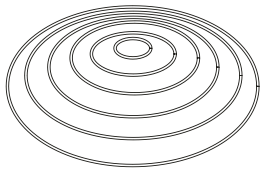
Packaging content

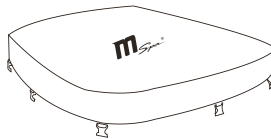
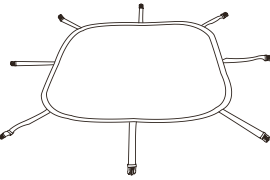
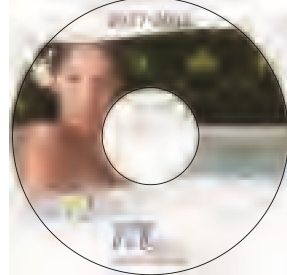
<p>A.</p> 	<p>B.</p> 	<p>C.</p> 	<p>D.</p> 
<p>E.</p> 	<p>F.</p> 	<p>G.</p>  <p>G</p> <p>H</p>	
<p>I.</p> 	<p>J.</p> 	<p>K.</p> 	<p>L.</p>  <p>* Round or square</p>
<p>M.</p> 	<p>N.</p>  <p>* Buckle spa cover</p>	 <p>* Ground mat</p>	<p>O.</p> 

NOTE: Drawings for illustration purpose only. Actual product may vary. Not to scale.

REF. NO.	PARTS DESCRIPTION	QTY.
A	Spa cover with aluminum foil inside (Soho P-SH06 comes with a ground mat with the cover)	1
B	Spa tub	1
C	Control panel	1
D	Heat preservation bubble mat (For P-MB04/06 / P-CA04/06)	1
E	Heat preservation foam mat (For P-EX04/06)	1
F	Digital lock (except for Soho P-SH06)	1
G	Inflation hose	1
H	Manometer	1
I	Filter cartridge set (twin pack)	1
J	Spa drain valve adaptor	1
K	Repair kit	1
L	Spa cover inflatable bladder	1
M	Wrench	1
N	Buckle spa cover and ground mat set	1
O	Instruction DVD	1

NOTE: When ordering parts, be sure to quote the model number and part numbers.

FIRST USE AND SET-UP PREPARATION

Site preparation and requirements

- The spa can be installed indoor and outdoor. For household use only.
- The spa must be set up on a flat, smooth and supporting surface that is capable of supporting the maximum load of the filled spa with listed maximum occupants.
- Make sure the area is free of sharp objects under or around the spa. Uneven or unsound surfaces can damage the spa and void your warranty. Level the surface before filling spa with water.
- Provide adequate drainage system around the spa to deal with overflow water and splashes.
- Make sure there is enough clearance around the spa for full access to the spa equipment for maintenance and/or service.

Additional requirements for indoor installation

- Verify the supporting floor can support the filled weight of spa with maximum number of occupants. Check with a qualified contractor or structural engineer to verify the requirement.
- Make sure the floor is water resistant and provides non-slip surface. Do not install the spa on a carpet of any other material that could be damaged by the moisture.
- Humidity is a naturally side effect of indoor spa installation. The room shall be properly ventilated to allow moisture to escape. Install a ventilating system to prevent excess condensation moisture in the room.

Additional requirements for outdoor installation

- Make sure to set up the spa on a firm, level and smooth surface that is strong enough to support the full weight of the filled spa and maximum occupants.
- Do not set up the spa on grass or dirt, as this increases the amount of debris entering the spa, and damage the spa floor.
- Do not leave the spa tub exposed to direct sun light for extend period of time.
- It is the possible to install and leave the spa outside at a temperature not lower than 4°C (39°F) and the water inside the circulation system, pump, pipe are not frozen. Put a Heat Preservation Mat or the Electric Heating Mat (*Optional) in between the spa bottom and the ground to prevent heat loss from the bottom of the spa and to provide better heat retention.

PRCD Testing

⚠ WARNING

Risk of electric shock: This product is provided with a PRCD located at the end of the power cord. The PRCD must tested before each use. Do not use the spa if the PRCD does not function properly. Disconnect the power cord until the fault has been identified and corrected. Contact a licensed electrician to correct the fault. There are no serviceable parts in side the PRCD. Opening the PRCD will void the warranty.

1. Plug the machine into the mains.
2. Press the **RESET** button on the PRCD. The indicator turns red.
3. Press the **TEST** button on the PRCD. The PRCD indicator should shut off. If the PRCD indicator does not turn off, the PRCD is faulty.
4. Do not use the spa. Contact a qualified electrician to correct the fault.
Press the **RESET** button on the PRCD again. The indicator should turn red. If yes, the spa is ready for use.

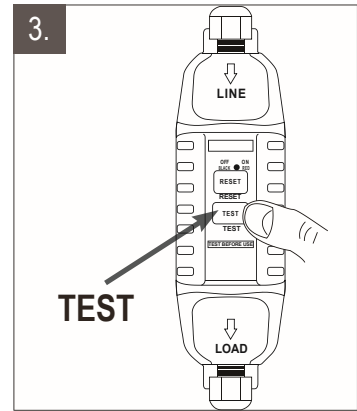
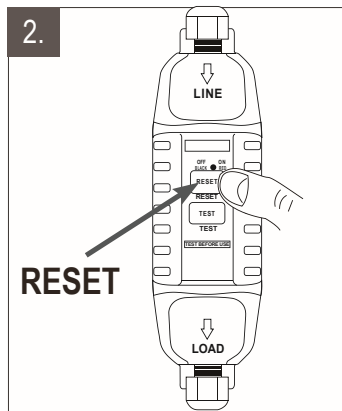
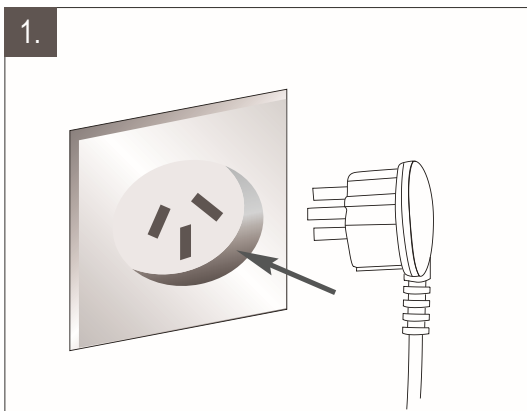

Spa Control Unit Connected External Equipotential Bonding Conductors

A qualified electrician shall wire the spa control unit to the household equipotential terminal using a minimum 1.5mm² solid copper conductor as follow.

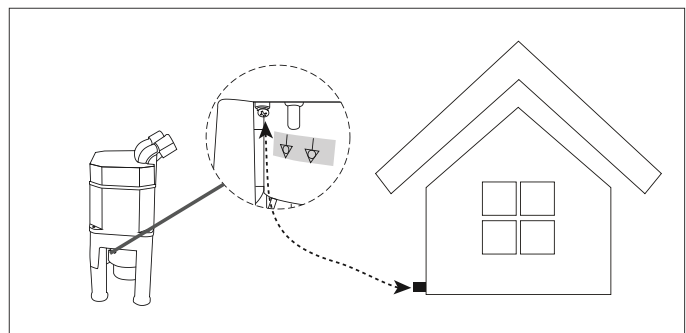

SPA SET-UP

1. Move the entire package to the selected site. Open the carton carefully as it can be used to store the spa during long term storage or when not in use.
2. Lay out all the parts on the ground and make sure all parts are accounted for. Make sure the spa tub is right side up. (*For missing or damaged part, contact the MSpa Service Center)
3. Spread the Heat Preservation Ground Mat over a cleared area. Spread out the spa liner over the ground mat. Heat Preservation Mat prevents heat loss from the bottom of the unit.

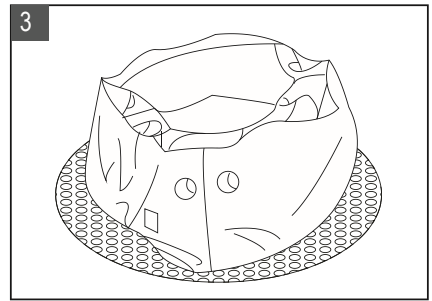
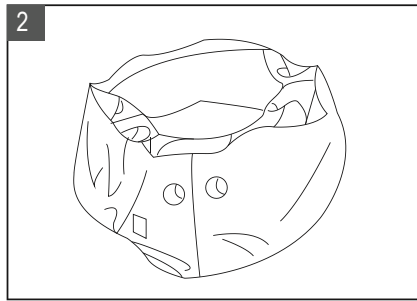
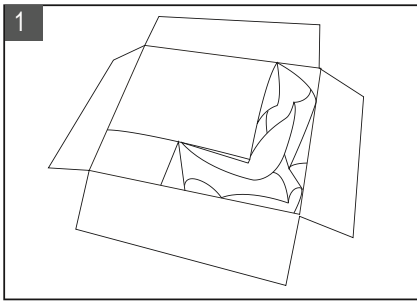

- **NOTE:**
Soho P-SH06: Spread out the square ground mat and place it to the selected site. Make sure the buckle of cover and mat is attached when spa not in use.

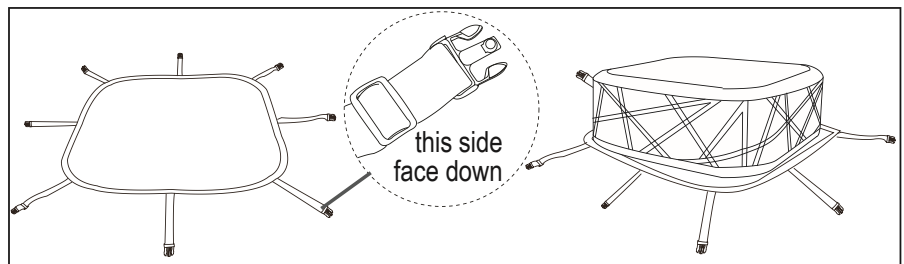

4. **Connect the digital cable.** Find the digital cable, loose the cap on the end, and plug into the cable port on the control panel. Once the cable is connected properly, the backlight of the buttons area will light up on the panel.

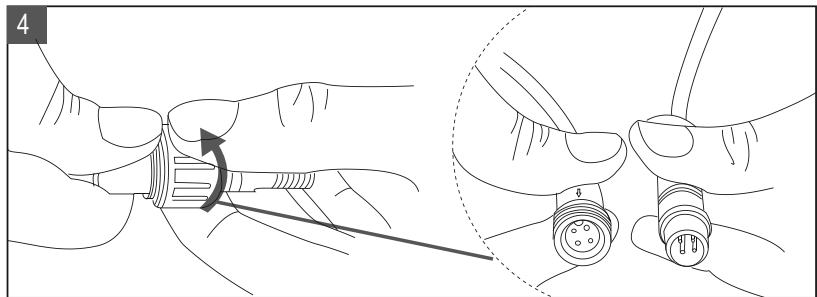

5. Connect the control panel to the spa tub. Fasten and secure the rings to the pipe adapter on the spa tub. (Fig.5) Make sure the rubber O-rings are properly placed on the air pipes.

CAUTION: Lost of the O-rings may result spa and the bubbling function working improperly, and also cause the air pump rusted.

NOTE: For spa models have PVC leather covers, make sure the spa cover is onto the spa tub properly before connecting the control panel. The two holes on the leather cover must be positioned correctly to the pipes of control panel air pipes.

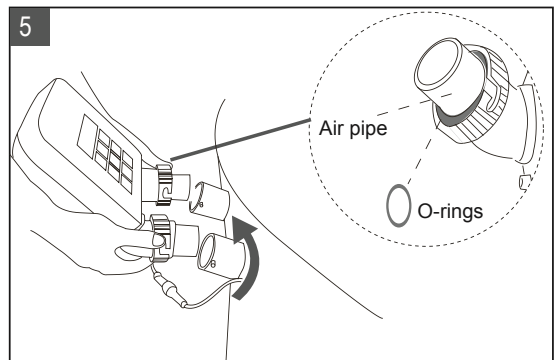

6. Spa Inflation

- 6.1 Unscrew the air valve cap (a) on the control panel to reveal the air blower inflation outlet and connect one end of the inflation hose (b) to the outlet. See Figure 6.1
- 6.2 Unscrew the air valve cap on the spa pool and reveal the stem for inflation.
- 6.3 Connect the other end of the inflation hose (b) to the manometer (c) first and then insert to the air valve.

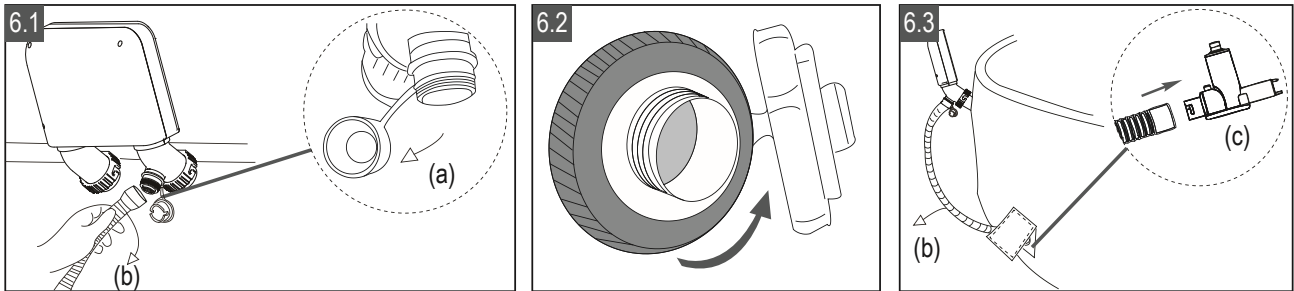

- 6.4 Press the Bubble  button to inflate the spa tub until it is firm to touch.

CAUTION: Do not over inflate. Over inflation may cause spa leakage and void the warranty.

- 6.5 Pay attention to the Manometer. The **Yellow** section appears when the spa is properly inflated. The **Green** section shows when water filling is completed. Repeat previous steps if more air is necessary.

CAUTION: The **Red** section shows when the spa is over inflated. Press the black button (a) on the manometer to release some air until it points the green section.

IMPORTANT: During spa use, the manometer shall only shows the **Green** section at all times.

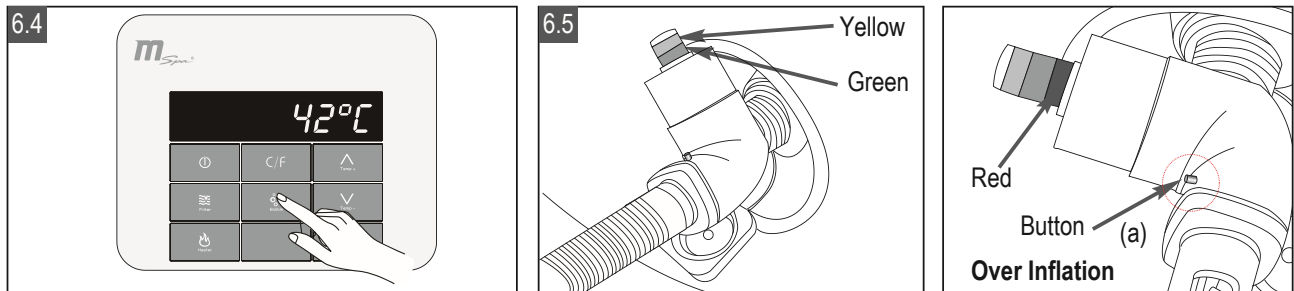



- 6.6 When inflation is completed. Press Bubble  button for more than 3 seconds to turn off the function. Disconnect the inflation hose on both ends. Replace the air valve cap back.

NOTE:

- The cap is designed to be screwed on and off. Never exert force as this could cause the complete internal inflation system of the valve to come loose.
- If over inflated, remove the inflation hose from the spa air valve side, screw the valve cap to release some air and stop until the manometer points to the right color section.

7. Spa Bladder Inflation.

- 7.1 Open the air valve (a) on the bladder. Insert the inflation hose (b) into the valve
- 7.2 Press the Bubble  button to inflate until it is firm to touch but not hard.
- 7.3 Press Bubble  button for more than 3 seconds to turn off the function. Disconnect the inflation hose from the air blower outlet and the valve

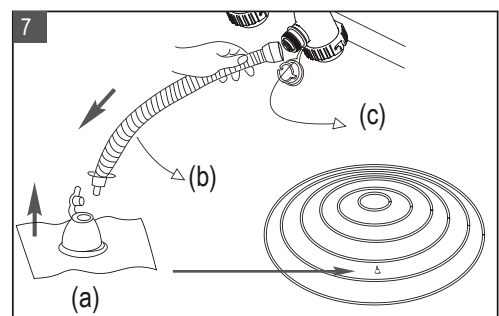

7.4 Replace the air valve cap (c) back on the control panel. Close and recess the inflation valve (a)

NOTE: Deflation Instruction

Spa Deflation

1. Unscrew the air valve cap on the spa pool to deflate the spa.
2. Once the deflation is completed, replace the cap back.

Spa Bladder Deflation

1. Pull the valve cap out and squeeze the valve at its base until deflated.
2. Close and recess the valve back.

8. Water Filling

- 8.1 Check the spa liner is at the selected area and point the drain valve toward a suitable draining area before inflation.
- 8.2 Fill the spa tub with fresh water to a level between **Minimum** and **Maximum** line marked on the inside of the spa wall.

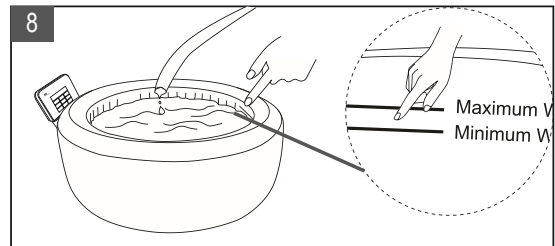

Do not over fill the spa. It is recommended to fill the spa with lukewarm water for quick heating and energy saving.

WARNING:

- **Water level must reach the Minimum water line but not exceed the Maximum line to avoid pump failure.**
- **Never pour water with a temperature higher than 40°C(104°F) into the spa directly.**
- **To avoid control system failure, do not operate the spa until water reaches the Minimum line.**

- 8.3 After water filling, double check the spa pool air pressure to make sure the manometer points out the Green section.
- 8.4 Place the inflated air bladder and the zipper spa cover over the spa tub, and make sure the spa cover zipper are closed and lock the cover by the digital lock in the accessory pack.

IMPORTANT:

- Inspect the spa pressure regularly for leak, premature wear or deterioration.
- Check and wax the zipper regularly, to make it smooth for operation and avoid splits.

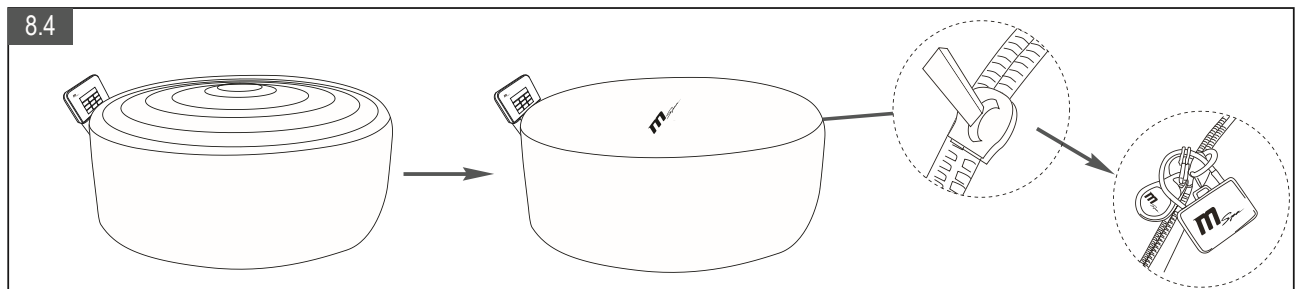

- 8.5 Turn on the Heater on the spa control panel, refer to the “Control Panel Operation” section. Maximum heating temperature is 42°C(108°F). Hourly heating rate is about 1.5°C-2°C(2.5°F-3.5°F) for 4 persons and 1.2°C-1.8°C(2°F-3°F) for 6 persons.

9. Zipper and Buckle Operation

9.1 Digital Lock Operation

Original password is “000”. Following the steps below to change the password:

- Push the button (a) in the direction of Fig. 9.1.(1) to unlock the digital lock.
- Set your preferred password in 3 digits by turning the number wheel (b), see Fig.9.1.(2).
- Insert back the cable (c). The new password is set.

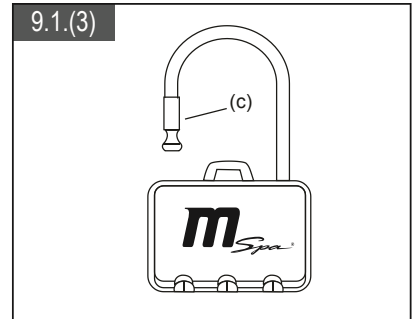
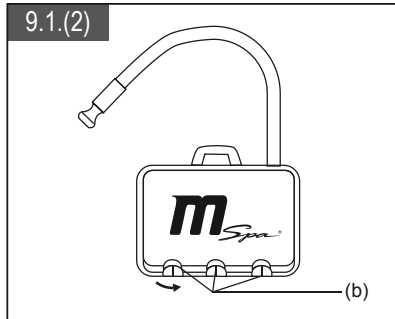
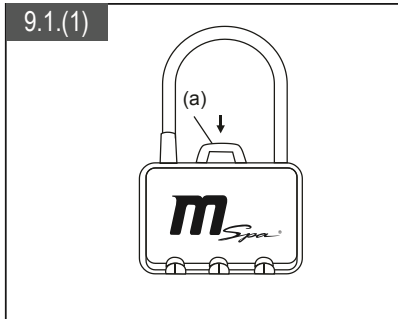

9.2 Square Spa Buckle Lock Operation

Lock the Buckle

- Insert the buckle on the Ground Mat into the Spa cover buckle, until you hear a “Click” sound.

Unlock the Buckle

- Pinch both sides of the locked buckle, and press down the round dot in center in the same time. Press down the center button and release the lock.

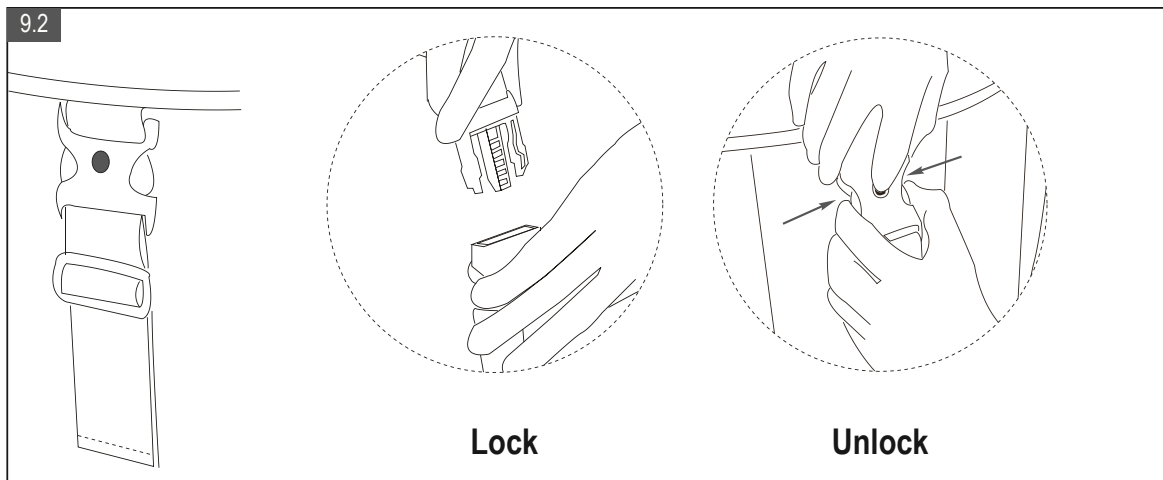

CONTROL PANEL OPERATION

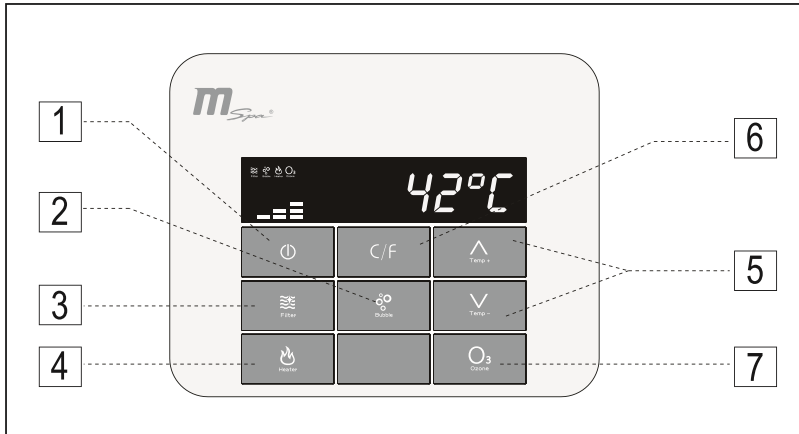

1. ON/OFF Button
2. Bubble Button - *Adjust the bubble level by pressing the button (L1:300W, L2: 500W, L3:720W)*
3. Filter Button
4. Heater Button
5. Temperature UP & DOWN Button
6. Celsius/Fahrenheit Toggle Button
7. Ozonator Button



ON/OFF Button: To activate the control panel.

LCD displays the current temperature and backlight is white when the power is on, all functions can be opened.



Bubble Button: Can adjust among 3 levels of bubbling power. The default bubbling massage power is level 2 (500W) . Press the BUBBLE button again, switching to level 3 (720W) . Press again made to level 1 (300W) . To shut down the function, press the BUBBLE button for 3 seconds.

NOTE: The bubbling massage function will be shut down automatically after every 20 minutes operation for safety concern. It can not be operated within 10 minutes after shut down. The bubbling massage function will be filtered automatically after 4-hour.



Filter Button: Activate the filter pump. The Filter icon shows when the filtration system is activated.

NOTE: Filtration cannot be turned off when heating is activated. When the Heating function is turned off, Filtration will be stopped after 30 seconds. Filtration function can be then activated separately.

NOTE: Auto-filtration system every 4 hours.



Heater Button: Use this button to activate the HEATING and FILTRATION function at the same time. The heater will heat the spa water until the water temperature reaches the pre-set temperature. After the current water temperature drops below the set temperature, the heating system will restart automatically. The Heater icon shows when the heating system is activated. When the Heater icon is flashing, the heating system is at rest and the water is at set temperature.

NOTE: If you want to open the HEATING and FILTRATION functions, just press on the HEATER button.



Temperature Adjustment Buttons: To adjust the current temperature, press the UP or Down button, and the LCD screen flashes to display the set temperature. The temperature interval is one degree. The LCD displays the current temperature if no further operation more than 3 seconds.

NOTE: The default temperature is 38°C(100°F).

NOTE: Temperature adjustment ranges from 20°C(68°F) to 42°C(108°F).



Celsius/Fahrenheit Toggle Button: The temperature can be displayed in either Celsius or Fahrenheit. The system's default is Celsius.

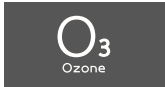

Ozonator Button: Activate the Ozone. The Ozone icon shows when the Ozone function is activated. For bathers' safety concern, the ozonator cannot be operated at the same time when the Bubbling function is on. The Ozonator will be off automatically after operating for 2 hours. Ozone output is 30-50mg/Hr.

NOTE: Please do not soak in the spa when the Ozone is on. The Ozonator will not work when the spa has no water or when the Bubble Button is on.

IMPORTANT : The following conditions will lead to slow water heating

- The ambient temperature is lower than 10°C(50°F)
- Outdoor wind speed is above 3.5-5.4m/s(8-12mph)
- The air bubble function is activated when heater is on
- The spa is not properly covered with the spa cover when heater is on

ERROR CODE CHART

LCD READING	CAUSE	SOLUTION
E0	Water temperature is lower than zero degree or exceed 55°C(131°F)	Change the water or contact the MSpa Service Center.
	Temperature sensor failure	
E1	Water pressure switch failure	Contact the MSpa Service Center.
	Filter failure	
	Water level is not at minimum water line	Add more water to the minimum line.
E2	Detecting function failure	Contact the MSpa Service Center.
	No water in the spa tub	Add more water to the minimum line.
E3	System failure	<p>System self-checking</p> <p>Step 1: Fill water to the water line, and make sure that there is no bather or object in the spa tub.</p> <p>Step 2: Connect the power supply, press RESET button on the PRCD.</p> <p>Step 3: If E3 shows, contact the MSpa Service Center. If E3 is flashing, press ON/OFF, C/F, TEMP + buttons once in sequence, enter to the self-checking system. If no error code shows, failure is not detected. It is OK to use the spa. If error code shows after self-checking, contact the MSpa Service Center.</p>
E4	Heating failure	Contact the MSpa Service Center.

WATER MAINTAINANCE AND CHEMICALS

Water Sanitation

The spa owner must regularly check and keep the spa water sanitized with scheduled maintenance (daily, if necessary). Adding sanitizer or other chemical will control bacteria and viruses present in the spa water. The maintenance of a proper water balance through appropriate use of sanitizers is the most important factor in maximizing the life and appearance of the spa as well as ensuring clean, healthy and safe water.

Proper technique is important for water testing and treating the spa water. See your spa professional for chemical, sanitizer, test kit and testing procedures questions.

CAUTION:

- Always follow the chemical manufacturer's direction, and the health and hazard warning.
- Do not add chemicals if the spa is occupied. This can cause skin or eye irritation.
- Concentrated chlorine solutions can damage the spa tub. Improper chemical use will void the warranty.

Maintenance of Spa Water and Cartridge

Protect all the spa occupants from possible water related illness by keeping the spa water clean and sanitized. Always practice good hygiene. To ensure proper spa water quality by following these procedures:

1. Inspect and clean the filter cartridge after each use, and change the filter cartridge after it works continuously for 72 hours.
 - Unscrew the cartridge assembly from the spa tub wall and remove the cartridge by turning it counter clockwise (Fig. 1.1)
 - Use a garden hose to rinse off the cartridge. If the cartridge remains soiled and discolored it should be replaced. Keep spare cartridges on hand.(Fig.1.2). **There are two filter cartridges from the original package, one is for use, one is spare.**
 - Reinstall the clean or spare cartridge back onto the spa tub wall but turning it on clockwise. (Fig.1.3)

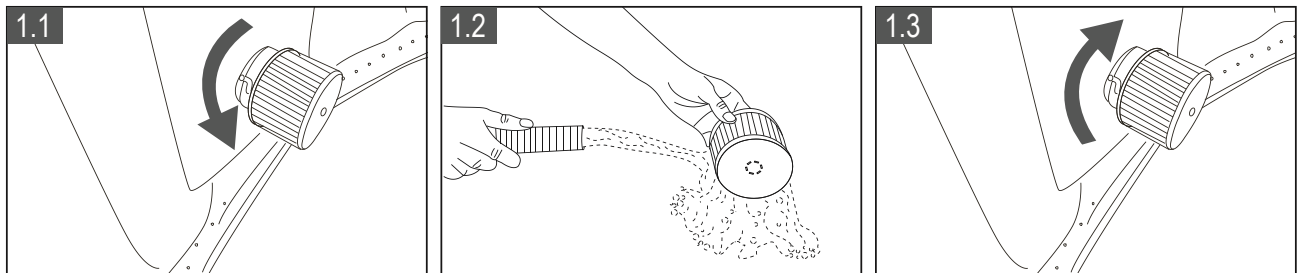

2. Change the spa water every 3-5 days depends on the spa use. See "Cleaning, draining and storage" section for instruction.
3. Use spa chemicals to maintain proper water chemistry. Spa damage resulting from misuse of chemicals and mismanagement of spa water is not covered by the warranty. Consult with your local spa or pool retailer for more information on chemical use.

4. All occupants must shower before entering the spa.

5. When spa inlet or outlet is stuck with dirt. Use the Wrench to check the problem and clean the inlet or outlet.



Water Balance

Maintain the spa water pH level between 7.2 and 7.8, total alkalinity between 80 and 120ppm and free chlorine level between 3 to 5ppm. Use the *optional Test Strips to test the spa water chemistry before each use of the spa and continue to test the water no less than once a week.

The Test Strips can test the “Free Chlorine”, “pH”, and “Total Alkalinity” level at the same time:

1. Dip the entire strip into the water and remove immediately
2. Hold the strip level for 15 seconds. Do not shake excess water from the strip
3. Compare the strip pad to the color chart on the packaging label. If necessary, adjust the chemical level in the pool water

NOTE:

- Low pH will damage the spa tub and pump. Damage resulting from the chemical imbalance will void the warranty.
- High pH (hard water) will result in white coagulations inside the filter pump; which may lead to pump damage.

WATER TREATMENT:

- Press the  Bubble button on the spa control panel to turn on the bubble air blower and help to dissolve the chemicals into the water.
- Never mix chemicals together. Add the chemicals to the spa water separately. Thoroughly dissolve each chemical before adding one to the water.
- Bromine or chlorine is highly recommended for good water quality.
- Please note that chlorine and bromine products should never be mixed. This is extremely dangerous. If you usually use chlorine-based products and you want to switch to bromine-based products, or vice versa, it is mandatory to completely change the spa water before any product changes.
- Do not over use the chemicals, otherwise there will be strong chemical odor and potential hazard to your skin.

DRAINAGE, CLEANING AND STORAGE

Spa Drainage

1. Turn off all the buttons (heater, filter and bubble) on the control panel unit.
2. Connect the drain valve adapter to a garden hose and point the other end of the garden hose to a suitable draining area with local environmental regulations (Fig.1)
3. Remove the drain valve cap from the outside of the spa tub and attach the drain valve adapter with the garden hose to the drain valve (Fig.2)
4. From the inside of the spa tub, open the drain valve cap, water will start to flow out through the garden hose (Fig.3)
5. When the water stops draining, lift the spa tub wall from the opposite to the drain, leading any remaining water to the drain and empty the spa water completely. (Fig.4)
6. Press  Bubble button to dry out any water in the piping system. Operate the bubbling function for 15 minutes to blow out all the remaining water. (Fig.5)
7. When the water stops draining, use a clean towel to wipe up any remaining water and moisture on the spa tub and spa control panel. (Fig.6)

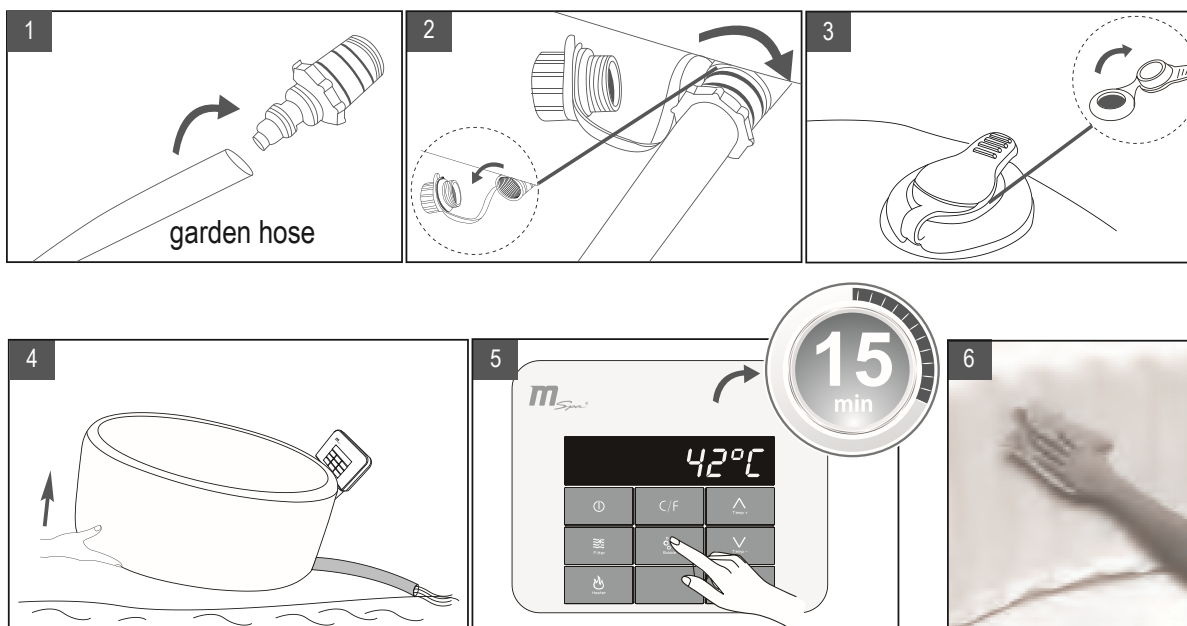

Spa Tub Cleaning

If dirt is visible in the water or water becomes cloudy and proper water chemistry does not clear it up, change the water and clean the spa tub.

While spa water is empty, remove the cartridge from the inside of the spa tub wall, clean and /or replace the filter cartridge. Use a sponge and mild soap solution to wipe away any soil or stains on the inside of the spa wall. Rinse thoroughly before refilling with clean water.

IMPOTANT: Do not use steel wool, hard brushes or abrasive cleaners.

Spa Tub and Air Bladder Repair

Use the enclosed repair patch to repair any puncture:

1. Clean and dry the area to be repaired thoroughly
2. Apply the glue to the PVC patch and quickly attach it onto the damaged surface. (Glue is not included)
3. Smooth the surface to remove any air bubbles and allow it dry for 5-10 minutes

NOTE: Glue is not included.



Storage and Prepare for the Next Time Use

1. Drain and clean the spa by following the “Drainage” and “Spa Cleaning” sections
2. Reserve the set up instructions to deflate and disassemble the spa tub, spa control unit and air bladder
3. Make sure all the spa components and accessories are thoroughly clean and dry before storage. Air-dry the spa tub in the mild sun for an hour before folding
4. Fold the spa tub loosely and avoid any sharp corners to prevent damage or leakage to the spa liner
5. Prepare new additional cartridge for next time use
6. Store the spa and accessories in a dry, temperature controlled, between 0°C - 40°C (32°F - 104°F) storage location
7. Original packaging is recommended to be used for storage

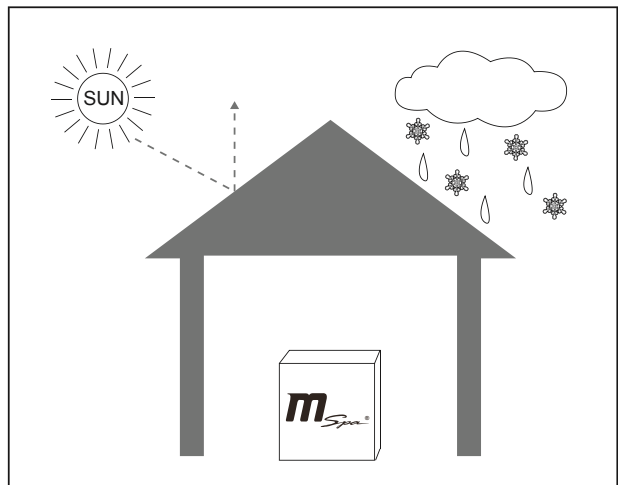

DISPOSAL and ENVIRONMENTAL PROTECTION

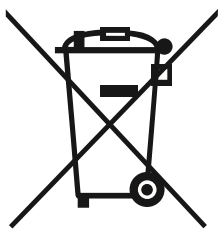

This marking indicates this product should not be disposed with other household wastes. To prevent possible harm to the environment or human health from uncontrolled waste disposal, recycle it responsibly to promote the sustainable reuse of material resources. You can obtain information on disposal from your local authorities.

To return your used device, please use the return and collection systems or contact the retailer where the product was purchased. They can take this product for environmental safe recycling.

TROUBLESHOOTING

PROBLEM	CAUSE	SOLUTION
NO DISPLAY ON THE CONTROL PANEL	Power failure	Check power source
	PRCD is off	Reset PRCD
	PRCD broken	Contact the MSpa Service Center
	Press the Reset button, control panel is not displayed	Contact the MSpa Service Center
	Digital cable connection failure 	Connect the digital cable once again, ensure the pins inside are well connected
NOT HEATING PROPERLY	Temperature set too low	Set a higher temperature
	Dirty filter cartridge	Clean or replace the filter cartridge
	Water level is not at the minimum water line	Add more water to the minimum line
	Heater failure	Contact the MSpa Service Center
	Filter pump broken	Contact the MSpa Service Center
BUBBLE AIR BLOWER DOES NOT WORK	Digital cable connection failure	Connect the digital cable once again, ensure the pins inside are well connected
	Auto-off 10 minutes	Wait for 10 minutes
	Unidirectional threshold is not open	Contact the MSpa Service Center
	Control panel failure	Contact the MSpa Service Center
OZONATOR FAILURE	Digital cable connection failure	Connect the digital cable once again, ensure the pins inside are well connected
	Water level is at the minimum water line	Add more water to the minimum line
	One-way valve blocked	Contact the MSpa Service Center
	Filter pump does not work	Refer to "FILTER PUMP DOES NOT WORK" section

PROBLEM	CAUSE	SOLUTION
FILTER PUMP DOES NOT WORK	Filter stuck by dirt or other objects	Clean or replace the filter cartridge
	Filter system failure	Contact the MSpa Service Center
SPA TUB IN AN ABNORMAL SHAPE	Extra air pressure by strong sunshine	Check the air pressure and release some air if necessary. During hot weather, it is recommended to check if it is necessary to release some air to avoid any possible damage to the spa pool
SPA LEAKING	Spa inlet/outlet connection not securely tight	Tighten the inlet and outlet connection
	Drainage valve is not closed completely	Contact the MSpa Service Center
	Water leaks from the spa pool body	Repair the leaking hole/spilt with the repair kit material
SPA LOOSES AIR PRESSURE	Air valve got loosen	Fill up the tub with air, make sure the air valves are secure, replace if necessary
	Hole or split on the spa tub	Put soap water in a squirt bottle and spray on seams. If there is a leak it will bubble. After you find the leak, clean and dry the leaking area, then use the repair patch comes with your spa. Check the repair section on P20
WATER NOT CLEAN	Water has been used too long	Change the water
	Insufficient filtering	Increase filtration frequency
	Dirty filter cartridge	Clean or replace the filter cartridge in time
	Improper water maintenance	Refer to the chemical manufacture's instruction

CONTACT YOUR LOCAL MSPA DEALER OR SERVICE CENTER FOR ANY PRODUCT RELATED QUESTIONS OR PROBLEMS.