



Le rogamos que envíe los productos una vez transcurrido el plazo de entrega, a través de los distribuidores autorizados.

(DT) Nicht geeignet für Kinder unter 14 Jahren. Dies ist kein Spielzeug.
 (EN) No apto para menores de 14 años. Esto no es un juguete. (FR) Ne convient pas aux enfants de moins de 14 ans. Ceci n'est pas un jouet.
 (NL) No apto para menores de 14 años. Esto no es un juguete.



Nº 40009



pi

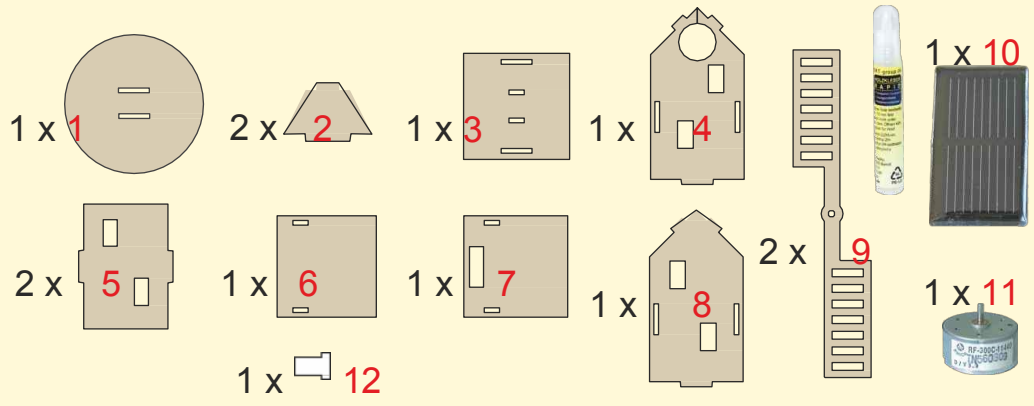

FABRICADO EN EUROPA

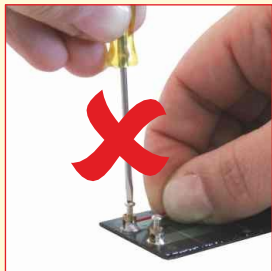
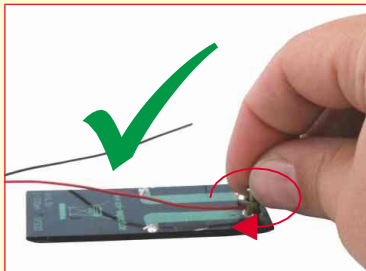

¡(DT) Die Schrauben dürfen nur leicht mit den Fingern angezogen werden! **Keinen Schraubendreher benutzen!** (GB) ¡Los tornillos deben apretarse ligeramente con los dedos! **¡No utilizar destornillador!** (FR) Les vis doivent être serrées légèrement avec vos doigts! **Ne pas utiliser de tournevis!** (NL) ¡Los tornillos deben apretarse ligeramente con los dedos! **¡No utilice un destornillador!**

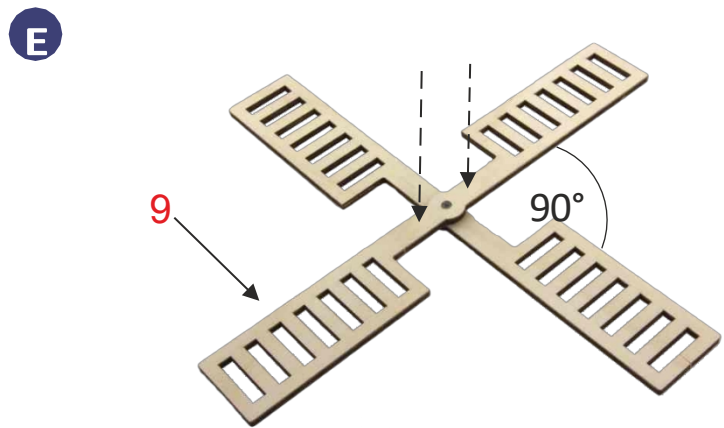
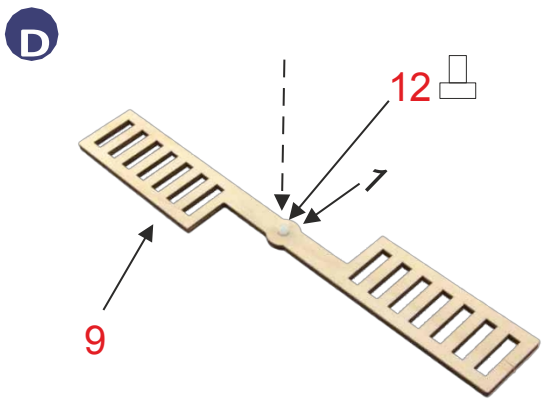
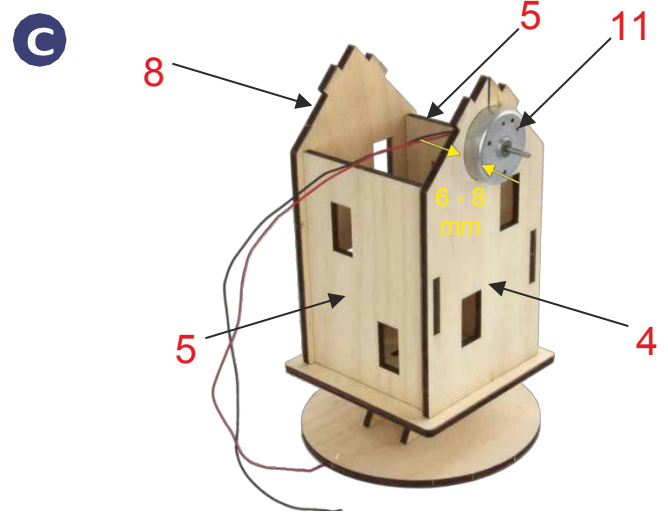
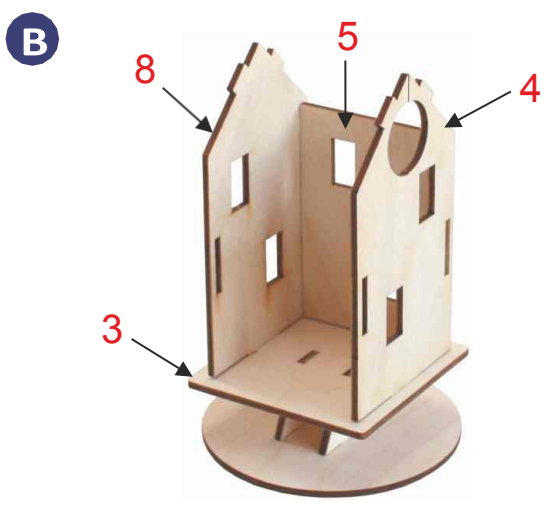
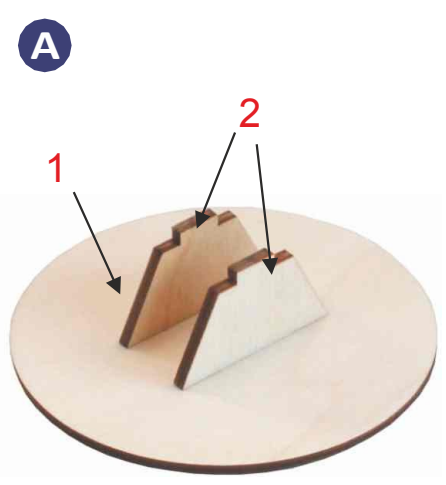

- 1 x 1
- 2 x 2
- 1 x 3
- 1 x 4
- 1 x 8
- 2 x 9
- 1 x 10
- 1 x 11
- 2 x 5
- 1 x 6
- 1 x 7
- 1 x 12

